

## ARMOIRES VESTIAIRE

## LOCKERS



FR

- Grande variété de tailles et configurations.
- Conception robuste et résistante.
- Banc en bois de pin.
- Plusieurs options disponibles pour la fermeture de l'armoire vestiaire.
- Ouverture des portes à 180 °.
- Option avec toit incliné.
- Couleur standard bleu martelé possibilité teintes en option.
- Système RFID en option.

EN

- Wide range of sizes and configurations.
- Strong and resistant design.
- Pinewood bench.
- Wide range of closure accessories available
- 180 ° opening doors.
- Optional sloped roof.
- Standard colour hammered blue possibility optional colours.
- Option RFID system.

## ARMARIOS PARA VESTUARIO



ES

- Gran variedad de medidas y configuraciones.
- Diseño robusto y resistente.
- Banco en madera de pino.
- Varios opciones de cierre de las taquillas.
- Apertura de puertas de 180 °.
- Opción con techo inclinado.
- Color estándar azul martelé posibilidad colores en opción.
- Cierre electrónico. Sistema RFID opcional.



**SERIE 156 BV** ref. 156 BV 10 / 156 BV 15 / 156 BV 20

Bancos para vestuario.  
Bancs pour vestiaire.  
Cloakroom benches.



156 BV 10

156 BV 15

156 BV 20

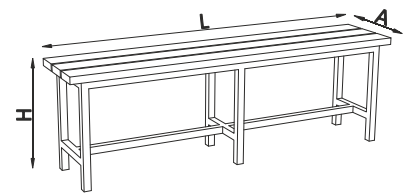

		LxAxH
156 BV 10	11 Kg	900x320x480
156 BV 15	19 Kg	1500x320x480
156 BV 20	23 Kg	2000x320x480



Asiento en madera de pino.  
Siège en bois de pin.  
Pine wood seat.

**e** 30x30x1,5 mm

**SERIE 156 BV 10** STANDARD

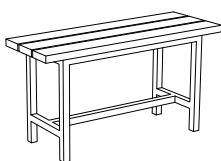

		LxAxH
156 BV 10	11 Kg	900 x 320 x 480

**SERIE 156 BV 15** STANDARD

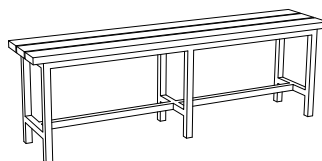

		LxAxH
156 BV 15	19 Kg	1500 x 320 x 480

**SERIE 156 BV 20** STANDARD

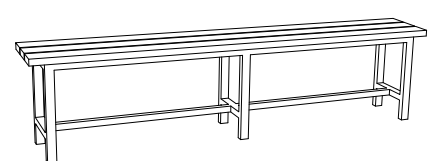

		LxAxH
156 BV 20	23 Kg	2000 x 320 x 480

SERIE 155 / 156

Armario para vestuario con o sin techo inclinado.  
Armoire vestiaire avec ou sans toit incliné.  
Cloakroom wardrobes with or without sloped roof.

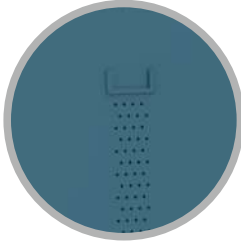

Portaetiquetas y agujeros de ventilación.  
Porte - étiquettes et trous de ventilation.  
Label holder and ventilation holes.

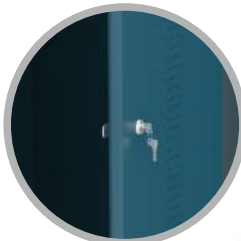

Cierre con llave.  
Fermeture à clé.  
Key locking.



TI: Con techo inclinado  
TI: Avec toit incliné.  
TI: With sloped roof.

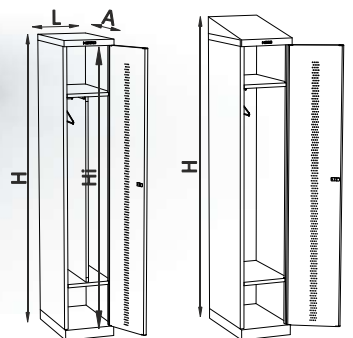

OPCIONES OPTIONS/ OPTIONS

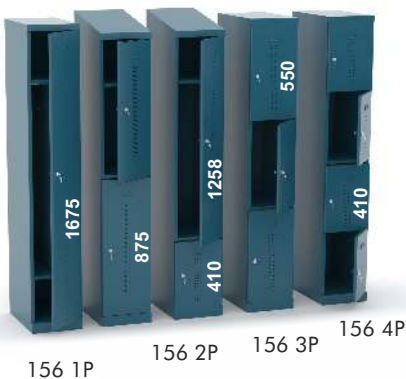

SERIE 155  
SERIE 155 TI

SERIE 156  
SERIE 156 TI

INFO

SERIE 155  
L = 400mm

SERIE 156  
L = 300mm

SERIE 155 TI / SERIE 156 TI



TI: Con techo inclinado  
TI: Avec toit incliné.  
TI: With sloped roof.

		L x A x H	Hi (mm)
155	30 Kg	400x500x1800	1700
155 TI	33 Kg	400x500x2000	1700
156	28 Kg	300x500x1800	1700
156 TI	31 Kg	300x500x2000	1700

- e** 0,8 mm estructura chasis / frame
- e** 0,7 mm estanteria étagère / shelf
- e** 0,6 mm puerta porte / door

OPCIONES DE CIERRE CHOIX FERMETURE / OPTIONS CLOSURE

156 CC

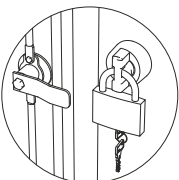

156 C3P

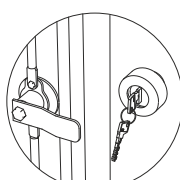

156 CM



156 CCN

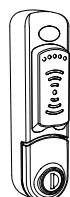

CE P 1



Para más información de cierres, ver PAG. 293-295.  
Pour plus information de verrou, voir PAG. 293-295.  
For further information of lock, see PAG. 293-295.

ACCESORIOS ACCESOIRES / ACCESSORIES

156 B

**25** Estanteria remachada  
Étagère rivetée  
Riveted shelf

156 SC

Separador central  
(solo para taquilla una puerta).  
Séparateur centrale  
(seulement pour armoire une porte).  
Central divider  
(only for cabinet one door).

156 P

Juego de 2 unidades  
Jeu de 2 unités  
2 units set

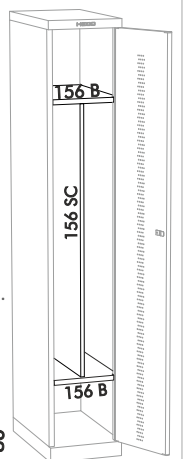

# SERIE 155 (TI)-156 (TI) STANDARD

1 PUERTA  
1 PORTE  
1 DOOR



TI: Con techo inclinado  
TI: Avec toit incliné.  
TI: With sloped roof.

estantería para perchas  
étagère porte manteau  
hanger shelf

estantería fija  
étagère fixe  
fixed shelf

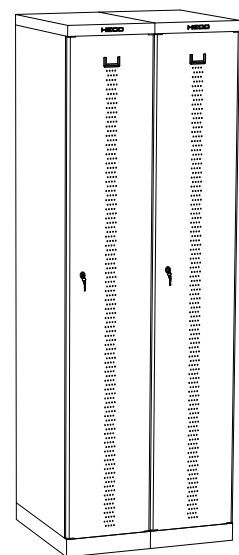
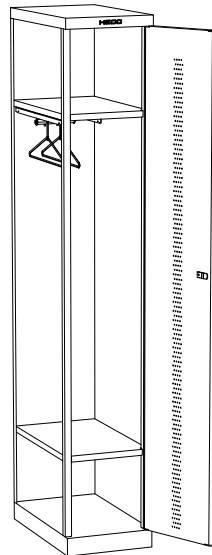
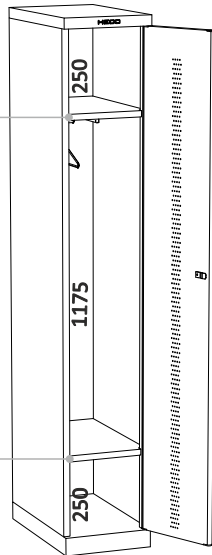

L x A x H		
155 11	30 Kg	400 x 500 x 1800
156 11	28 Kg	300 x 500 x 1800
155 TI 11	33 Kg	400 x 500 x 2000
156 TI 11	31 Kg	300 x 500 x 2000

modulo base module de base / basic module

accesorios / accessoires / accessories	
2x 156 P	patas / pieds / stands

L x A x H		
155 12	27 Kg	400 x 500 x 1800
156 12	25 Kg	300 x 500 x 1800
155 TI 12	30 Kg	400 x 500 x 2000
156 TI 12	28 Kg	300 x 500 x 2000

modulo adicional module additionnel / additional module

accesorios / accessoires / accessories	
2x 156 P	patas / pieds / stands

L x A x H		
155 11 2	57 Kg	800 x 500 x 1800
156 11 2	53 Kg	600 x 500 x 1800
155 TI 11 2	63 Kg	800 x 500 x 2000
156 TI 11 2	59 Kg	600 x 500 x 2000

composición composition / composition

accesorios / accessoires / accessories	
2x 156 P	patas / pieds / stands

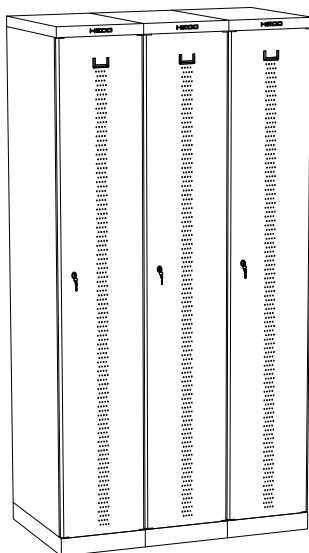

L x A x H		
155 11 3	91,5 Kg	1200 x 500 x 1800
156 11 3	81 Kg	900 x 500 x 1800
155 TI 11 3	100,5 Kg	1200 x 500 x 2000
156 TI 11 3	90 Kg	900 x 500 x 2000

composición composition / composition

accesorios / accessoires / accessories	
2x 156 P	patas / pieds / stands

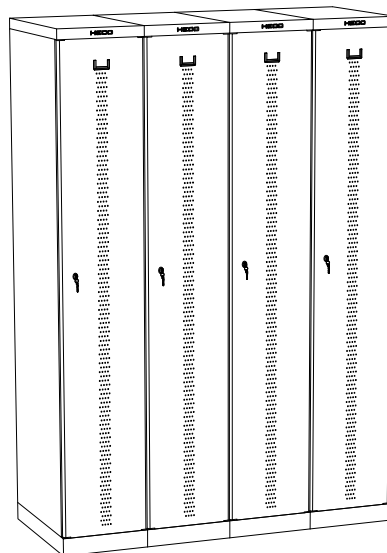

L x A x H		
155 11 4	122 Kg	1600 x 500 x 1800
156 11 4	110,5 Kg	1200 x 500 x 1800
155 TI 11 4	134 Kg	1600 x 500 x 2000
156 TI 11 4	122,5 Kg	1200 x 500 x 2000

composición composition / composition

accesorios / accessoires / accessories	
3x 156 P	patas / pieds / stands

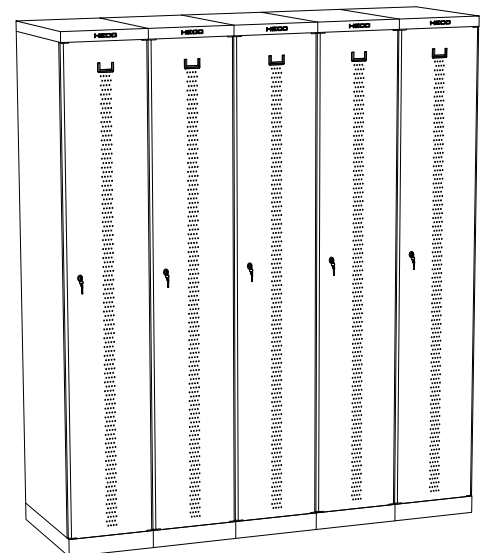

L x A x H		
155 11 5	154 Kg	2000 x 500 x 1800
156 11 5	141 Kg	1500 x 500 x 1800
155 TI 11 5	169 Kg	2000 x 500 x 2000
156 TI 11 5	156 Kg	1500 x 500 x 2000

composición composition / composition

accesorios / accessoires / accessories	
4x 156 P	patas / pieds / stands

SERIE 155 (TI)-156 (TI) STANDARD



TI: Con techo inclinado  
TI: Avec toit incliné.  
TI: With sloped roof.

2 PUERTAS  
2 PORTES  
2 DOORS



estantería para perchas  
étagère porte manteau  
hanger shelf

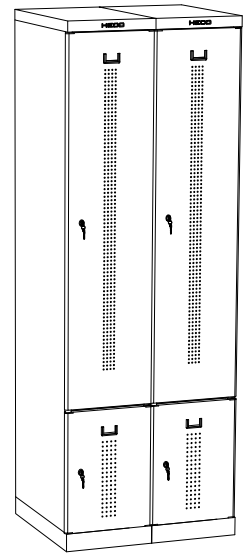
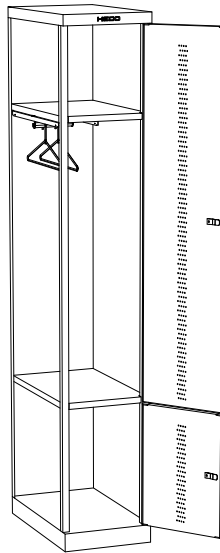
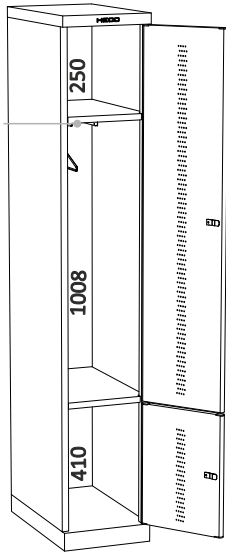

		L x A x H
155 2P 1	32 Kg	400 x 500 x 1800
156 2P 1	30,3 Kg	300 x 500 x 1800
155 TI 2P 1	35 Kg	400 x 500 x 2000
156 TI 2P 1	33.3 Kg	300 x 500 x 2000

modulo base module de base / basic module

accesorios / accessoires / accessories	
2x 156 P	patas / pieds / stands

		L x A x H
155 2P 2	29 Kg	400 x 500 x 1800
156 2P 2	27,3 Kg	300 x 500 x 1800
155 TI 2P 2	32 Kg	400 x 500 x 2000
156 TI 2P 2	30,3 Kg	300 x 500 x 2000

modulo adicional module additionnel / additional module

accesorios / accessoires / accessories	
2x 156 P	patas / pieds / stands

		L x A x H
155 2P 1 2	61 Kg	800 x 500 x 1800
156 2P 1 2	57,6 Kg	600 x 500 x 1800
155 TI 2P 1 2	67 Kg	800 x 500 x 2000
156 TI 2P 1 2	63.6 Kg	600 x 500 x 2000

composición composition / composition

accesorios / accessoires / accessories	
2x 156 P	patas / pieds / stands

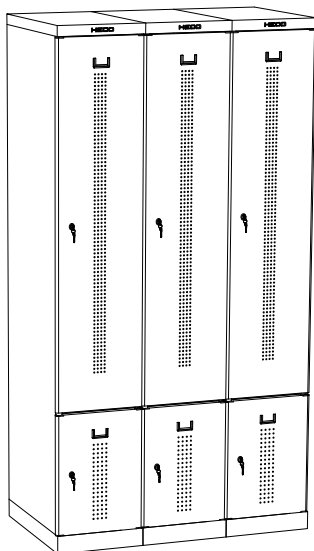

		L x A x H
155 2P 1 3	90,9 Kg	1200 x 500 x 1800
156 2P 1 3	84.9 Kg	900 x 500 x 1800
155 TI 2P 1 3	99,9 Kg	1200 x 500 x 2000
156 TI 2P 1 3	93,9 Kg	900 x 500 x 2000

composición composition / composition

accesorios / accessoires / accessories	
2x 156 P	patas / pieds / stands

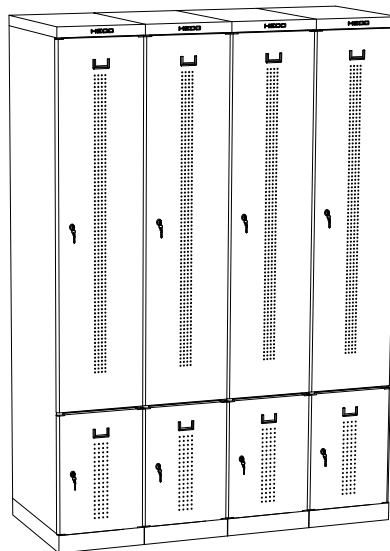

		L x A x H
155 2P 1 4	123,2 Kg	1600 x 500 x 1800
156 2P 1 4	111,2 Kg	1200 x 500 x 1800
155 TI 2P 1 4	135,7 Kg	1600 x 500 x 2000
156 TI 2P 1 4	123,2 Kg	1200 x 500 x 2000

composición composition / composition

accesorios / accessoires / accessories	
3x 156 P	patas / pieds / stands

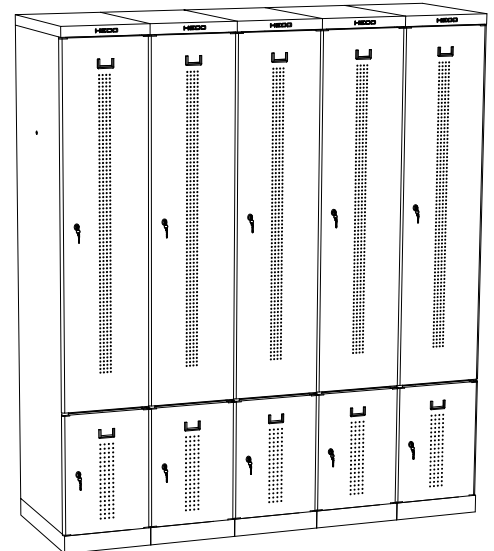

		L x A x H
155 2P 1 5	141.5 Kg	2000 x 500 x 1800
156 2P 1 5	138,5 Kg	1500 x 500 x 1800
155 TI 2P 1 5	156,5 Kg	2000 x 500 x 2000
156 TI 2P 1 5	130 Kg	1500 x 500 x 2000

composición composition / composition

accesorios / accessoires / accessories	
4x 156 P	patas / pieds / stands

# SERIE 155 (TI)-156 (TI) STANDARD

2 PUERTAS  
2 PORTES  
2 DOORS



**i** TI: Con techo inclinado  
TI: Avec toit incliné.  
TI: With sloped roof.

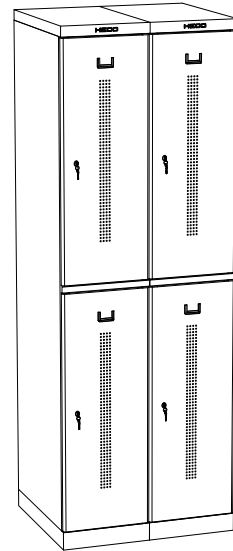
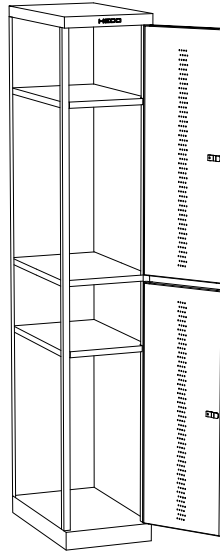
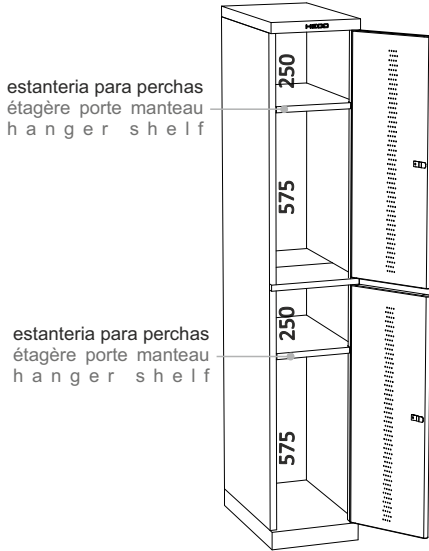

L x A x H		
155 21	31 Kg	400 x 500 x 1800
156 21	29 Kg	300 x 500 x 1800
155 TI 21	34 Kg	400 x 500 x 2000
156 TI 21	32 Kg	300 x 500 x 2000

modulo base module de base / basic module

accesorios / accessoires / accessories	
2x 156 P	patas / pieds / stands

L x A x H		
155 22	28 Kg	400 x 500 x 1800
156 22	26 Kg	300 x 500 x 1800
155 TI 22	31 Kg	400 x 500 x 2000
156 TI 22	29 Kg	300 x 500 x 2000

modulo adicional module additionnel / additional module

accesorios / accessoires / accessories	
2x 156 P	patas / pieds / stands

L x A x H		
155 21 2	59 Kg	800 x 500 x 1800
156 21 2	55 Kg	600 x 500 x 1800
155 TI 21 2	65 Kg	800 x 500 x 2000
156 TI 21 2	61 Kg	600 x 500 x 2000

composición composition / composition

accesorios / accessoires / accessories	
2x 156 P	patas / pieds / stands

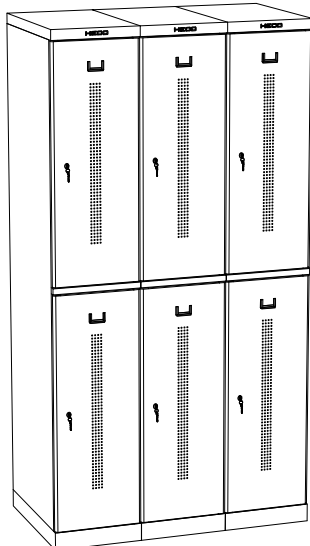

L x A x H		
155 21 3	94,5 Kg	1200 x 500 x 1800
156 21 3	88,5 Kg	900 x 500 x 1800
155 TI 21 3	103,5 Kg	1200 x 500 x 2000
156 TI 21 3	97,5 Kg	900 x 500 x 2000

composición composition / composition

accesorios / accessoires / accessories	
2x 156 P	patas / pieds / stands

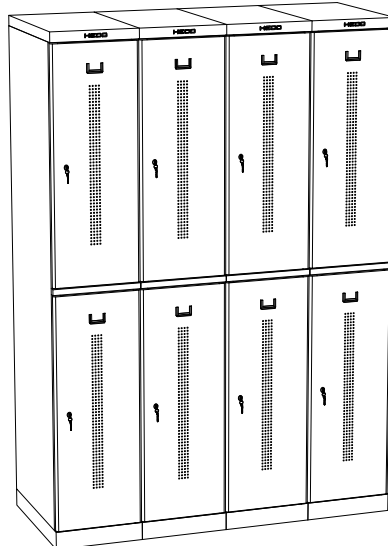

L x A x H		
155 21 4	126 Kg	1600 x 500 x 1800
156 21 4	114,5 Kg	1200 x 500 x 1800
155 TI 21 4	138 Kg	1600 x 500 x 2000
156 TI 21 4	126,5 Kg	1200 x 500 x 2000

composición composition / composition

accesorios / accessoires / accessories	
3x 156 P	patas / pieds / stands

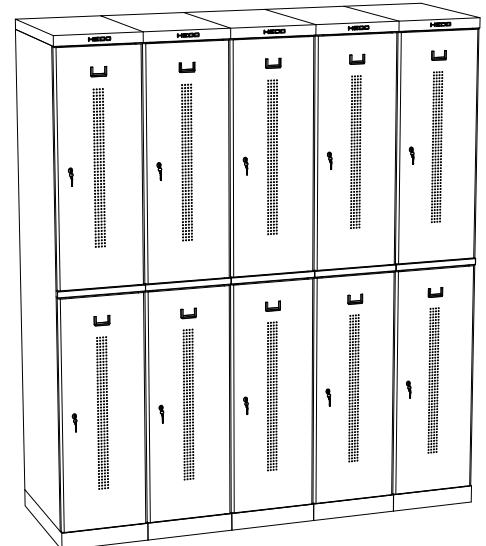

L x A x H		
155 21 5	159 Kg	2000 x 500 x 1800
156 21 5	146 Kg	1500 x 500 x 1800
155 TI 21 5	174 Kg	2000 x 500 x 2000
156 TI 21 5	161 Kg	1500 x 500 x 2000

composición composition / composition

accesorios / accessoires / accessories	
4x 156 P	patas / pieds / stands

SERIE 155 (TI)-156 (TI) STANDARD



TI: Con techo inclinado  
TI: Avec toit incliné.  
TI: With sloped roof.

3 PUERTAS  
3 PORTES  
3 DOORS

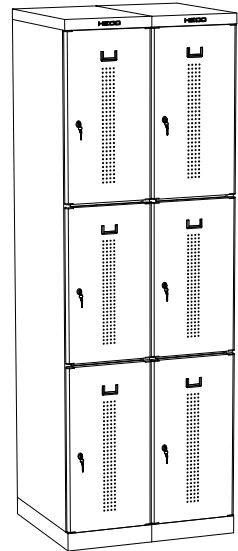
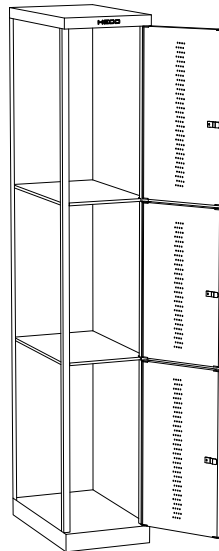
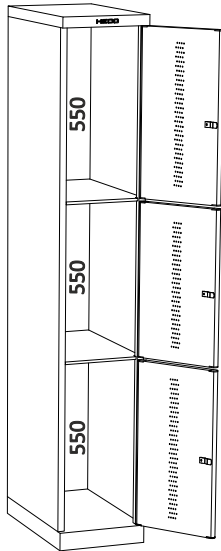

		LxAxH	
155 31	31 Kg	400 x 500 x 1800	
156 31	30 Kg	300 x 500 x 1800	
155 TI 31	34 Kg	400 x 500 x 2000	
156 TI 31	33 Kg	300 x 500 x 2000	

modulo base module de base / basic module

accesorios / accessoires / accessories	
2x 156 P	patas / pieds / stands

		LxAxH	
155 32	28 Kg	400 x 500 x 1800	
156 32	27 Kg	300 x 500 x 1800	
155 TI 32	31 Kg	400 x 500 x 2000	
156 TI 32	30 Kg	300 x 500 x 2000	

modulo adicional module additionnel / additional module

accesorios / accessoires / accessories	
2x 156 P	patas / pieds / stands

		LxAxH	
155 31 2	59 Kg	800 x 500 x 1800	
156 31 2	57 Kg	600 x 500 x 1800	
155 TI 31 2	65 Kg	800 x 500 x 2000	
156 TI 31 2	63 Kg	600 x 500 x 2000	

composición composition / composition

accesorios / accessoires / accessories	
2x 156 P	patas / pieds / stands

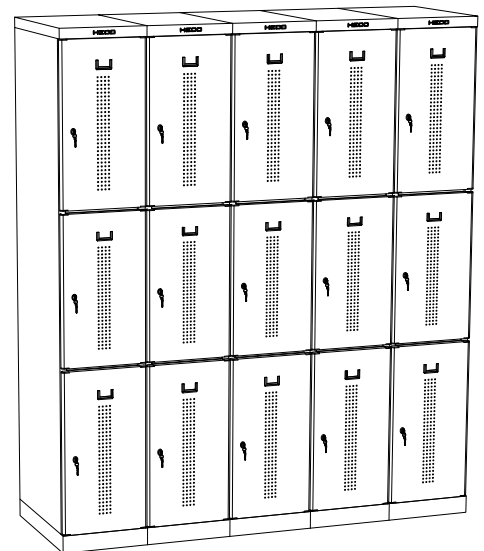
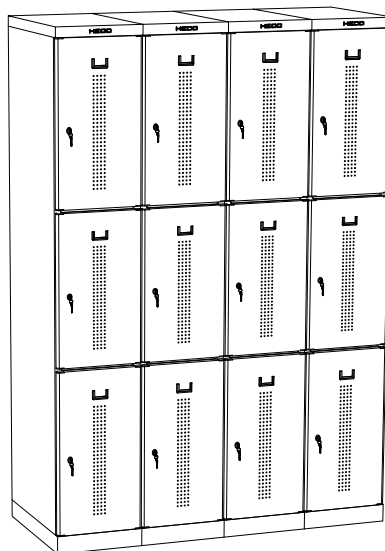
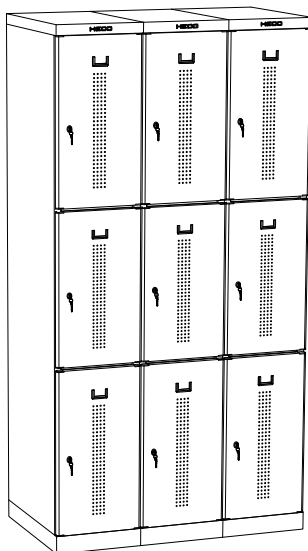

		LxAxH	
155 31 3	94,5 Kg	1200 x 500 x 1800	
156 31 3	87 Kg	900 x 500 x 1800	
155 TI 31 3	103,5 Kg	1200 x 500 x 2000	
156 TI 31 3	96 Kg	900 x 500 x 2000	

composición composition / composition

accesorios / accessoires / accessories	
2x 156 P	patas / pieds / stands

		LxAxH	
155 31 4	126 Kg	1600 x 500 x 1800	
156 31 4	118,5 Kg	1200 x 500 x 1800	
155 TI 31 4	138 Kg	1600 x 500 x 2000	
156 TI 31 4	130,5 Kg	1200 x 500 x 2000	

composición composition / composition

accesorios / accessoires / accessories	
3x 156 P	patas / pieds / stands

		LxAxH	
155 31 5	159 Kg	2000 x 500 x 1800	
156 31 5	151 Kg	1500 x 500 x 1800	
155 TI 31 5	174 Kg	2000 x 500 x 2000	
156 TI 31 5	166 Kg	1500 x 500 x 2000	

composición composition / composition

accesorios / accessoires / accessories	
4x 156 P	patas / pieds / stands



# SERIE 155 (TI)-156 (TI) STANDARD



TI: Con techo inclinado  
 TI: Avec toit incliné.  
 TI: With sloped roof.

4 PUERTAS  
 4 PORTES  
 4 DOORS

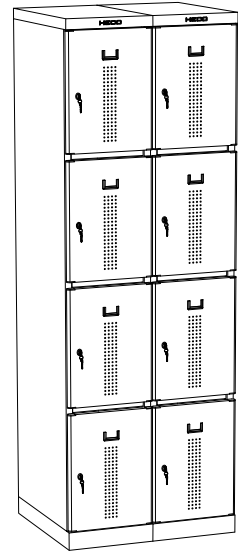
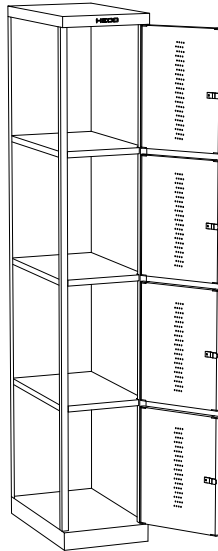
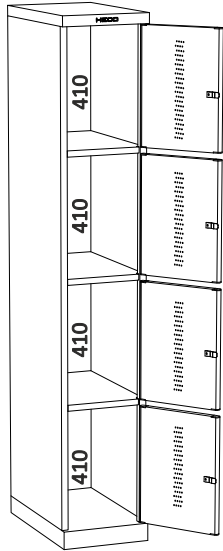

LxAxH		
155 41	33 Kg	400 x 500 x 1800
156 41	30 Kg	300 x 500 x 1800
155 TI 41	36 Kg	400 x 500 x 2000
156 TI 41	33 Kg	300 x 500 x 2000

modulo base module de base / basic module

accesorios / accessoires / accessories	
2x 156 P	patas / pieds / stands

LxAxH		
155 42	30 Kg	400 x 500 x 1800
156 42	27 Kg	300 x 500 x 1800
155 TI 42	33 Kg	400 x 500 x 2000
156 TI 42	30 Kg	300 x 500 x 2000

modulo adicional module additionnel / additional module

accesorios / accessoires / accessories	
2x 156 P	patas / pieds / stands

LxAxH		
155 41 2	63 Kg	800 x 500 x 1800
156 41 2	57 Kg	600 x 500 x 1800
155 TI 41 2	68 Kg	800 x 500 x 2000
156 TI 41 2	57 Kg	600 x 500 x 2000

composición composition / composition

accesorios / accessoires / accessories	
2x 156 P	patas / pieds / stands

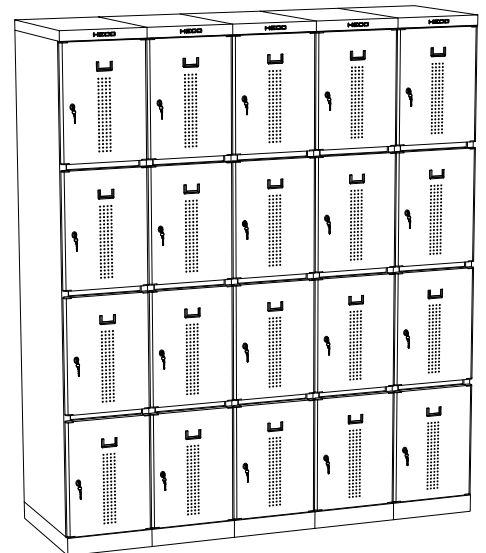
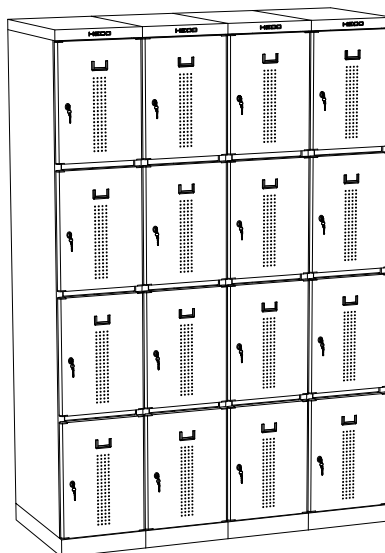
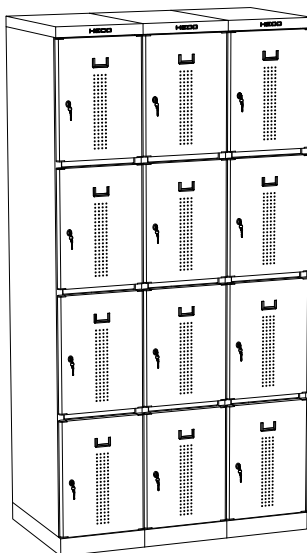

LxAxH		
155 41 3	101 Kg	1200 x 500 x 1800
156 41 3	87 Kg	900 x 500 x 1800
155 TI 41 3	110 Kg	1200 x 500 x 2000
156 TI 41 3	96 Kg	900 x 500 x 2000

composición composition / composition

accesorios / accessoires / accessories	
2x 156 P	patas / pieds / stands

LxAxH		
155 41 4	134 Kg	1600 x 500 x 1800
156 41 4	118,5 Kg	1200 x 500 x 1800
155 TI 41 4	146 Kg	1600 x 500 x 2000
156 TI 41 4	130,5 Kg	1200 x 500 x 2000

composición composition / composition

accesorios / accessoires / accessories	
3x 156 P	patas / pieds / stands

LxAxH		
155 41 5	169 Kg	2000 x 500 x 1800
156 41 5	151 Kg	1500 x 500 x 1800
155 TI 41 5	184 Kg	2000 x 500 x 2000
156 TI 41 5	166 Kg	1500 x 500 x 2000

composición composition / composition

accesorios / accessoires / accessories	
4x 156 P	patas / pieds / stands

**SERIE 160 TI**

Almacenaje para ropa limpia.  
Stockage de linge propre.  
Clean laundry storage.



**STANDARD**

Cierre con llave incluido.  
Fermeture à clé inclus.  
Key locking included.



APERTURA OUVERTURE OPENING

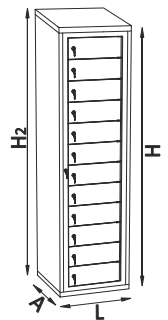
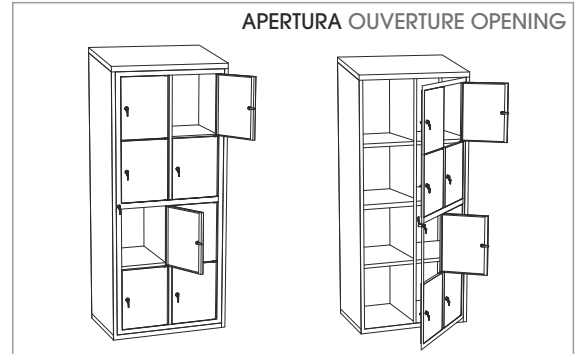

Con techo inclinado.  
Avec toit incliné.  
With sloped roof.



Para más información de cierres, ver PAG. 291-294.  
Pour plus information de verrous, voir PAG. 291-294.  
For further information of locks, see PAG. 291-294.

		L x A x H x H2 (mm)
160 (1)	54 Kg	500x500x1800x1890
160 (2)	54 Kg	800x500x1800x1890
160 16	68 Kg	500x500x2285x2375

1 mm

**SERIE 160 STANDARD**

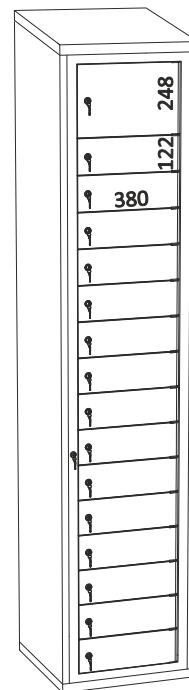
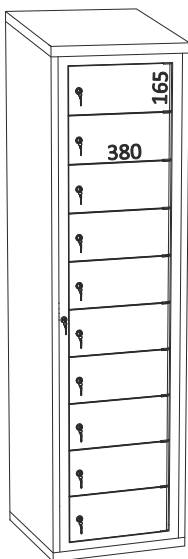

		L x A x H x H2
160 10 1 TI	54 Kg	500 x 500 x 1800 x 1890

		L x A x H x H2
160 12 1 TI	54 Kg	500 x 500 x 1800 x 1890

		L x A x H x H2
160 16 1 TI	68 Kg	500 x 500 x 2285 x 2375

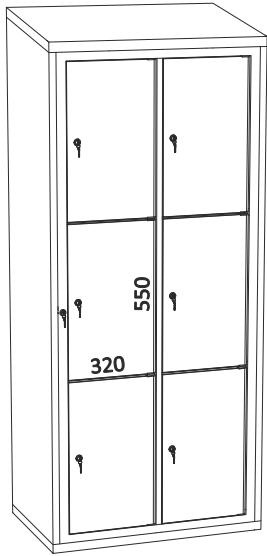

L x A x H x H <sub>2</sub>		
160 6 TI	67 Kg	800 x 500 x 1800 x 1890



L x A x H x H <sub>2</sub>		
160 8 TI	71 Kg	800 x 500 x 1800 x 1890

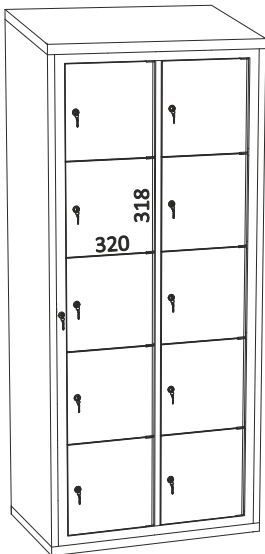

L x A x H x H <sub>2</sub>		
160 10 2 TI	75 Kg	800 x 500 x 1800 x 1890

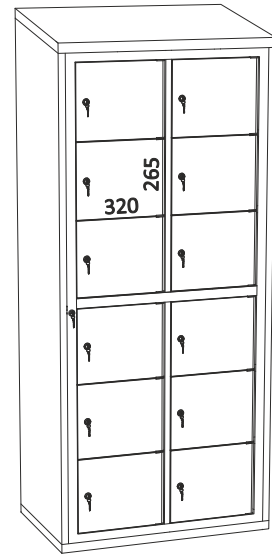

L x A x H x H <sub>2</sub>		
160 12 2 TI	76 Kg	800 x 500 x 1800 x 1890

SERIE 160 0 / 160 1 TI

Almacenaje de ropa para lavar  
Stockage des vêtements à laver.  
Storage of washing clothes.



SERIE 160 0

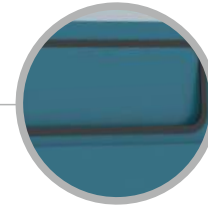
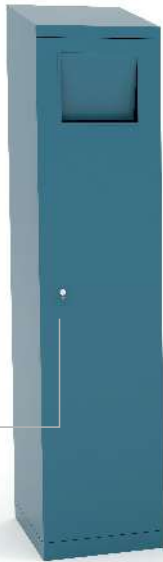

Protección.  
Protection.  
Protection.

STANDARD  
Cierre con llave.  
Fermeture à clé.  
Key locking.



SERIE 160 1

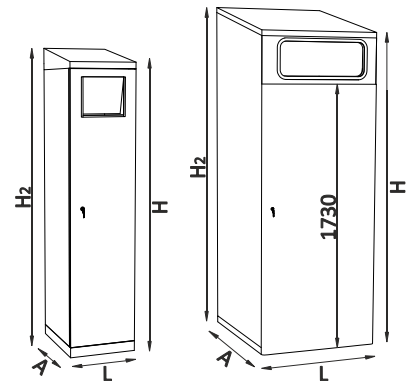

Puerta batiente para el depósito de ropa.  
Porte battante pour déposer les vêtements.  
Swing door for clothing deposit.



Con ganchos para sostener el saco de ropa.  
Avec des crochets pour tenir le sac de vêtements.  
With hooks to hold the bag of clothes.

		L x A x H x H2
160 0	28,5 Kg	400x500x1800x1890
160 1 TI	89 Kg	800x900x2070x2280

1 mm

SERIE 160 0 STANDARD

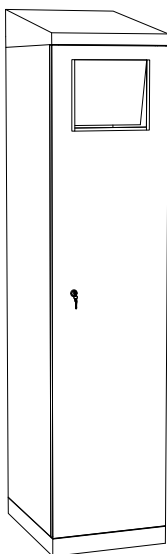

		L x A x H x H2
160 0	28,5 Kg	400 x 500 x 1800 x 1890

SERIE 160 1 TI STANDARD

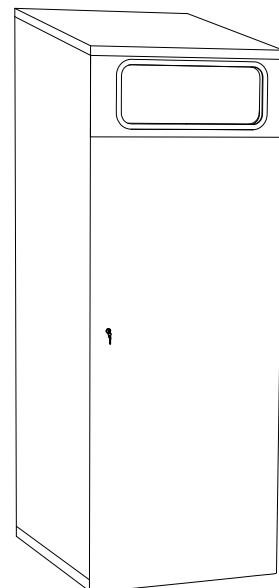

		L x A x H x H2
160 1 TI	89 Kg	800 x 900 x 2070 x 2280

**SERIE 163** ref. 163 1 / 163 2

Armarios para vestuario.  
Armoires vestiaire.  
Cloakroom wardrobes.



163 1



163 2

**Descripción. Description. Description.**

Armario con pies de alta resistencia. 1 o 2 puertas. Cierre con llave incluido. Ventilación. Color opcional.  
Armoire avec pieds de haute résistance. 1 ou 2 portes. Fermeture avec clé inclus. Ventilation. Couleur en option.  
Cabinet with stands high resistance. 1 or 2 doors. Key locking included. Ventilation. Choice of colours.

**Detalles. Détails. Details.**

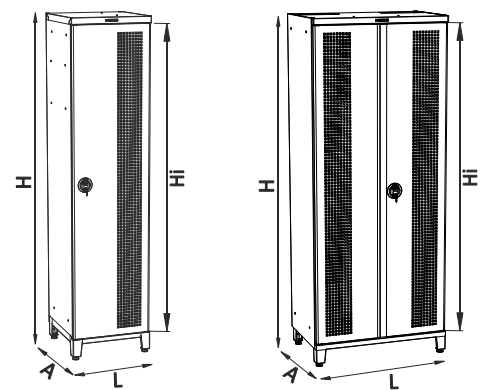

		L x A x H	Hi (mm)
163 1	61 Kg	450x500x2000	1800
163 2	97,55 Kg	900x500x2000	1800

**e** 1 mm estructura chasis / frame  
**e** 0,6 mm puerta porte / door



Opcional. Ver: PAG 291.  
Optionnel. Voir: PAG 291.  
Optional. See: PAGE 291.

SERIE 163 1 STANDARD

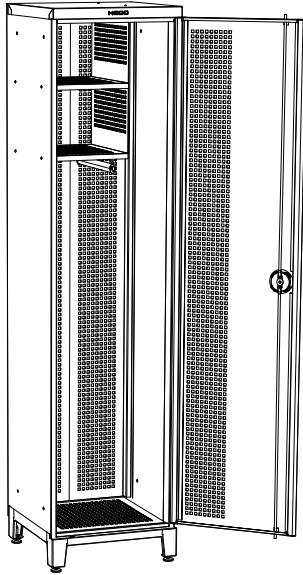

		LxAxH
163 1	61 Kg	450 x 500 x 2000

SERIE 163 2 STANDARD

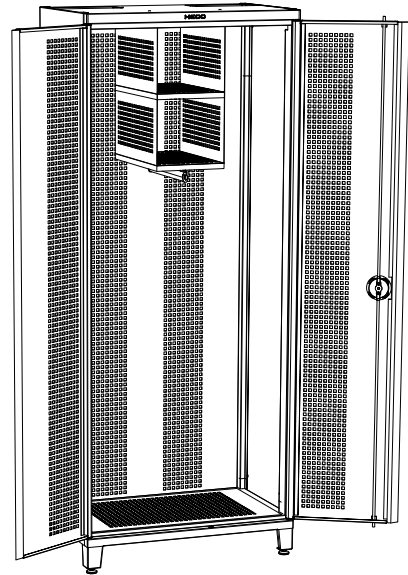

		LxAxH
163 2	97,55 Kg	900 x 500 x 2000

INFO

CIERRE ELECTRONICO RFID / VERROU ELÉCTRONIQUE RFID / RFID ELECTRONIC LOCKING

SERIE CE P 1



·Indicadores LED.  
·Indicateurs LED.  
·LED display.



·Tarjetas usuario abrir/cerrar.  
·Cartes utilisateur pour ouvrir/fermer.  
·Cards for opening/closing doors.

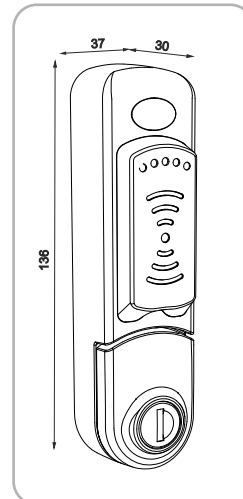

·Medidas.  
·Mesures.  
·Measures.



Para más información, ver PAG. 293.  
Pour plus d'information, voir PAGE. 293.  
For further information, see PAGE. 293.