

## SOLUTIONS MODULAIRES ET COMPTOIRS

## MODULAR SOLUTIONS AND COUNTERS



FR

- Grande variété de tailles et configurations.
- Conception robuste et résistante.
- Forte résistance au chargement.
- Plusieurs configurations.
- Ouverture des portes à 180 °.
- Couleur standard bleu martelé possibilité teintes en option. SÉRIE 170 (RAL 5017-RAL 2009).

EN

- Wide range of sizes and configurations.
- Strong and resistant design.
- High weight-bearing resistance.
- Several configurations.
- 180 ° opening doors.
- Standard colour hammered blue possibility optional colours. SERIE 170 (RAL 5017-RAL 2009).

## SOLUCIONES MODULARES Y MOSTRADORES



ES

- Gran variedad de medidas y configuraciones.
- Diseño robusto y resistente.
- Alta resistencia de carga.
- Varias configuraciones.
- Apertura de puertas de 180 °.
- Color estándar azul martelé posibilidad colores en opción. SERIE 170 (RAL 5017-RAL 2009).



**SERIE 115 E** ref. 115 E 1 / 115 E 2 / 115 E 3

Armarios con cajones y estanterías.  
Armoires avec tiroirs et étagères.  
Cabinets with drawers and shelves.



Sistema antivuelco.  
Système anti-renversement.  
Anti-roll system.

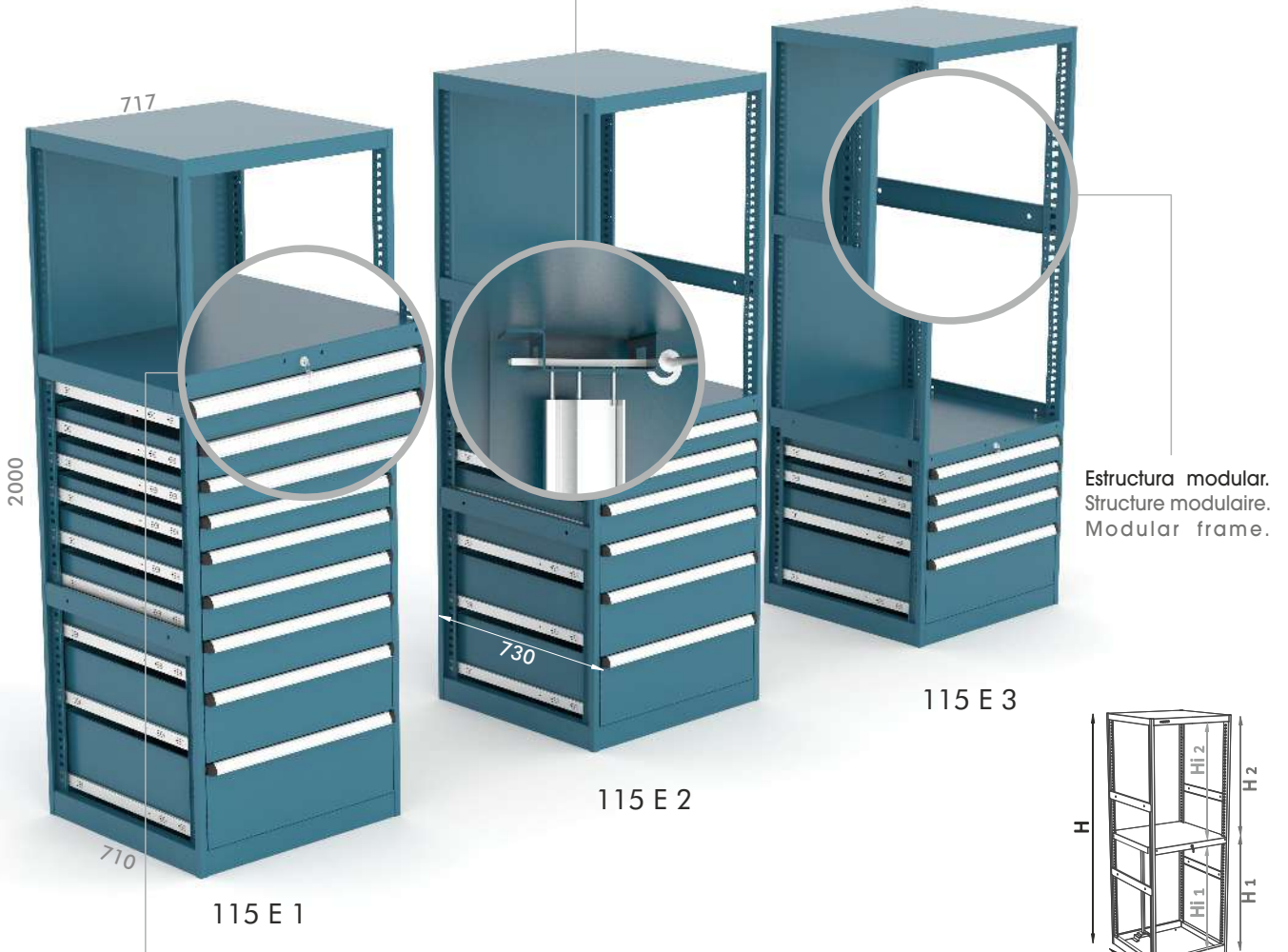

Estructura modular.  
Structure modulaire.  
Modular frame.

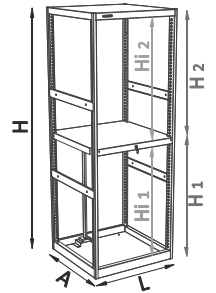

Cierre centralizado.  
Verrouillage centralisé.  
Central locking.

	LxAxH (mm)	H1 (mm)	H2 (mm)	Hi 1 (mm)	Hi 2 (mm)
115 E 1	717x710x2000	1435	600	1300	550
115 E 2	717x710x2000	1035	1000	900	950
115 E 3	717x710x2000	735	1300	600	1250

**e** 1 mm

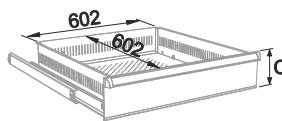

		GT	100
SERIE 115	C=50	●	115 T100 C50 10,5Kg
	C=75	●	115 T100 C75 11Kg
	C=100	●	115 T100 C100 12,5Kg
	C=125	●	115 T100 C125 13Kg
	C=150	●	115 T100 C150 13,5Kg
	C=200	●	115 T100 C200 14,5Kg
	C=250	●	115 T100 C250 15,5Kg
C=300			
		<b>e</b>	1.5 mm



Plazo de entrega 10 días laborables.  
Délai de livraison 10 jours ouvrables.  
Delivery time 10 working days.





Para más información de cajones, ver PAG. 45.  
Pour plus d'information de tiroirs, voir PAGE. 45.  
For further information of drawers, see PAGE. 45.



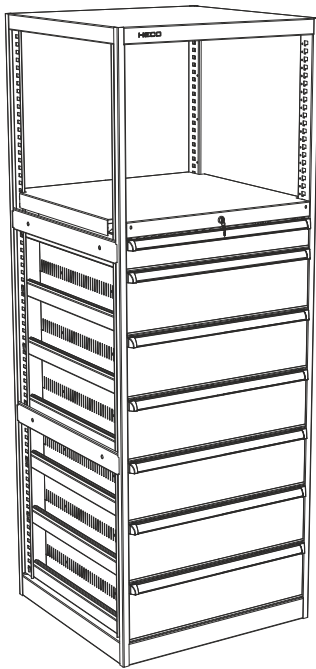

Los cajones no incluyen divisiones.  
Les tiroirs non inclus les séparations.  
Divisions non included at drawers.

SERIE 115 E 1 STANDARD



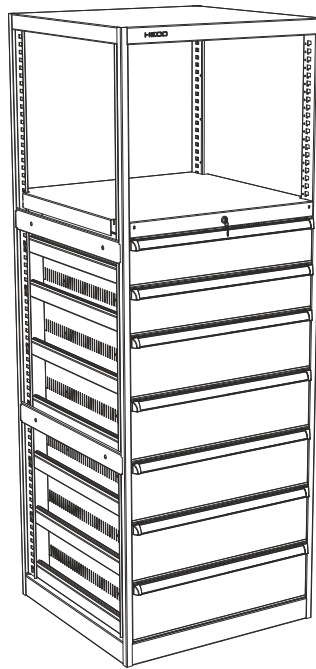

115 E 1 4 11	174,5 Kg	 	cajones/tiroirs/drawers 1x 115 C100 6x 115 C200
--------------	----------	---	---



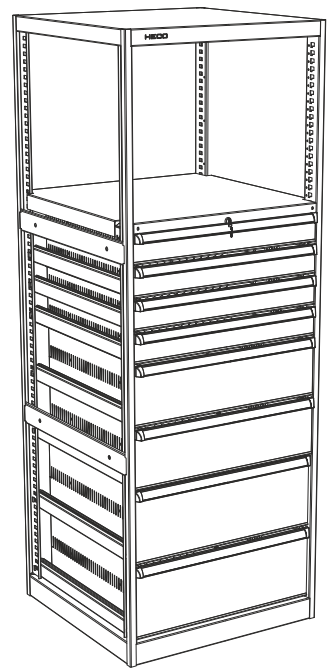

115 E 1 4 12	172,5 Kg	 	cajones/tiroirs/drawers 2x 115 C150 5x 115 C200
--------------	----------	---	---



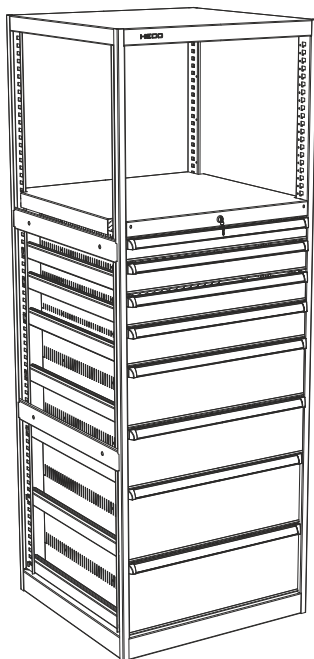

115 E 1 4 13	185 Kg	 	cajones/tiroirs/drawers 4x 115 C100 2x 115 C200 2x 115 C250
--------------	--------	---	--



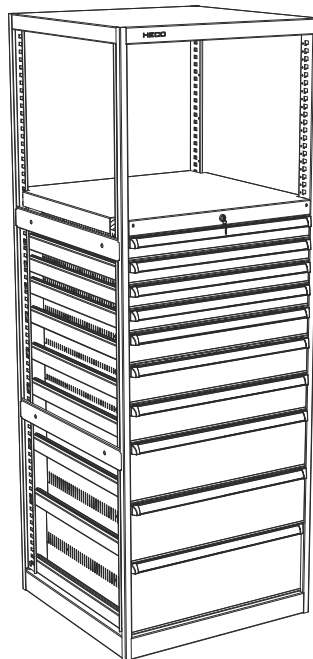

115 E 1 4 14	185 Kg	 	cajones/tiroirs/drawers 1x 115 C75 2x 115 C100 1x 115 C125 2x 115 C200 2x 115 C250
--------------	--------	---	---

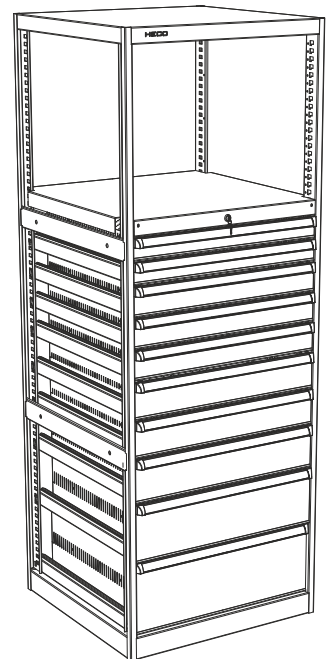

115 E 1 4 15	202 Kg	 	cajones/tiroirs/drawers 4x 115 C75 1x 115 C100 2x 115 C125 2x 115 C200 1x 115 C250
--------------	--------	---	---



115 E 1 4 16	191 Kg	 	cajones/tiroirs/drawers 2x 115 C75 3x 115 C100 2x 115 C125 1x 115 C150 1x 115 C200 1x 115 C250
--------------	--------	---	--

## SERIE 115 E 1 STANDARD

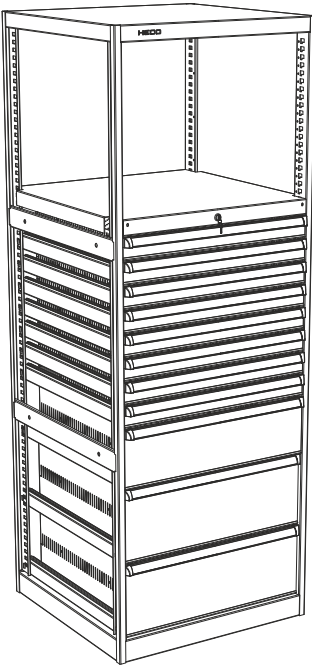

115 E 1 4 17 208,5 Kg



cajones/tiroirs/drawers

8x 115 C75  
1x 115 C200  
2x 115 C250

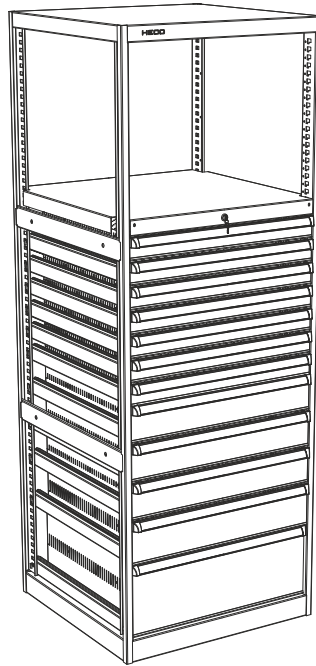

115 E 1 4 18 220 Kg



cajones/tiroirs/drawers

7x 115 C75  
3x 115 C125  
1x 115 C150  
1x 115 C250

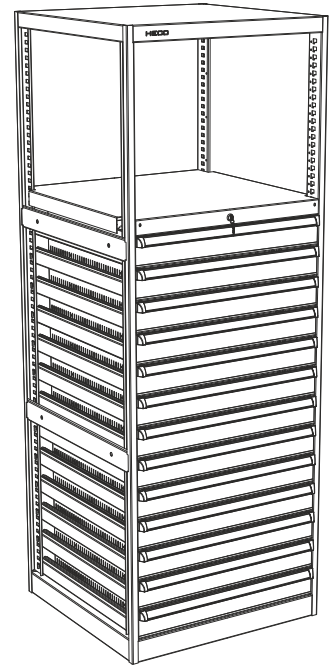

115 E 1 4 19 237 Kg



cajones/tiroirs/drawers

13x 115 C100

## SERIE 115 E 2 STANDARD

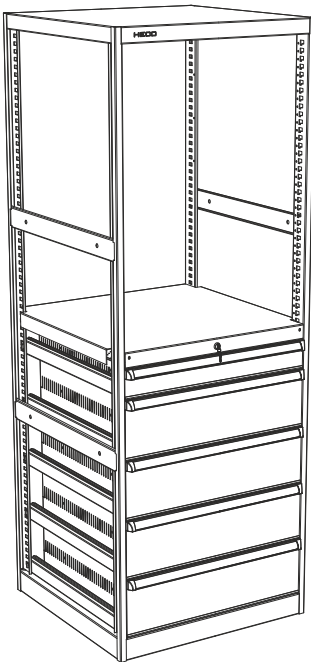

115 E 2 2 21 134 Kg



cajones/tiroirs/drawers

1x 115 C100  
4x 115 C200

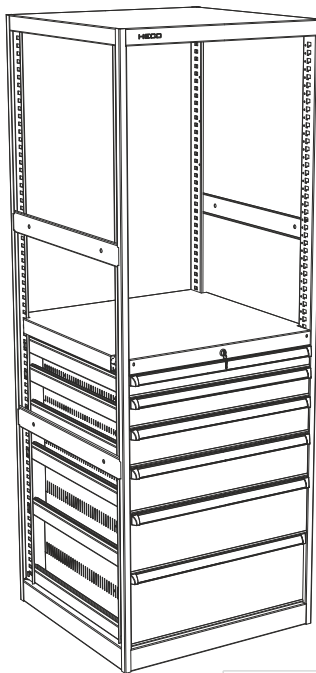

115 E 2 2 12 155 Kg



cajones/tiroirs/drawers

1x 115 C75  
1x 115 C100  
1x 115 C125  
1x 115 C150  
1x 115 C200  
1x 115 C250

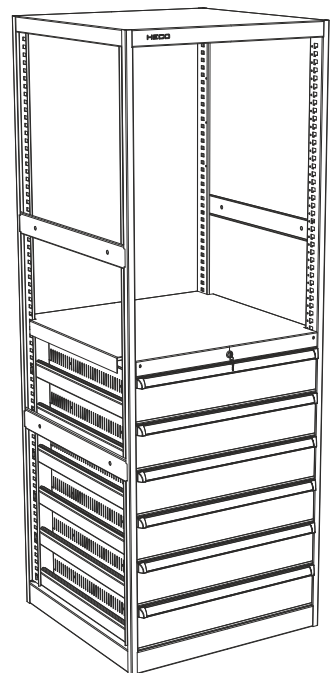

115 E 2 2 13 156 Kg





cajones/tiroirs/drawers

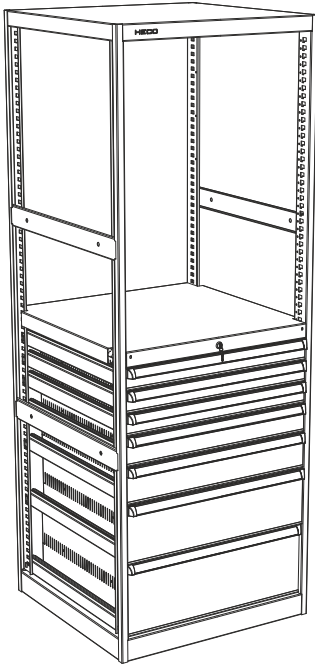

6x 115 C150

SERIE 115 E 2 STANDARD



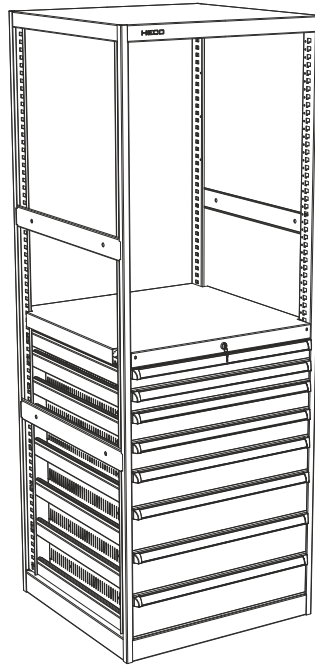

115 E 2 2 14	163,5 Kg	 	cajones/tiroirs/drawers 3x 115 C75 1x 115 C100 1x 115 C125 1x 115 C200 1x 115 C250
--------------	----------	---	---



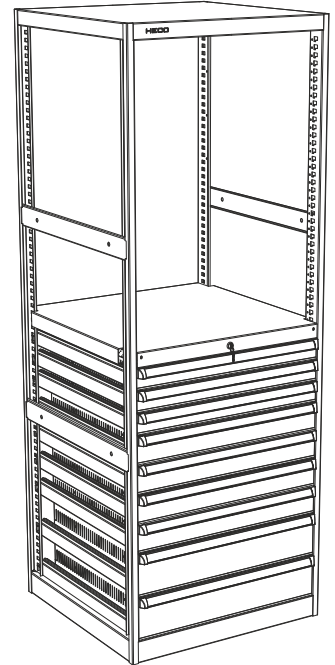

115 E 2 2 15	175 Kg	 	cajones/tiroirs/drawers 2x 115 C75 2x 115 C100 2x 115 C125 2x 115 C150
--------------	--------	---	--



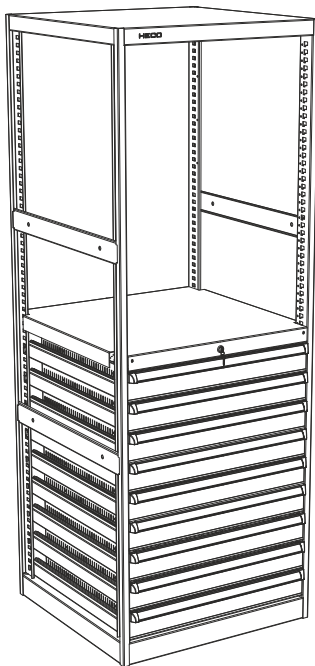

115 E 2 2 16	184,5Kg	 	cajones/tiroirs/drawers 3x 115 C75 4x 115 C100 1x 115 C125 1x 115 C150
--------------	---------	---	--



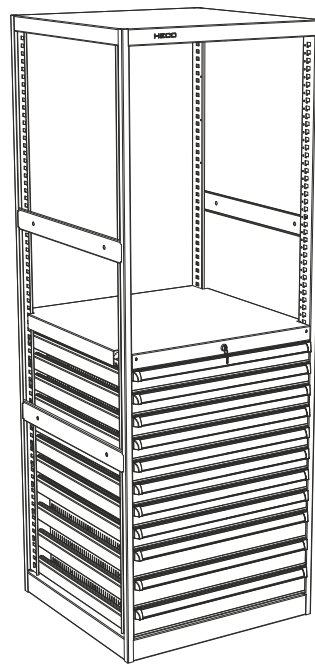

115 E 2 2 17	187,5Kg	 	cajones/tiroirs/drawers 9x 115 C100
--------------	---------	---	--

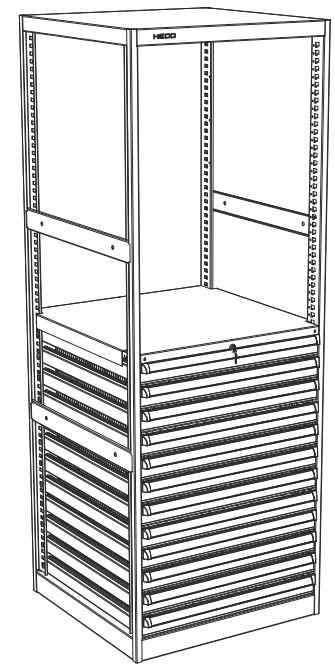

115 E 2 2 18	200,5 Kg	 	cajones/tiroirs/drawers 8x 115 C75 3x 115 C100
--------------	----------	---	--



115 E 2 2 19	207 Kg	 	cajones/tiroirs/drawers 12x 115 C75
--------------	--------	---	--

SERIE 115 E 3 STANDARD

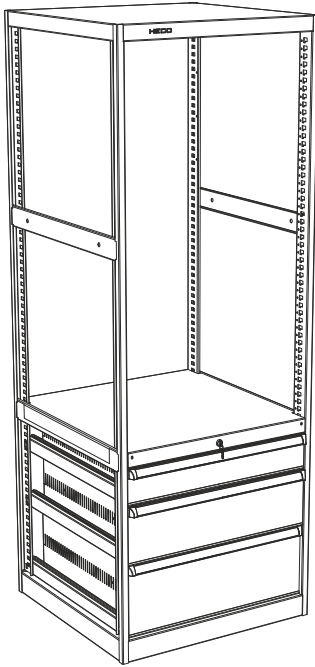

115 E 3 1 11	118 Kg		cajones/tiroirs/drawers 1x 115 C150 1x 115 C200 1x 115 C250
--------------	--------	--	--

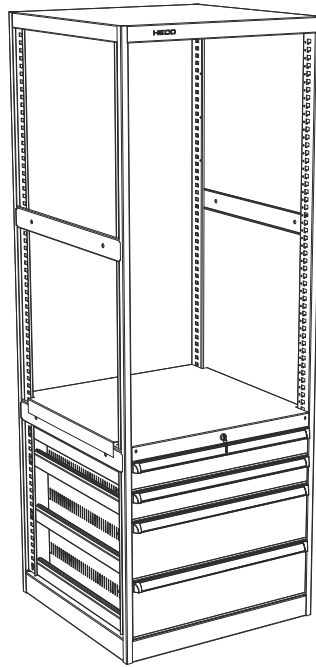

115 E 3 1 12	129 Kg		cajones/tiroirs/drawers 2x 115 C100 2x 115 C200
--------------	--------	--	---

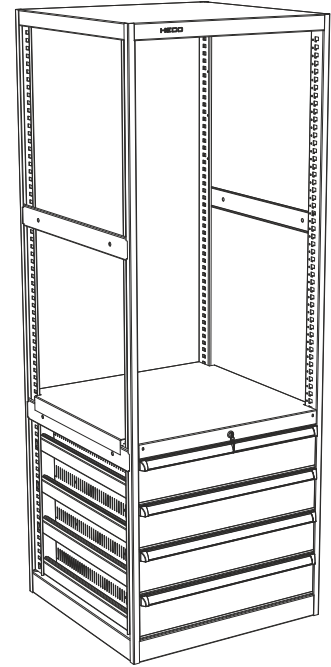

115 E 3 1 13	129 Kg		cajones/tiroirs/drawers 4x 115 C150
--------------	--------	--	--

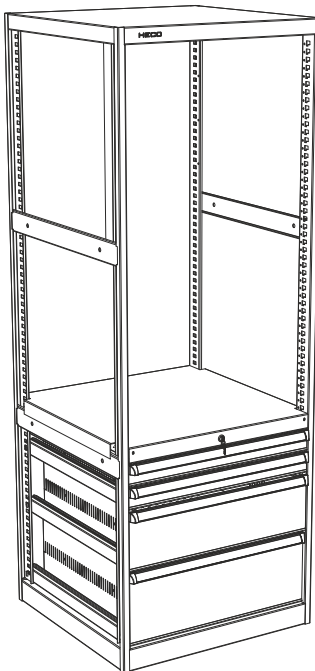

115 E 3 1 14	127 Kg		cajones/tiroirs/drawers 2x 115 C75 1x 115 C200 1x 115 C250
--------------	--------	--	---

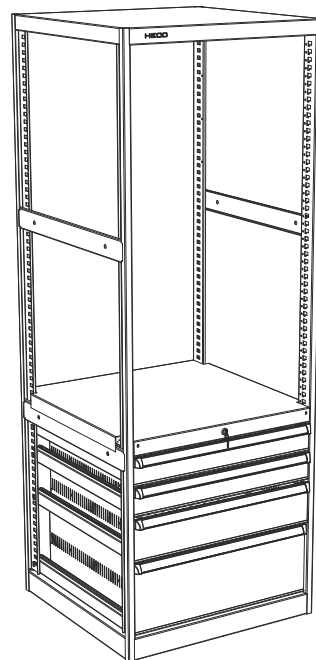

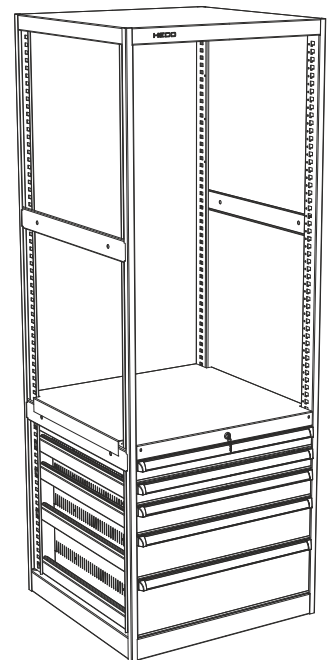

115 E 3 1 15	128 Kg		cajones/tiroirs/drawers 2x 115 C100 1x 115 C150 1x 115 C250
--------------	--------	--	--



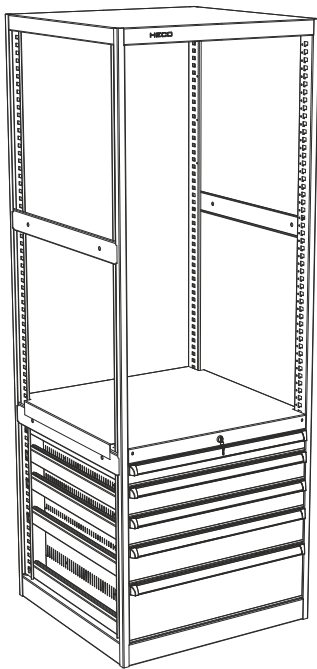

115 E 3 1 16	137,5 Kg		cajones/tiroirs/drawers 2x 115 C75 1x 115 C100 1x 115 C150 1x 115 C200
--------------	----------	--	--

SERIE 115 E 3 STANDARD

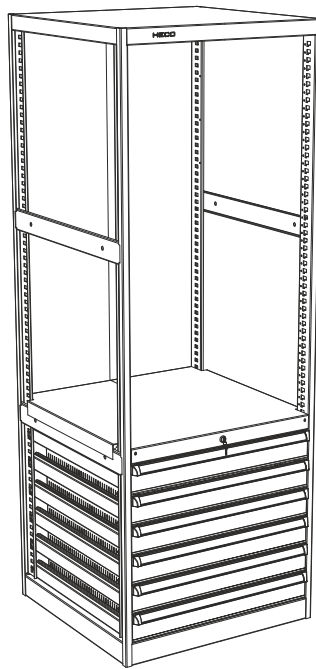

115 E 3 1 17	138,5 Kg	 	cajones/tiroirs/drawers 1x 115 C75 2x 115 C100 1x 115 C125 1x 115 C200
--------------	----------	---	--



115 E 3 1 18	150 Kg	 	cajones/tiroirs/drawers 6x 115 C100
--------------	--------	---	--

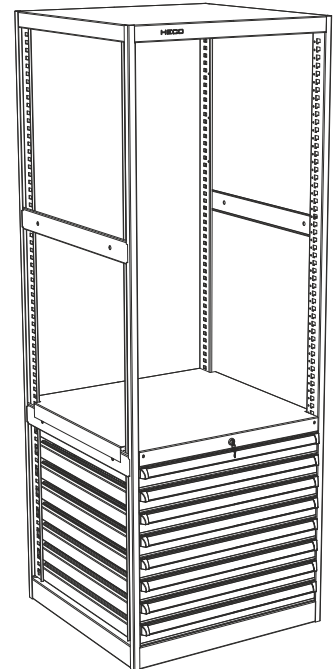

115 E 3 1 19	141 Kg	 	cajones/tiroirs/drawers 8x 115 C75
--------------	--------	---	---------------------------------------

SERIE 115 E COMPONENTES / COMPOSANTS / COMPONENTS

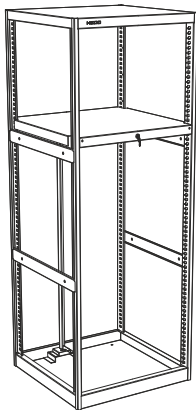

115 E 1 MC	75 Kg	LxAxH (mm) 717x710x2000
------------	-------	----------------------------

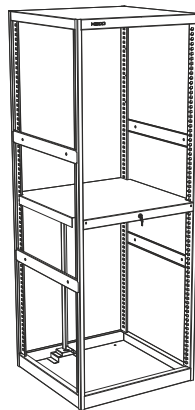

115 E 2 MC	75 Kg	LxAxH (mm) 717x710x2000
------------	-------	----------------------------

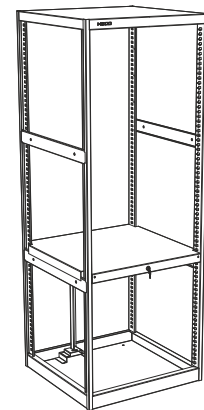

115 E 3 MC	75 Kg	LxAxH (mm) 717x710x2000
------------	-------	----------------------------

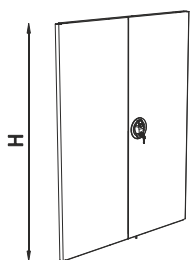

		H (mm)
115 E 1 P	5,5 Kg	535
115 E 2 P	7,3 Kg	935
115 E 3 P	8,6 Kg	1235
115 E P	9,9 Kg	1915

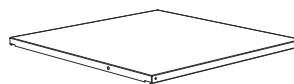

115 EG	8 Kg	descripción/description/description estantería graduable étagère réglable adjustable shelf
--------	------	---

Soportes incluidos / Supports inclus / Included supports

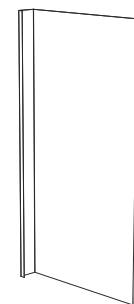

115 E L	13 Kg	LxH (mm) 730x2000
---------	-------	----------------------

lateral / latéral / lateral



**SERIE 119 E** ref. 119 E 1 / 119 E 2 / 119 E 3

Armarios con cajones y estanterías.  
Armoires avec tiroirs et étagères.  
Cabinets with drawers and shelves.

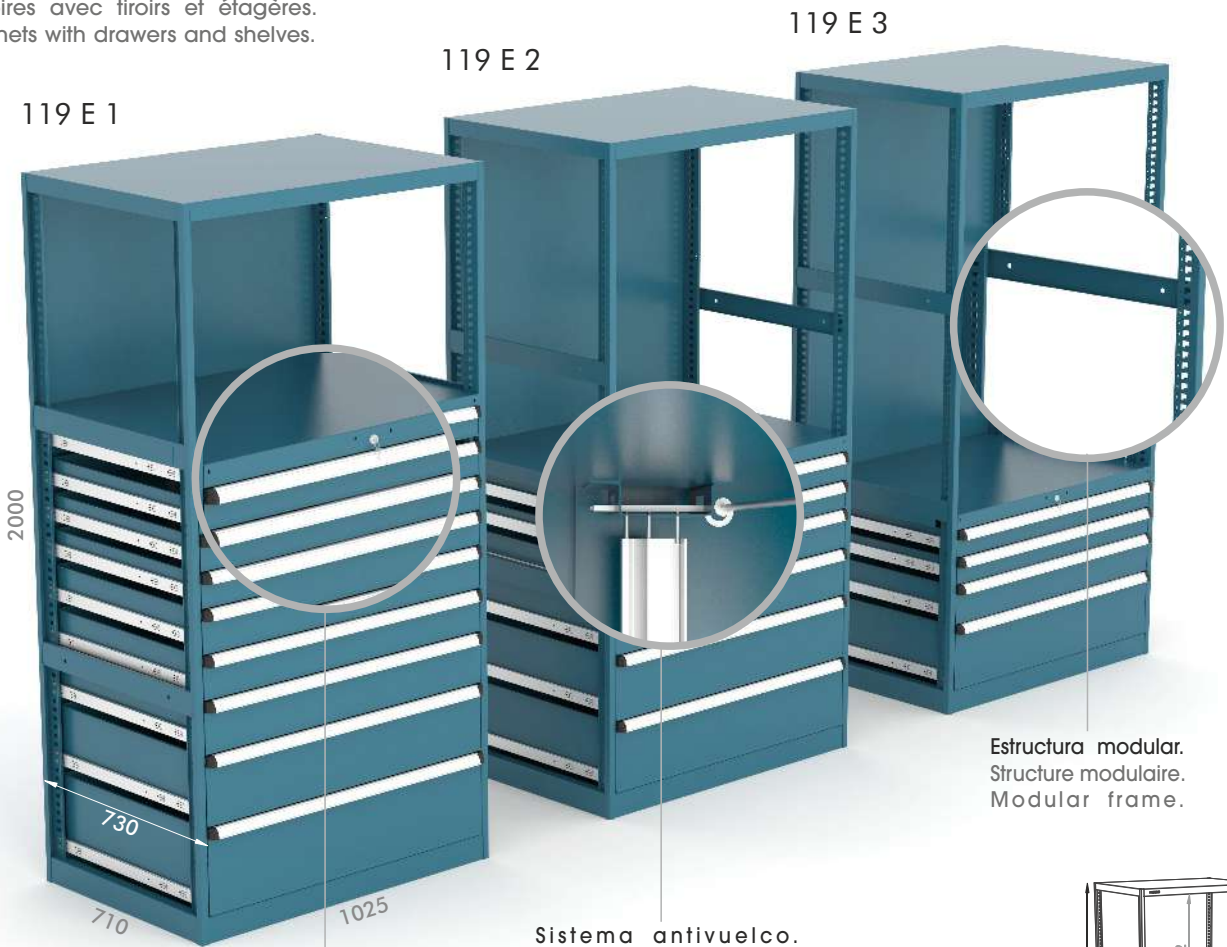

Cierre centralizado.  
Verrouillage centralisé.  
Central locking.

Sistema antivuelco.  
Système anti-renversement.  
Anti-roll system.

Estructura modular.  
Structure modulaire.  
Modular frame.

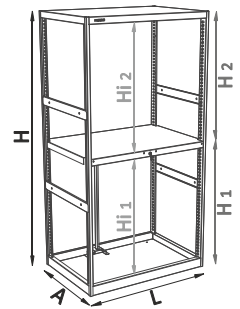

	LxAxH (mm)	H1 (mm)	H2 (mm)	Hi 1 (mm)	Hi 2 (mm)
119 E 1	1025x710x2000	1435	600	1300	550
119 E 2	1025x710x2000	1035	1000	900	950
119 E 3	1025x710x2000	735	1300	600	1250

**e** 1 mm

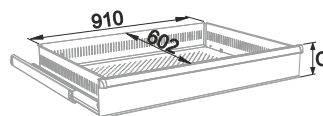

		GT	100	
SERIE 119	C=50	●	●	119 T50 C75 15,5Kg
	C=75	●	●	119 T50 C100 16,5Kg
	C=100	●	●	119 T50 C125 17,5Kg
	C=125	●	●	119 T50 C150 18,5Kg
	C=150	●	●	119 T50 C200 19Kg
	C=200	●	●	119 T50 C250 20Kg
	C=250	●	●	119 T50 C250 22,5Kg
C=300				
		<b>e</b>		1.5 mm



Plazo de entrega 10 días laborables.  
Délai de livraison 10 jours ouvrables.  
Delivery time 10 working days.





Para más información de cajones, ver PAG. 45.  
Pour plus d'information de tiroirs, voir PAGE. 45.  
For further information of drawers, see PAGE. 45.



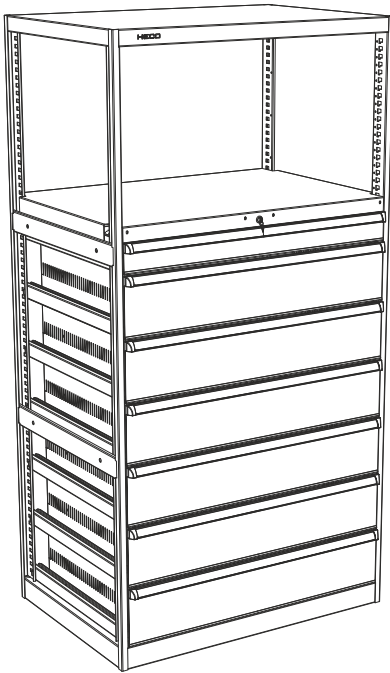

Los cajones no incluyen divisiones.  
Les tiroirs non inclus les séparations.  
Divisions non included at drawers.

SERIE 119 E 1 STANDARD



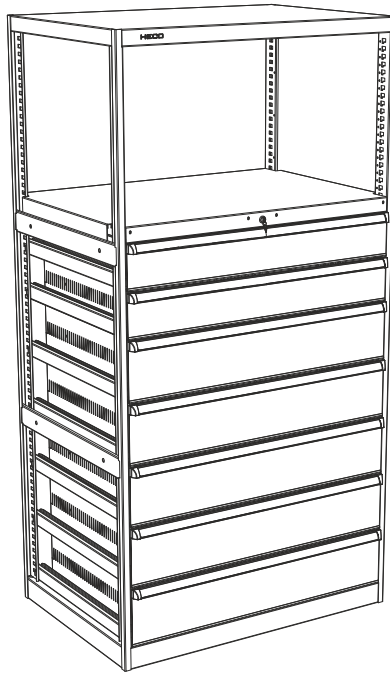

		cajones/tiroirs/drawers	
119 E 1 4 11	249,5 Kg	 	1x 119 C100 6x 119 C200



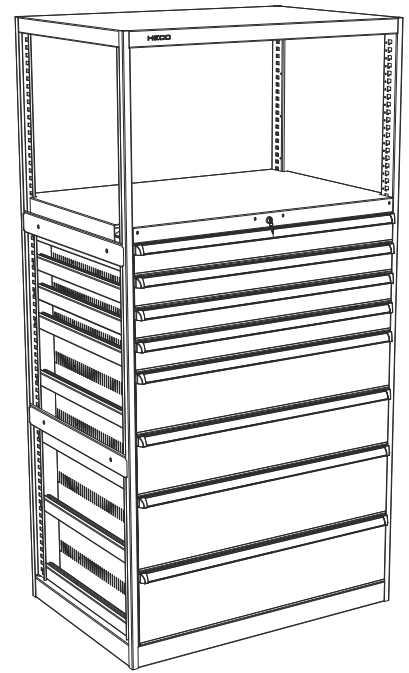

		cajones/tiroirs/drawers	
119 E 1 4 12	295 Kg	 	2x 119 C150 5x 119 C200



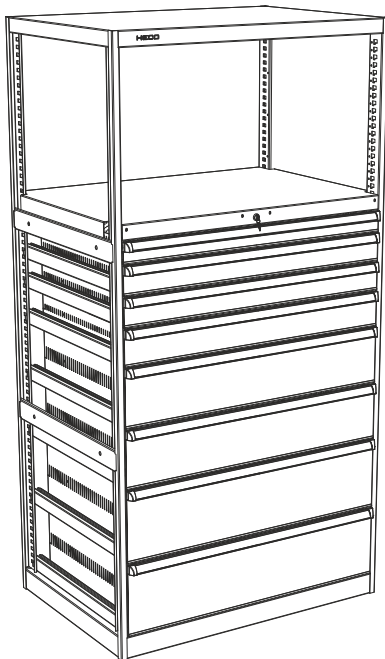

		cajones/tiroirs/drawers	
119 E 1 4 13	262 Kg	 	4x 119 C100 2x 119 C200 2x 119 C250



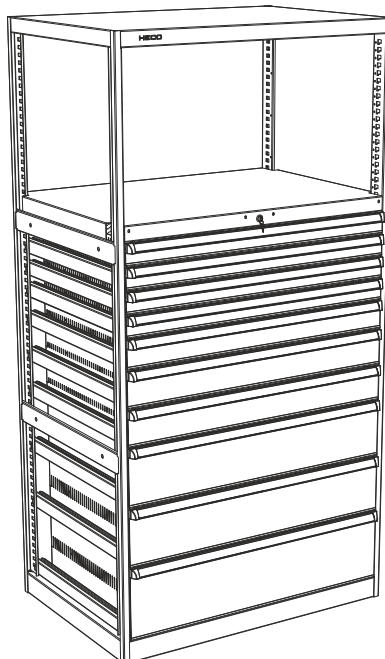

		cajones/tiroirs/drawers	
119 E 1 4 14	267 Kg	 	1x 119 C75 2x 119 C100 1x 119 C125 2x 119 C200 2x 119 C250

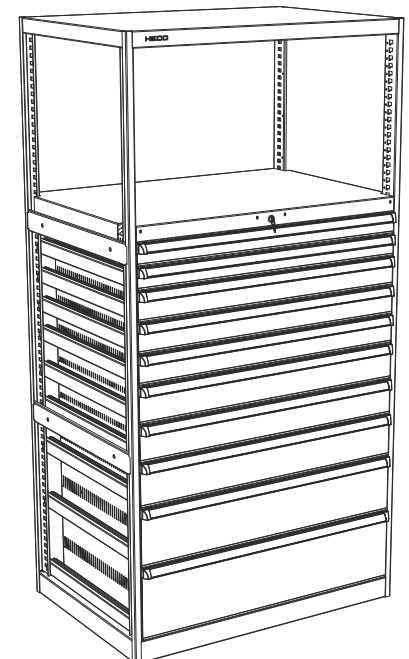

		cajones/tiroirs/drawers	
119 E 1 4 15	295 Kg	 	4x 119 C75 1x 119 C100 2x 119 C125 2x 119 C200 1x 119 C250



		cajones/tiroirs/drawers	
119 E 1 4 16	278,5 Kg	 	2x 119 C75 3x 119 C100 2x 119 C125 1x 119 C150 1x 119 C200 1x 119 C250

## SERIE 119 E 1 STANDARD

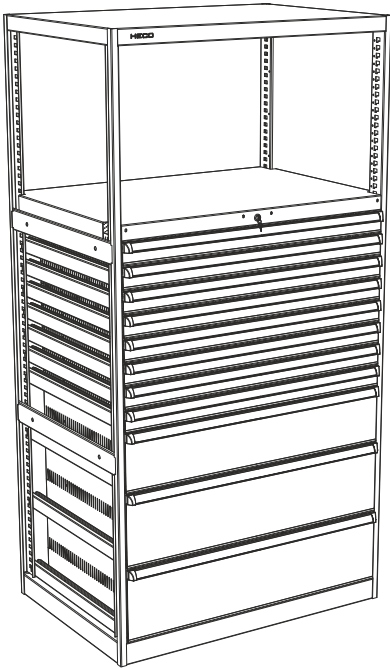

119 E 1 4 17	309 Kg		cajones/tiroirs/drawers 8x 119 C75 1x 119 C200 2x 119 C250
--------------	--------	--	---

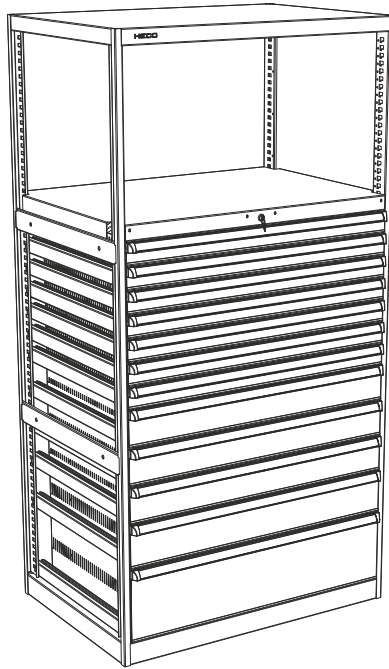

119 E 1 4 18	324,5 Kg		cajones/tiroirs/drawers 7x 119 C75 3x 119 C125 1x 119 C150 1x 119 C250
--------------	----------	--	--

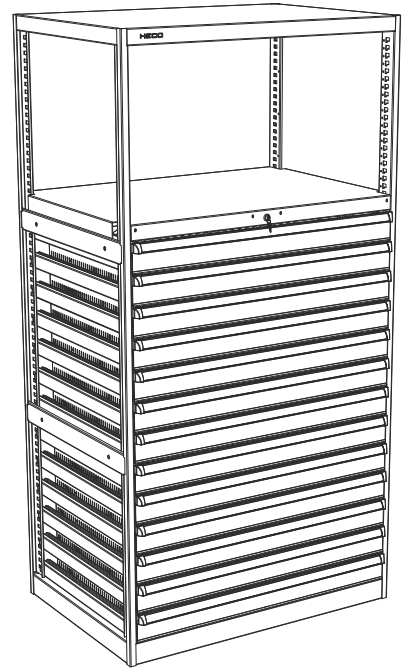

119 E 1 4 19	339,5 Kg		cajones/tiroirs/drawers 13x 119 C100
--------------	----------	--	---

## SERIE 119 E 2 STANDARD

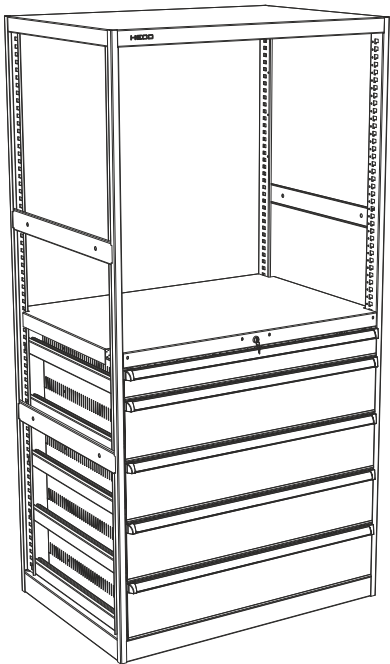

119 E 2 2 11	215 Kg		cajones/tiroirs/drawers 1x 119 C100 4x 119 C200
--------------	--------	--	---

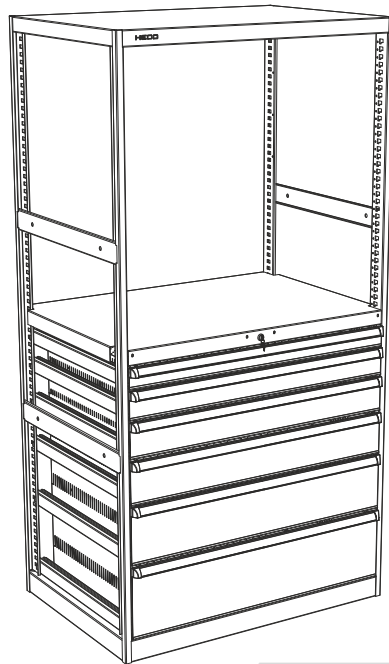

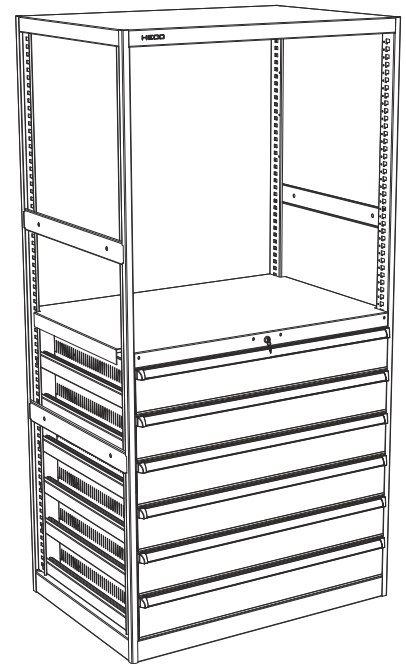

119 E 2 2 12	226 Kg		cajones/tiroirs/drawers 1x 119 C75 1x 119 C100 1x 119 C125 1x 119 C150 1x 119 C200 1x 119 C250
--------------	--------	--	--



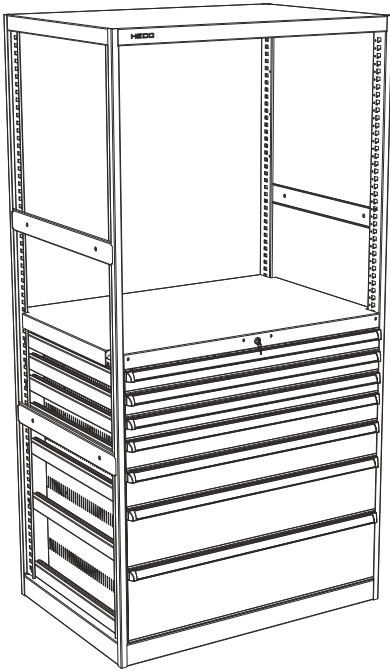

119 E 2 2 13	226 Kg		cajones/tiroirs/drawers 6x 119 C150
--------------	--------	--	--

SERIE 119 E 2 STANDARD



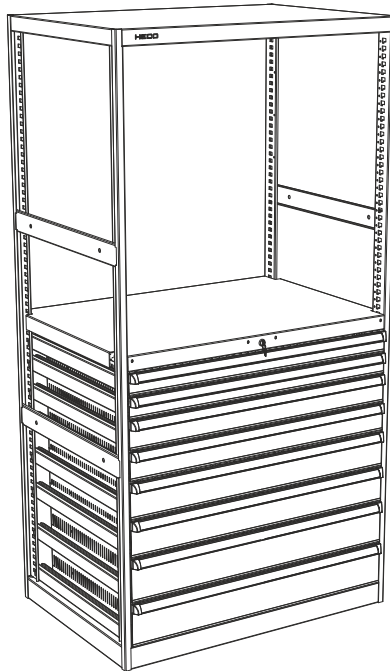

119 E 2 2 14	240 Kg	 	cajones/tiroirs/drawers
			3x 119 C75 1x 119 C100 1x 119 C125 1x 119 C200 1x 119 C250



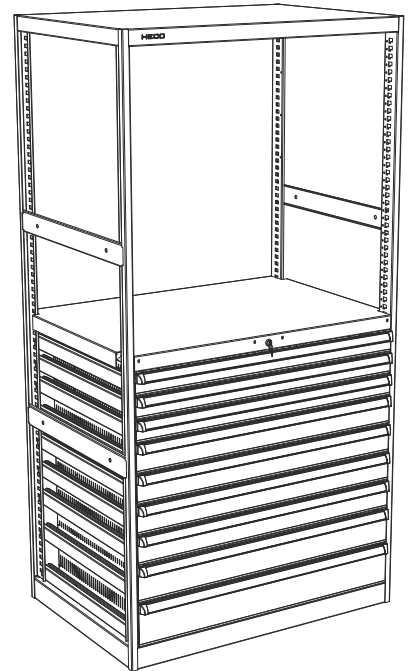

119 E 2 2 15	255 Kg	 	cajones/tiroirs/drawers
			2x 119 C75 2x 119 C100 2x 119 C125 2x 119 C150



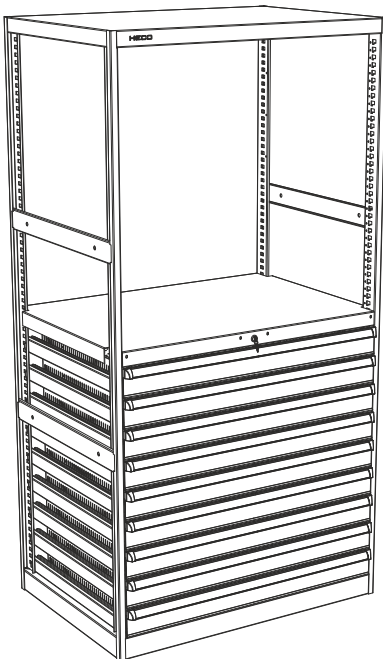

110 E 2 2 16	269Kg	 	cajones/tiroirs/drawers
			3x 119 C75 4x 119 C100 1x 119 C125 1x 119 C150



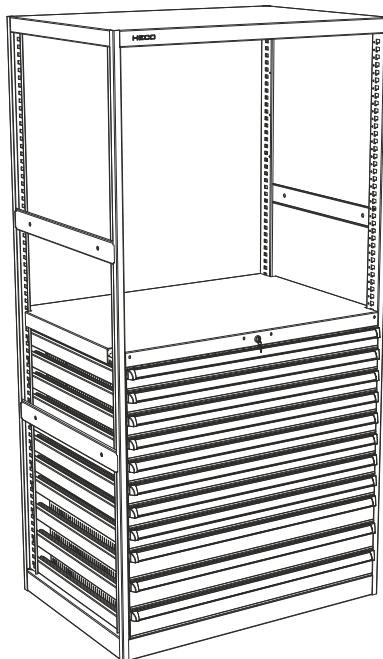

119 E 2 2 17	269,5Kg	 	cajones/tiroirs/drawers
			9x 119 C100

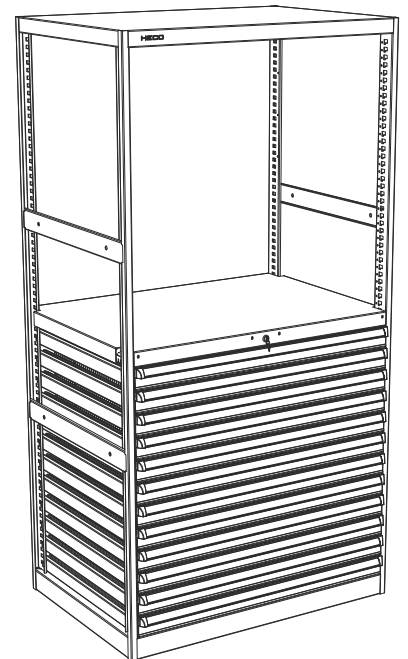

119 E 2 2 18	296,5 Kg	 	cajones/tiroirs/drawers
			8x 119 C75 3x 119 C100



119 E 2 2 19	310 Kg	 	cajones/tiroirs/drawers
			12x 119 C75

SERIE 119 E 3 STANDARD

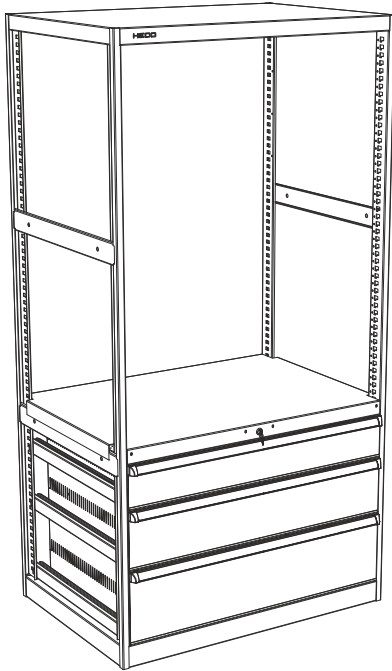

119 E 3 1 11	173,5 Kg			cajones/tiroirs/drawers 1x 119 C150 1x 119 C200 1x 119 C250
--------------	----------	--	--	--

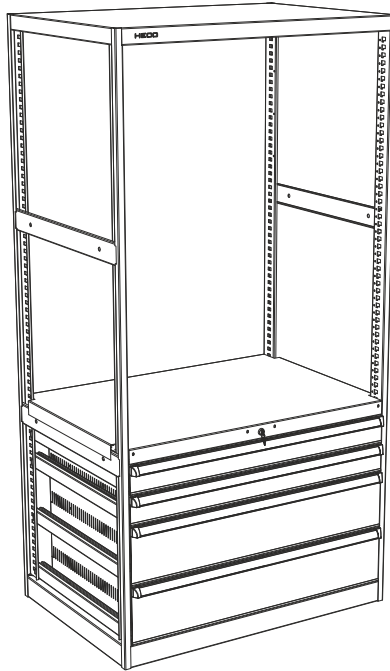

119 E 3 1 12	187 Kg			cajones/tiroirs/drawers 2x 119 C100 2x 119 C200
--------------	--------	--	--	---

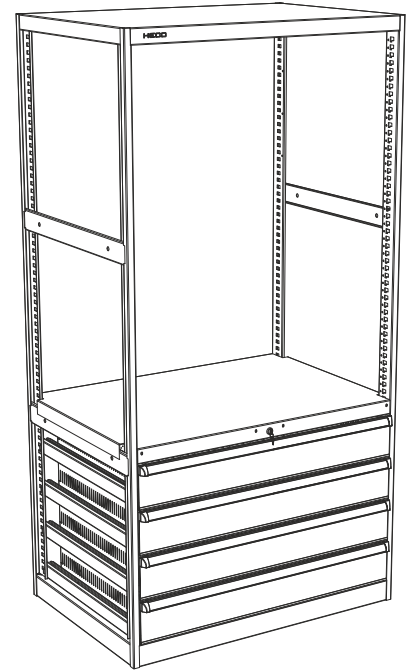

119 E 3 1 13	188 Kg			cajones/tiroirs/drawers 4x 119 C150
--------------	--------	--	--	--

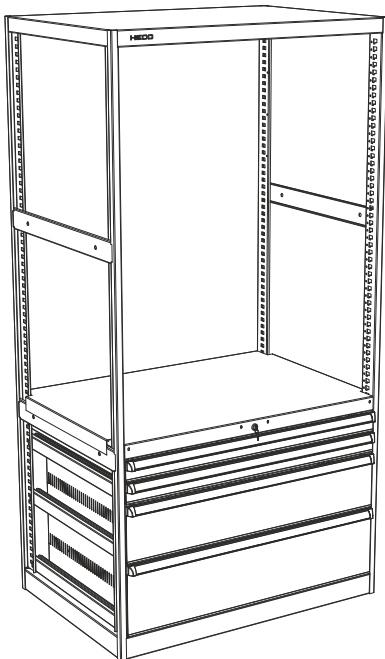

119 E 3 1 14	187,5 Kg			cajones/tiroirs/drawers 2x 119 C75 1x 119 C200 1x 119 C250
--------------	----------	--	--	---

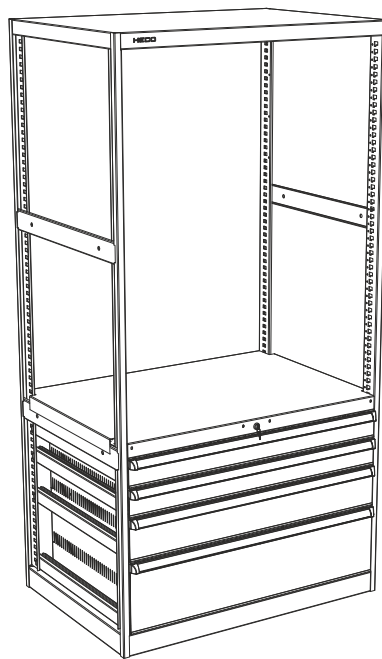

119 E 3 1 15	188,5 Kg			cajones/tiroirs/drawers 2x 119 C100 1x 119 C150 1x 119 C250
--------------	----------	--	--	--

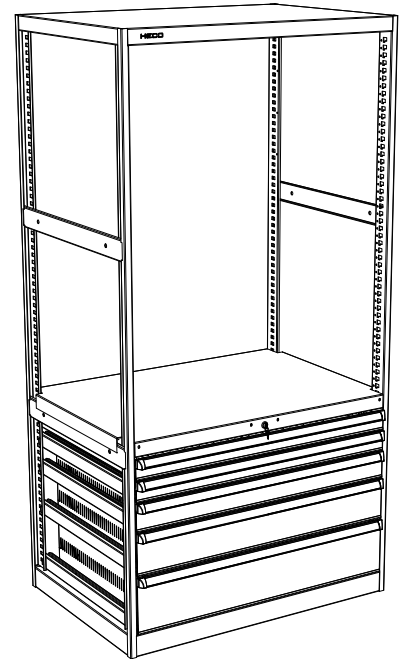

119 E 3 1 16	201 Kg			cajones/tiroirs/drawers 2x 119 C75 1x 119 C100 1x 119 C150 1x 119 C200
--------------	--------	--	--	--

SERIE 119 E 3 STANDARD

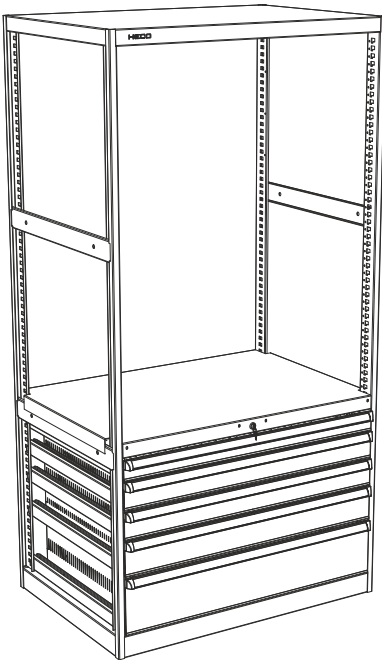

119 E 3 1 17	202 Kg		cajones/tiroirs/drawers	
			1x 119 C75 2x 119 C100 1x 119 C125 1x 119 C200	

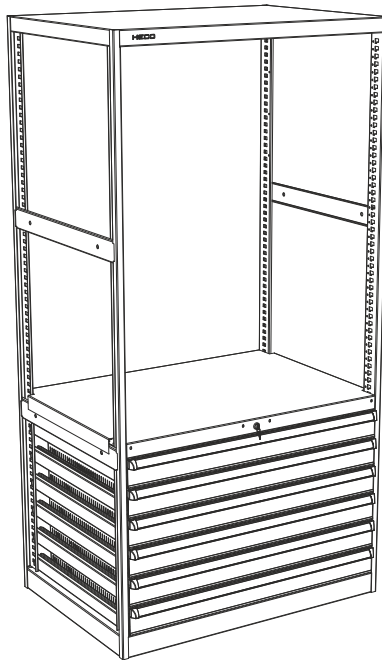

119 E 3 1 18	217 Kg		cajones/tiroirs/drawers	
			6x 119 C100	

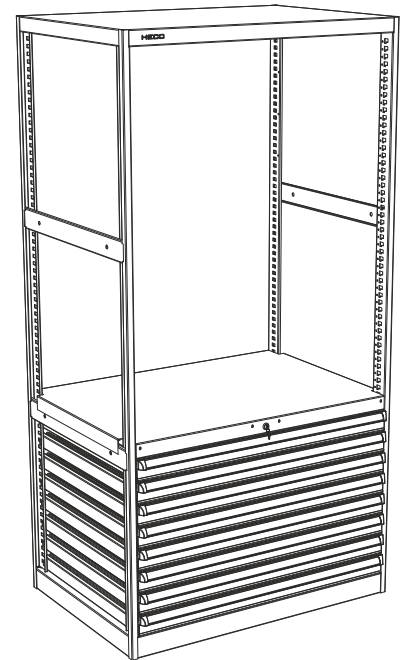

119 E 3 1 19	244 Kg		cajones/tiroirs/drawers	
			8x 119 C75	

SERIE 119 E COMPONENTES / COMPOSANTS / COMPONENTS

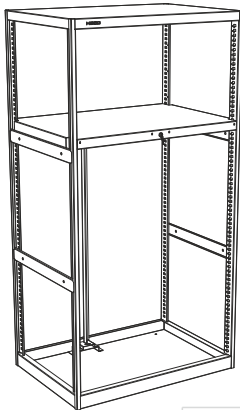

119 E 1 MC	112 Kg	LxAxH (mm)	
		1025x710x2000	

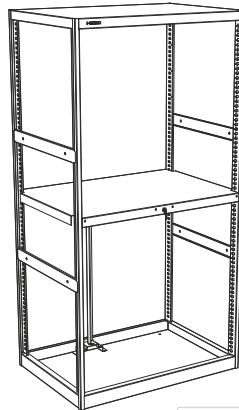

119 E 2 MC	112 Kg	LxAxH (mm)	
		1025x710x2000	

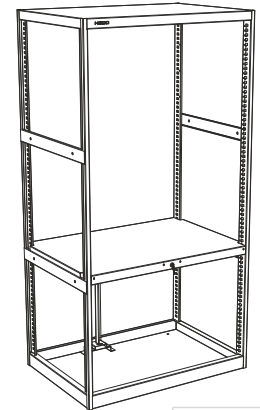

119 E 3 MC	112 Kg	LxAxH (mm)	
		1025x710x2000	

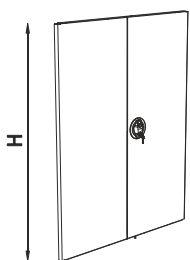

		H (mm)
119 E 1 P 1	8,4 Kg	535
119 E 2 P 2	10,7 Kg	935
119 E 3 P 3	12,5 Kg	1235
119 E P	14,3 Kg	1915

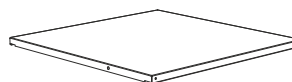

119 EG	10 Kg	descripción/description/description	
		estantería graduable étagère réglable adjustable shelf	

Soportes incluidos / Supports inclus / Included supports

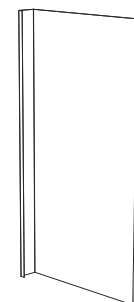

115 E L	13 Kg	LxH (mm)	
		730x2000	

lateral / latéral / lateral

## SERIE 119 E P C

Armarios con cajones y estanterías (cierre con persiana).  
Armoires avec tiroirs et étagères (fermeture avec rideau).  
Cabinets with drawers and shelves (shutter closing).

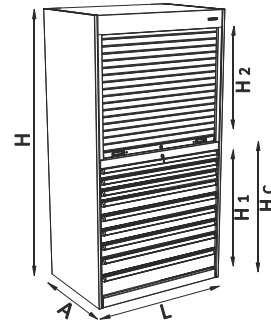

	LxAxH (mm)	H1 (mm)	H2 (mm)	Hc (mm)
119 E P C	1030x710x2000	900	785	1045

**e** 1 mm

LxAxH (mm)		
119 E P C	160 Kg	1030x710x2000

descripción/description/description		
119 EGP	10 Kg	estantería graduable étagère réglable adjustable shelf

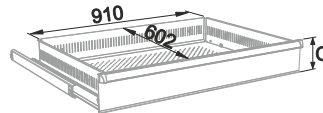

Plazo de entrega 10 días laborables.  
Délai de livraison 10 jours ouvrables.  
Delivery time 10 working days.



Para más información de cajones, ver PAG. 45.  
Pour plus d'information de tiroirs, voir PAGE. 45.  
For further information of drawers, see PAGE. 45.



Los cajones no incluyen divisiones.  
Le tiroirs non inclus les séparations.  
Divisions not included at drawers.

		GT 100	
SERIE 119	C=50	●	119 T50 C75 15,5Kg
	C=75	●	119 T50 C100 16,5Kg
	C=100	●	119 T50 C125 17,5Kg
	C=125	●	119 T50 C150 18,5Kg
	C=150	●	119 T50 C200 19Kg
	C=200	●	119 T50 C250 20Kg
C=250	●	119 T50 C250 22,5Kg	
C=300			
		<b>e</b> 1.5 mm	

## SERIE 119 E P C 2 STANDARD

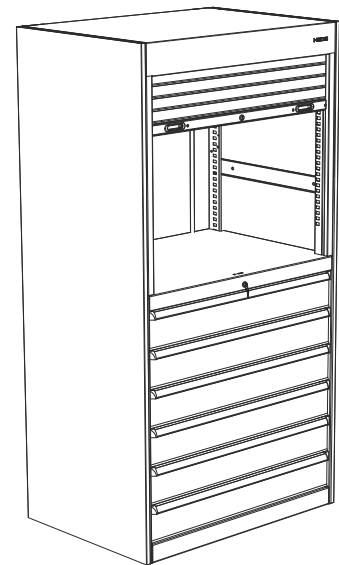
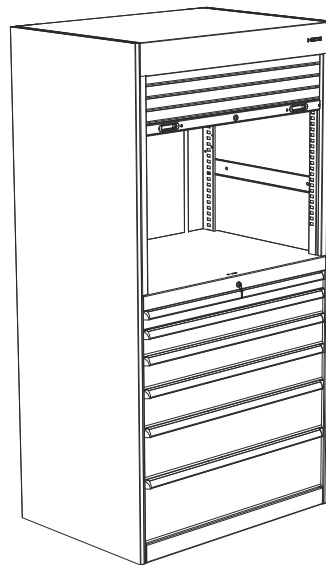
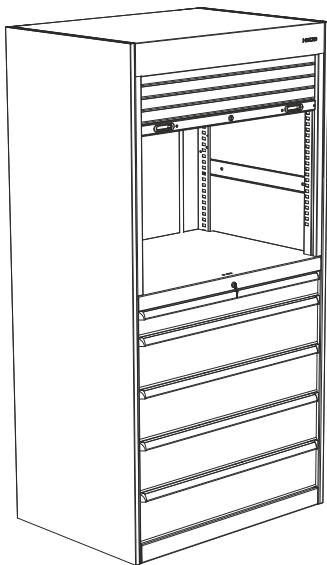



cajones/tiroirs/drawers		
119 E P C 2 11	251 Kg	1x 119 C100 4x 119 C200

cajones/tiroirs/drawers		
119 E P C 2 12	262 Kg	1x 119 C75 1x 119 C100 1x 119 C125 1x 119 C150 1x 119 C200 1x 119 C250

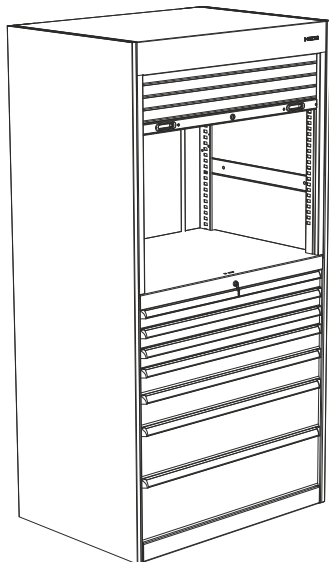

cajones/tiroirs/drawers		
119 E P C 2 13	262 Kg	6x 119 C150

SERIE 119 E P C 2 STANDARD



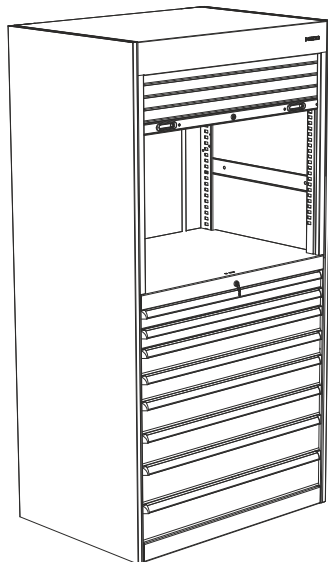

119 E P C 2 14	276 Kg	 	cajones/tiroirs/drawers
			3x 119 C75 1x 119 C100 1x 119 C125 1x 119 C200 1x 119 C250

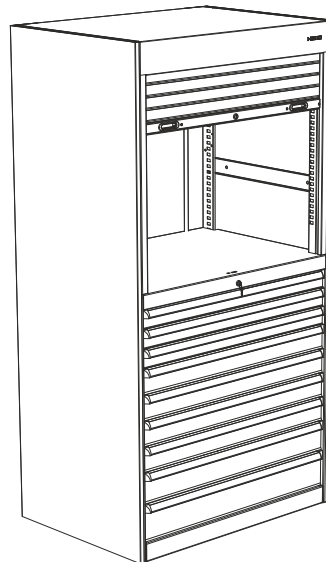

119 E P C 2 15	291 Kg	 	cajones/tiroirs/drawers
			2x 119 C75 2x 119 C100 2x 119 C125 2x 119 C150



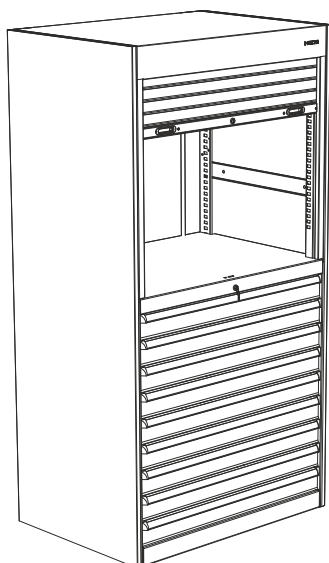

110 E P C 2 16	305Kg	 	cajones/tiroirs/drawers
			3x 119 C75 4x 119 C100 1x 119 C125 1x 119 C150



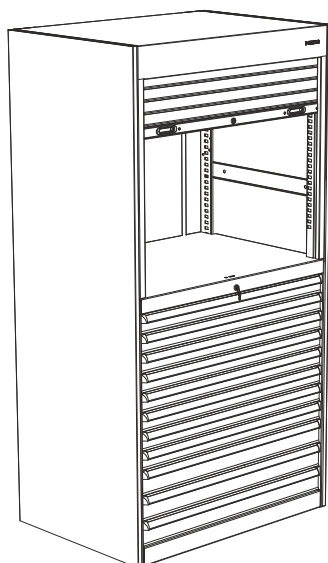

119 E P C 2 17	305,5Kg	 	cajones/tiroirs/drawers
			9x 119 C100

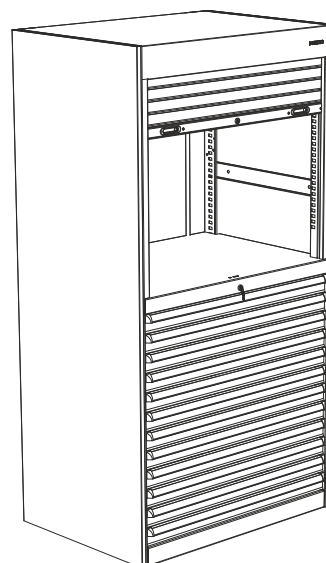

119 E P C 2 18	305,5 Kg	 	cajones/tiroirs/drawers
			8x 119 C75 3x 119 C100



119 E P C 2 19	346 Kg	 	cajones/tiroirs/drawers
			12x 119 C75



## SERIE 127 ref. 127 3 / 127 4 / 127 5 / 127 6

Armario con puertas y cajones.  
Armoire avec portes et tiroirs.  
Cabinets with doors and drawers.



Sistema antivuelco.  
Système anti-renversement.  
Roll-over protection system.



Cierre centralizado.  
Verrouillage centralisé.  
Central locking.

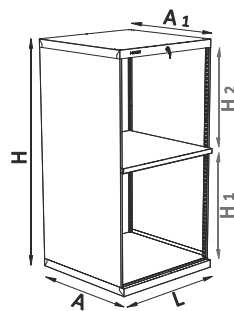
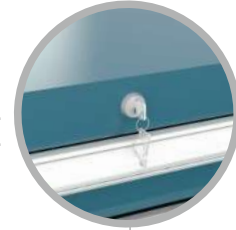

	Lx(AxA1)xH (mm)	H1 (mm)	H2 (mm)
127 3	714x(730x707)x1000	600	275
127 4	714x(730x707)x1400	900	375
127 5	714x(730x707)x1400	675	600
127 6	714x(730x707)x1400	600	675

**e** 1 mm

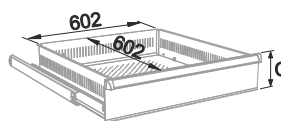

		GT	100	
SERIE 115	C=50	●	115 T100 C50	10,5Kg
	C=75	●	115 T100 C75	11Kg
	C=100	●	115 T100 C100	12,5Kg
	C=125	●	115 T100 C125	13Kg
	C=150	●	115 T100 C150	13,5Kg
	C=200	●	115 T100 C200	14,5Kg
	C=250	●	115 T100 C250	15,5Kg
C=300				
		<b>e</b>	1.5 mm	



Plazo de entrega 10 días laborables.  
Délai de livraison 10 jours ouvrables.  
Delivery time 10 working days.



Para más información de cajones, ver PAG. 45.  
Pour plus d'information de tiroirs, voir PAGE. 45.  
For further information of drawers, see PAGE. 45.



Los cajones no incluyen divisiones.  
Le tiroirs non inclus les séparations.  
Divisions non included at drawers.

SERIE 127 3 STANDARD

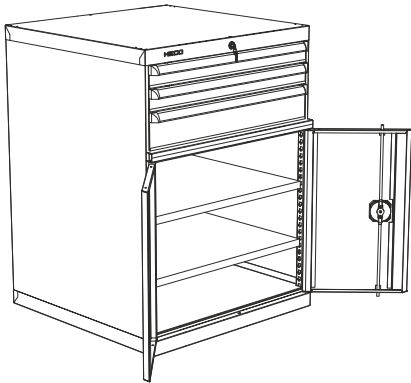

		L x A x H (mm)
127 3 1	77,5 Kg	714x730x1000
cajones/tiroirs/drawers	armario/armoire/cabinet	
	2x 115 C75 1x 115 C125	2x 127 BG estantería graduable étagère réglable adjustable shelf

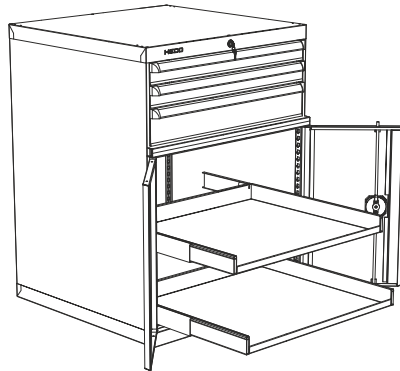

		L x A x H (mm)
127 3 2	97,5 Kg	714x730x1000
cajones/tiroirs/drawers	armario/armoire/cabinet	
	2x 115 C75 1x 115 C125	2x 127 BE T100 bandeja extraíble plateau amovible tray removable

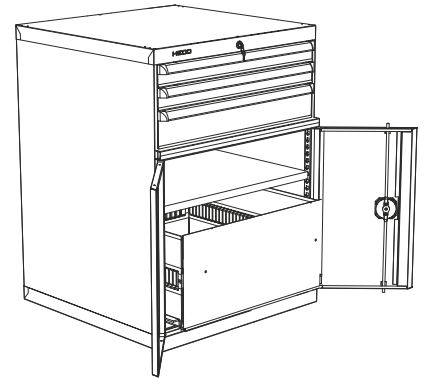

		L x A x H (mm)
127 3 3	104 Kg	714x730x1000
cajones/tiroirs/drawers	armario/armoire/cabinet	
	2x 115 C75 1x 115 C125	127 BG estantería graduable étagère réglable adjustable shelf
		127 T100 300 cajón H:300 mm tiroir H:300mm drawer H:300mm

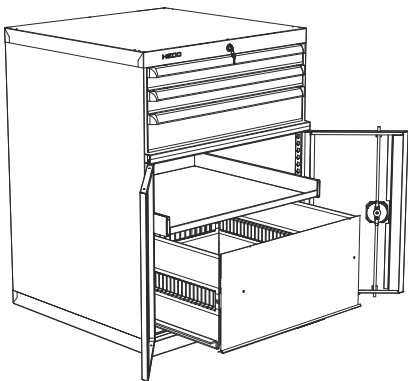

		L x A x H (mm)
127 3 4	112,5 Kg	714x730x1000
cajones/tiroirs/drawers	armario/armoire/cabinet	
	2x 115 C75 1x 115 C125	127 BE T100 bandeja extraíble plateau amovible tray removable
		127 T100 300 cajón H:300 mm tiroir H:300mm drawer H:300mm

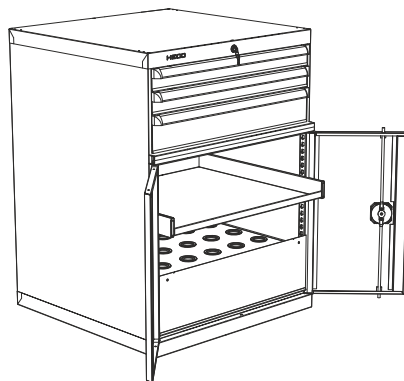

		L x A x H (mm)
127 3 5	110,5 Kg	714x730x1000
cajones/tiroirs/drawers	armario/armoire/cabinet	
	2x 115 C75 1x 115 C125	127 BE T100 bandeja extraíble plateau amovible tray removable
		127 T200 40 cajón porta conos tiroir porte-cônes tool-holder drawer

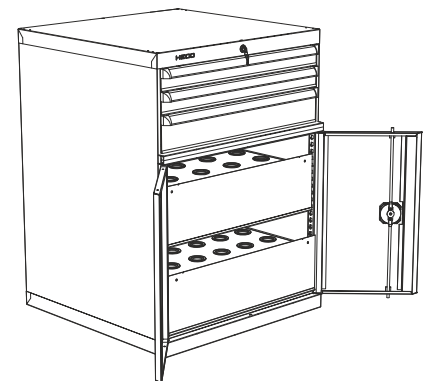

		L x A x H (mm)
127 3 6	123,5 Kg	714x730x1000
cajones/tiroirs/drawers	armario/armoire/cabinet	
	2x 115 C75 1x 115 C125	127 T200 40 cajón porta conos tiroir porte-cônes tool-holder drawer
		127 T200 50 cajón porta conos tiroir porte-cônes tool-holder drawer

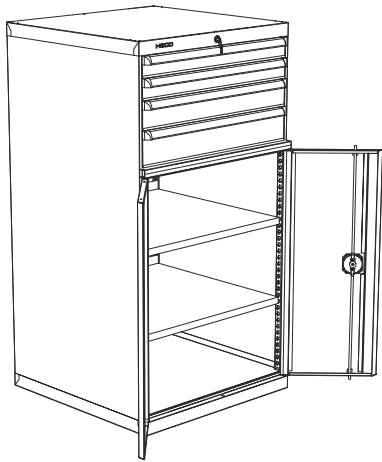
**SERIE 127 4 STANDARD**

		<b>L x A x H (mm)</b>
<b>127 4 1</b>	97,5 Kg	714x730x1400
<b>cajones/tiroirs/drawers</b>	<b>armario/armoire/cabinet</b>	
 2x 115 C75 1x 115 C100 1x 115 C125	2x 127 BG estanteria graduable étagère réglable adjustable shelf	

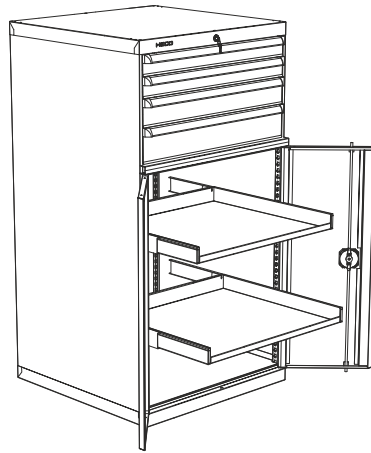

		<b>L x A x H (mm)</b>
<b>127 4 2</b>	114,5 Kg	714x730x1400
<b>cajones/tiroirs/drawers</b>	<b>armario/armoire/cabinet</b>	
 2x 115 C75 1x 115 C100 1x 115 C125	2x 127 BE T100 bandeja extraíble plateau amovible tray removable	

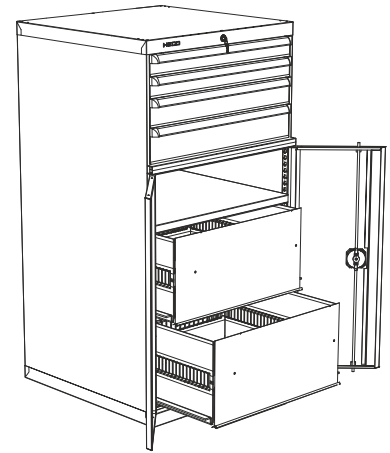

		<b>L x A x H (mm)</b>
<b>127 4 3</b>	146 Kg	714x730x1400
<b>cajones/tiroirs/drawers</b>	<b>armario/armoire/cabinet</b>	
 2x 115 C75 1x 115 C100 1x 115 C125	127 BG estanteria graduable étagère réglable adjustable shelf  2x 127 T100 300 cajón H:300 mm tiroir H:300mm drawer H:300mm 	

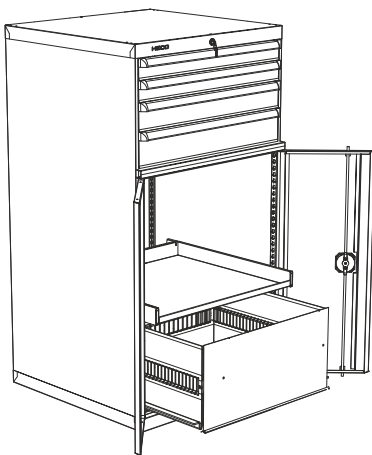

		<b>L x A x H (mm)</b>
<b>127 4 4</b>	129,5 Kg	714x730x1400
<b>cajones/tiroirs/drawers</b>	<b>armario/armoire/cabinet</b>	
 2x 115 C75 1x 115 C100 1x 115 C125	127 BE T100 bandeja extraíble plateau amovible tray removable  127 T100 300 cajón H:300 mm tiroir H:300mm drawer H:300mm 	

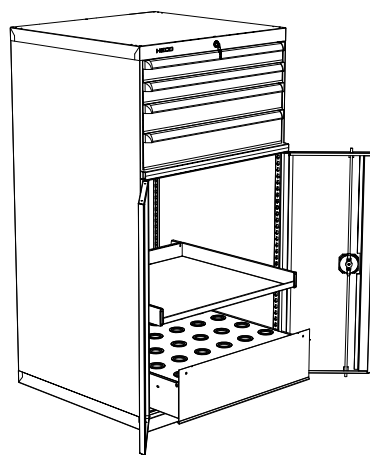

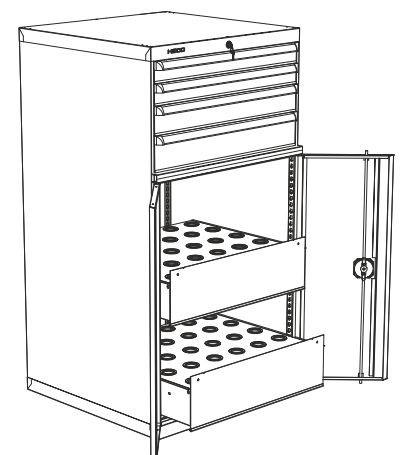

		<b>L x A x H (mm)</b>
<b>127 4 5</b>	127,5 Kg	714x730x1400
<b>cajones/tiroirs/drawers</b>	<b>armario/armoire/cabinet</b>	
 2x 115 C75 1x 115 C100 1x 115 C125	127 BE T100 bandeja extraíble plateau amovible tray removable  127 T200 50 cajón porta conos tiroir porte-cônes tool-holder drawer 	



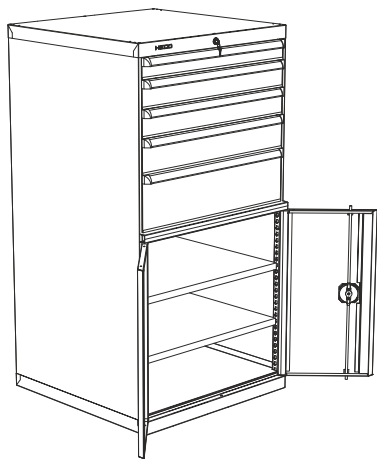

		<b>L x A x H (mm)</b>
<b>127 4 6</b>	147,5 Kg	714x730x1400
<b>cajones/tiroirs/drawers</b>	<b>armario/armoire/cabinet</b>	
 2x 115 C75 1x 115 C100 1x 115 C125	127 T200 40 cajón porta conos tiroir porte-cônes tool-holder drawer  127 T200 50 cajón porta conos tiroir porte-cônes tool-holder drawer 	

SERIE 127 5 STANDARD



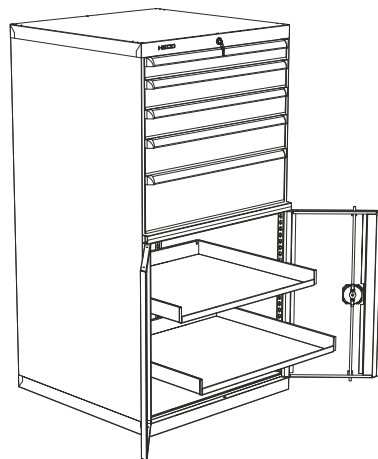

		L x A x H (mm)
127 5 1	112 Kg	714x730x1400
cajones/tiroirs/drawers	armario/armoire/cabinet	
 1x 115 C75 2x 115 C100 1x 115 C125 1x 115 C200	2x 127 BG  estanteria graduable étagère réglable adjustable shelf	



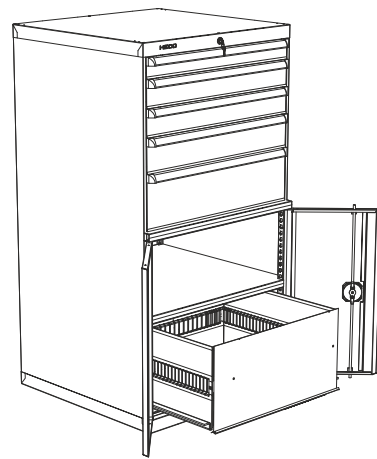

		L x A x H (mm)
127 5 2	129 Kg	714x730x1400
cajones/tiroirs/drawers	armario/armoire/cabinet	
 1x 115 C75 2x 115 C100 1x 115 C125 1x 115 C200	2x 127 BE T100  bandeja extraible plateau amovible tray removable	



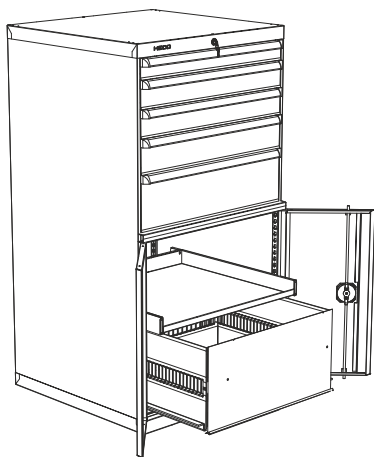

		L x A x H (mm)	
127 5 3	135,5 Kg	714x730x1400	
cajones/tiroirs/drawers	armario/armoire/cabinet		
 1x 115 C75 2x 115 C100 1x 115 C125 1x 115 C200	127 BG  estanteria graduable étagère réglable adjustable shelf  127 T100 300   cajón H:300 mm tiroir H:300mm drawer H:300mm		



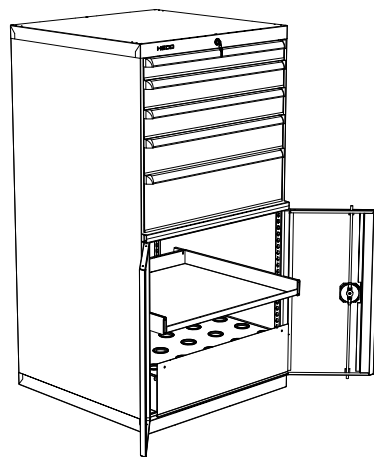

		L x A x H (mm)
127 5 4	144 Kg	714x730x1400
cajones/tiroirs/drawers	armario/armoire/cabinet	
 1x 115 C75 2x 115 C100 1x 115 C125 1x 115 C200	127 BE T100  bandeja extraible plateau amovible tray removable  127 T100 300   cajón H:300 mm tiroir H:300mm drawer H:300mm	

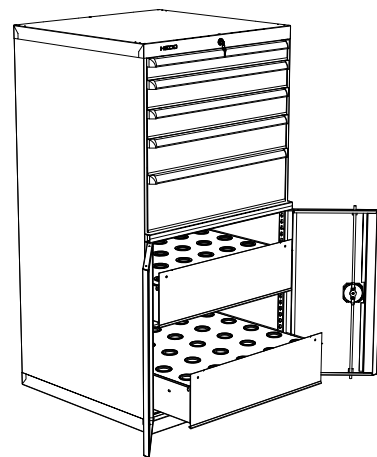

		L x A x H (mm)
127 5 5	145,5 Kg	714x730x1400
cajones/tiroirs/drawers	armario/armoire/cabinet	
 1x 115 C75 2x 115 C100 1x 115 C125 1x 115 C200	127 BE T100  bandeja extraible plateau amovible tray removable  127 T200 50   cajón porta conos tiroir porte-cônes tool-holder drawer	

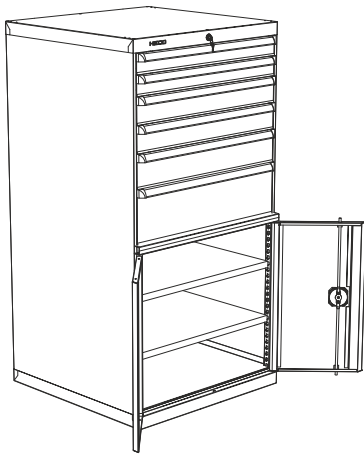

		L x A x H (mm)
127 5 6	162 Kg	714x730x1400
cajones/tiroirs/drawers	armario/armoire/cabinet	
 1x 115 C75 2x 115 C100 1x 115 C125 1x 115 C200	127 T200 40  cajón porta conos tiroir porte-cônes tool-holder drawer  127 T200 50   cajón porta conos tiroir porte-cônes tool-holder drawer	

**SERIE 127 6 STANDARD**

		<b>L x A x H (mm)</b>
<b>127 6 1</b>	121 Kg	714x730x1400
<b>cajones/tiroirs/drawers</b>	<b>armario/armoire/cabinet</b>	
 2x 115 C75 2x 115 C100 1x 115 C125 1x 115 C200	2x 127 BG  estanteria graduable étagère réglable adjustable shelf	

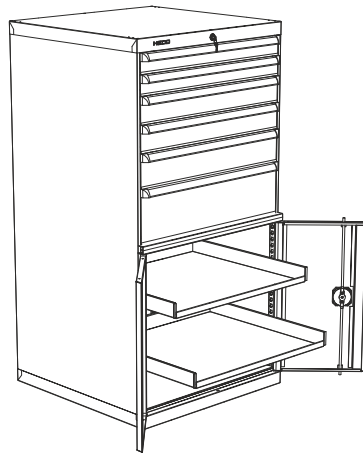

		<b>L x A x H (mm)</b>
<b>127 6 2</b>	138 Kg	714x730x1400
<b>cajones/tiroirs/drawers</b>	<b>armario/armoire/cabinet</b>	
 2x 115 C75 2x 115 C100 1x 115 C125 1x 115 C200	2x 127 BE T100  bandeja extraíble plateau amovible tray removable	

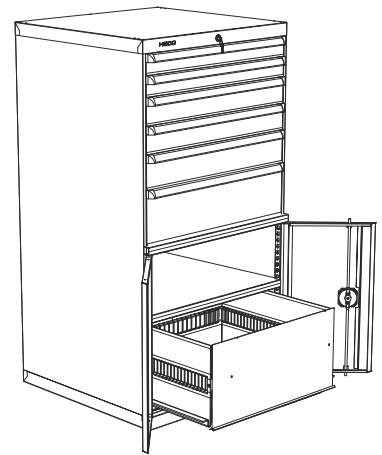

		<b>L x A x H (mm)</b>	
<b>127 6 3</b>	144,5 Kg	714x730x1400	
<b>cajones/tiroirs/drawers</b>	<b>armario/armoire/cabinet</b>		
 2x 115 C75 2x 115 C100 1x 115 C125 1x 115 C200	127 BG  estanteria graduable étagère réglable adjustable shelf  127 T100 300   cajón H:300 mm tiroir H:300mm drawer H:300mm		

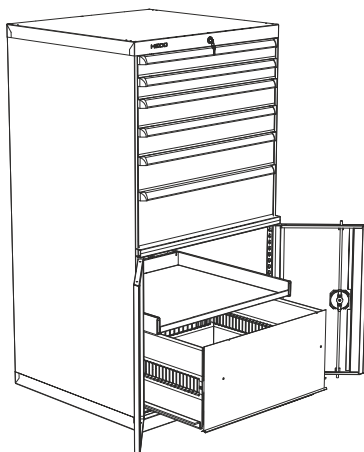

		<b>L x A x H (mm)</b>
<b>127 6 4</b>	153 Kg	714x730x1400
<b>cajones/tiroirs/drawers</b>	<b>armario/armoire/cabinet</b>	
 2x 115 C75 2x 115 C100 1x 115 C125 1x 115 C200	127 BE T100  bandeja extraíble plateau amovible tray removable  127 T100 300   cajón H:300 mm tiroir H:300mm drawer H:300mm	

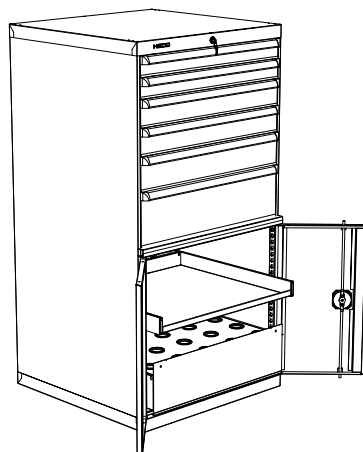

		<b>L x A x H (mm)</b>
<b>127 6 5</b>	154,5 Kg	714x730x1400
<b>cajones/tiroirs/drawers</b>	<b>armario/armoire/cabinet</b>	
 2x 115 C75 2x 115 C100 1x 115 C125 1x 115 C200	127 BE T100  bandeja extraíble plateau amovible tray removable  127 T200 50   cajón porta conos tiroir porte-cônes tool-holder drawer	

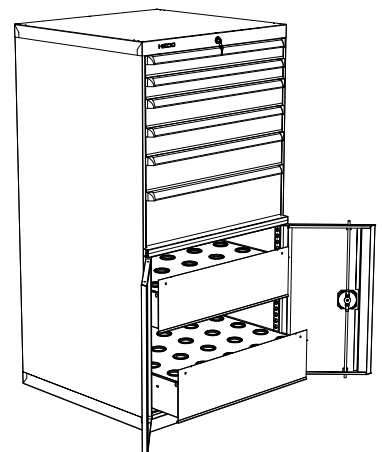

		<b>L x A x H (mm)</b>	
<b>127 6 6</b>	171 Kg	714x730x1400	
<b>cajones/tiroirs/drawers</b>	<b>armario/armoire/cabinet</b>		
 2x 115 C75 2x 115 C100 1x 115 C125 1x 115 C200	127 T200 40  cajón porta conos tiroir porte-cônes tool-holder drawer  127 T200 50   cajón porta conos tiroir porte-cônes tool-holder drawer		

SERIE 127 STANDARD

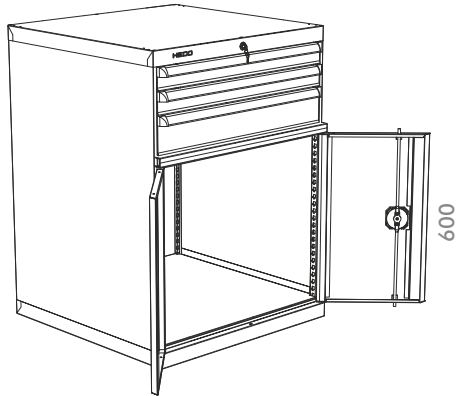

		LxAxH (mm)		cajones/tiroirs/drawers	
127 3	77,5 Kg	714x730x1000	GI	2x 115 C75	1x 115 C125
	0,648 m <sup>3</sup>	742x760x1150			

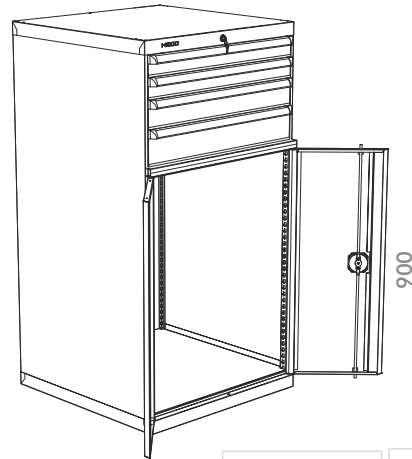

		LxAxH (mm)		cajones/tiroirs/drawers	
127 4	109 Kg	714x730x1400	GI	2x 115 C75	1x 115 C100
	0,874 m <sup>3</sup>	742x760x1550		1x 115 C125	

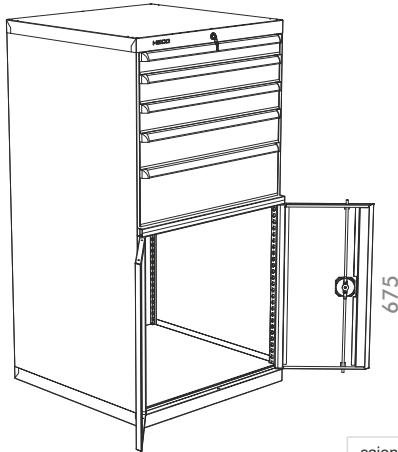

		LxAxH (mm)		cajones/tiroirs/drawers	
127 5	96,5 Kg	714x730x1000	GI	1x 115 C75	2x 115 C100
	0,874 m <sup>3</sup>	742x760x1550		1x 115 C125	1x 115 C200

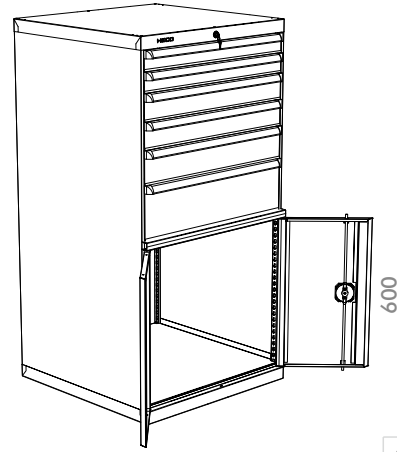

		LxAxH (mm)		cajones/tiroirs/drawers	
127 6	112 Kg	714x730x1400	GI	2x 115 C75	2x 115 C100
	0,874 m <sup>3</sup>	742x760x1550		1x 115 C125	1x 115 C200

INFO

ESTANTERIAS Y CAJONES / ÉTAGÈRES ET TIROIRS / SHELVES AND DRAWERS

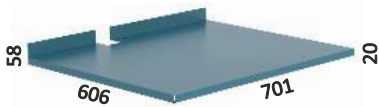

127 BG



4 Kg



127 BE T100

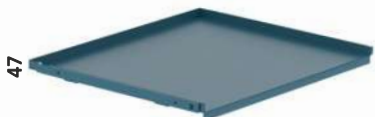

127 BE T200

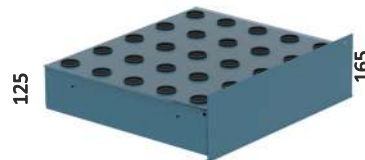

127 T200 50



25 Porta Conos ISO 50  
25 Porte-Cônes ISO 50  
25 Tool-Holder ISO 50

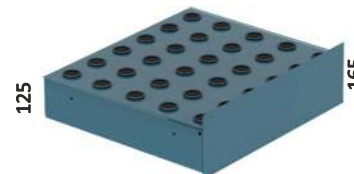

127 T200 40



25 Porta Conos ISO 40  
25 Porte-Cônes ISO 40  
25 Tool-Holder ISO 40

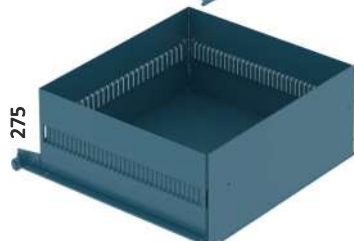

127 T100 300





Consultar plazo de entrega.  
Consulter le délai de livraison.  
Check delivery time.



Configuraciones personalizadas según las necesidades del cliente.  
Configurations personnalisées selon les besoins du client.  
Customized configurations according to the needs of the client.

**SERIE 115 C**

Armario esquinero con y sin puertas (H:1000mm).  
Armoire d'angle avec ou sans portes (H: 1000 mm).  
Corner cabinet with or without doors (H:1000 mm).



	LxAxH (mm)
115 C	1007x1007x1000
115 CP	810x910x1000
115 CV	1007x1007x1000

1 mm



Para armarios bajos de 707 mm de profundidad.  
Pour armoires basses de 707 mm de profondeur.  
For low cabinets of 707 mm depth.

**SERIE 115 C**

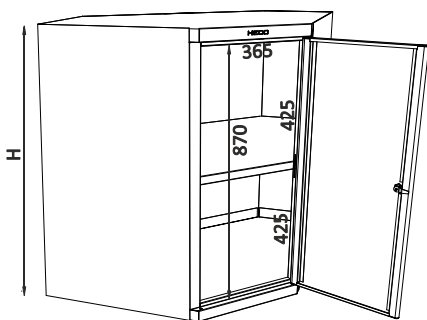

115 C



sin puertas  
sans portes  
without doors

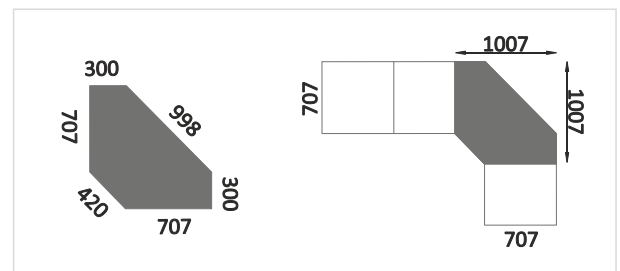

	LxAxH (mm)
115 C	67 Kg   1 m <sup>3</sup>   1007x1007x1000

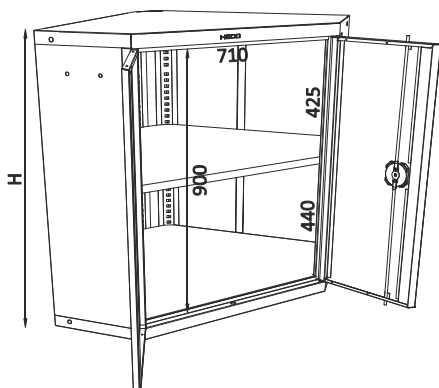

115 CP



con puertas  
avec portes  
with doors

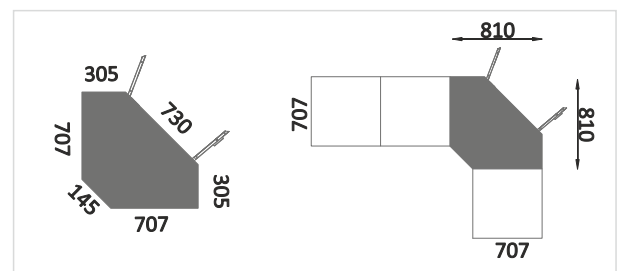

	LxAxH (mm)
115 CP	31,5 Kg   0,651 m <sup>3</sup>   810x810x1000

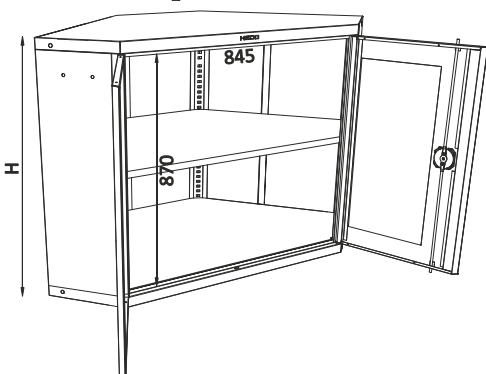

115 CV



con puertas de metacrilato  
avec portes en méthacrylate  
with methacrylate doors

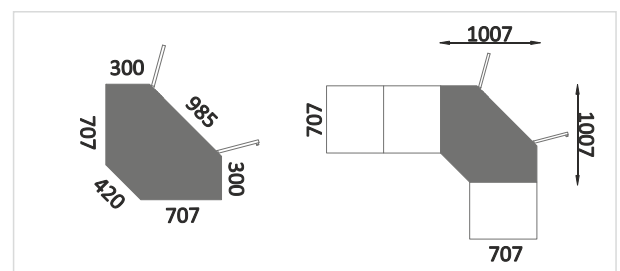

	LxAxH (mm)
115 CV	31,5 Kg   0,651 m <sup>3</sup>   1007x1007x1000



## SERIE 122 C

Armario esquinero con y sin puertas (H:1000mm).  
 Armoire d'angle avec ou sans portes (H:1000 mm).  
 Corner cabinet with or without doors (H:1000 mm).



122 C



122 CP

	LxAxH (mm)
122 C	900x900x1000
122 CP	810x810x1000

1 mm



Para armarios bajos de 600 mm de profundidad.  
 Pour armoires basses de 600 mm de profondeur.  
 For low cabinets of 600 mm depth.

## SERIE 122 C

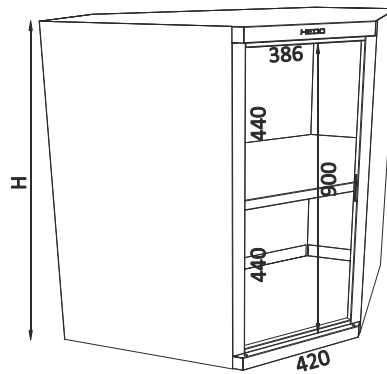
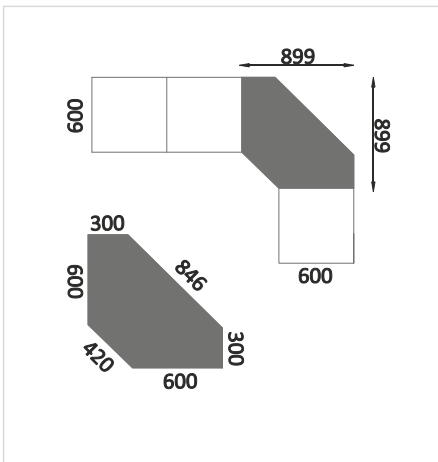

	LxAxH (mm)
122 C	67 Kg, 0,804 m <sup>3</sup> , 900x900x1000

\* sin puertas / sans portes / without doors

## SERIE 122 CP

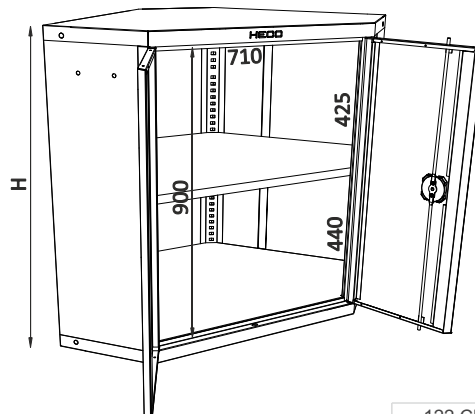
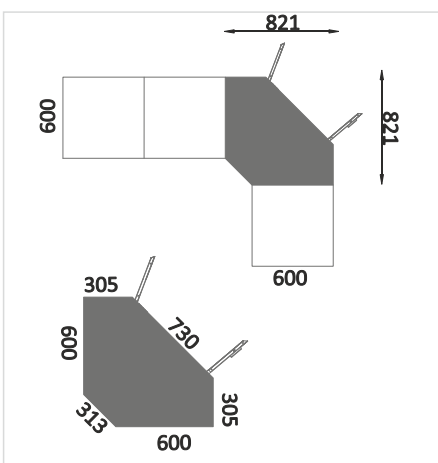

	LxAxH (mm)
122 CP	31,5 Kg, 0,651 m <sup>3</sup> , 810x810x1000

\* con puertas / avec portes / with doors

MOSTRADOR: ARMARIOS CON CAJONES  
COMPTOIR: ARMOIRES AVEC TIROIRS  
COUNTER: CABINETS WITH DRAWERS



Para más información de configuraciones, ver PAG. 13.  
Pour plus d'information de configurations voir PAGE. 13.  
For further information of configurations see PAGE. 13.

MOSTRADOR: ARMARIOS CON PUERTAS  
COMPTOIR: ARMOIRES AVEC PORTES  
COUNTER: CABINETS WITH DOORS



Para más información de configuraciones, ver PAG. 55.  
Pour plus d'information de configurations voir PAGE. 55.  
For further information of configurations see PAGE. 55.

MOSTRADOR: ARMARIOS SIN PUERTAS  
COMPTOIR: ARMOIRES SANS PORTES  
COUNTER: CABINETS WITHOUT DOORS

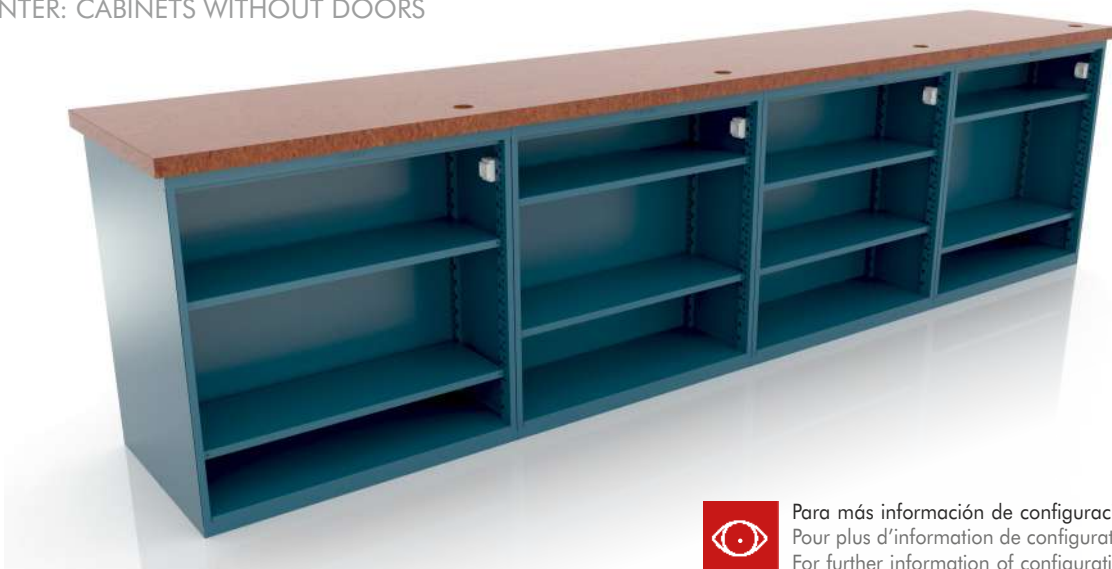

Para más información de configuraciones, ver PAG. 141.  
Pour plus d'information de configurations voir PAGE. 141.  
For further information of configurations see PAGE. 141.



**SERIE 304 BV** ref. 304 BV 10 / 304 BV 15 / 304 BV 20

Bancos en acero inoxidable.  
 Bancs de vestiaire en acier inoxydable.  
 Stainless-steel bench.

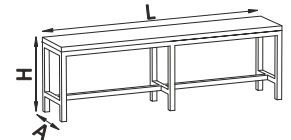
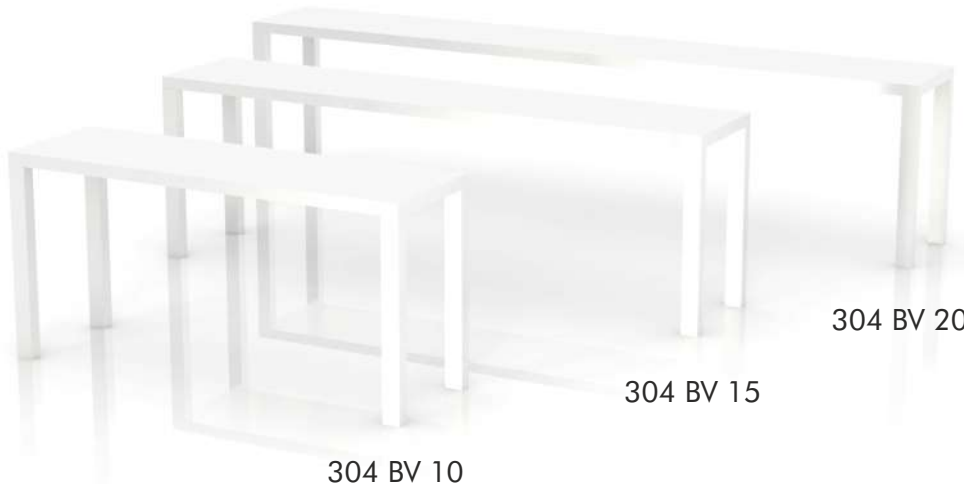

	LxAxH (mm)
304 BV 10	1000x300x450
304 BV 15	1500x300x450
304 BV 20	2000x300x450

1 mm



Consultar plazo de entrega.  
 Consulter le delai de livraison.  
 Check delivery time.

**SERIE 304 BV STANDARD**

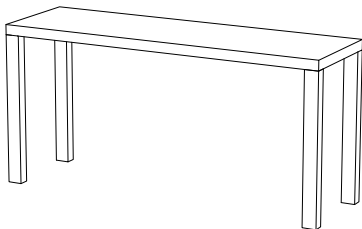

		LxAxH (mm)
304 BV 10	11 Kg	1000x300x450

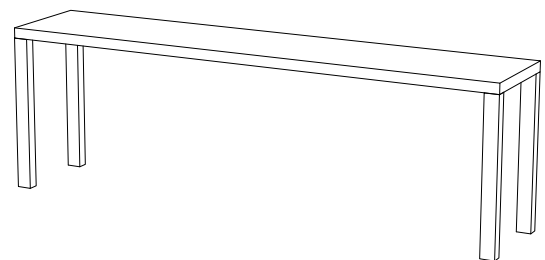

		LxAxH (mm)
304 BV 15	14,75 Kg	1500x300x450

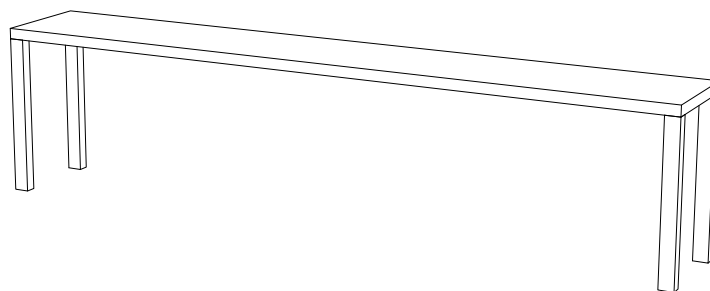

		LxAxH (mm)
304 BV 20	18,5 Kg	2000x300x450

**SERIE 304 BT** ref. 304 BT 15 / 304 BT 20 / 304 BT 30

Banco de trabajo en acero inoxidable.  
 Établi de travail en acier inoxydable.  
 Stainless-steel workbenches.

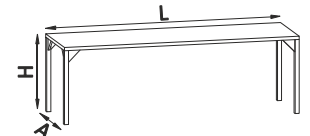

304 BT 30

304 BT 20

304 BT 15

	LxAxH (mm)
304 BT 15	1400x800x900
304 BT 20	1900x900x900
304 BT 30	2900x900x900

2 mm



Consultar plazo de entrega.  
 Consulter le délai de livraison.  
 Check delivery time.

**SERIE 304 BT STANDARD**

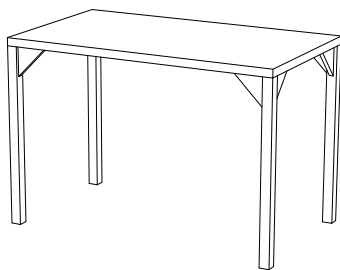

		LxAxH (mm)
304 BT 15	46 Kg	1500x800x900

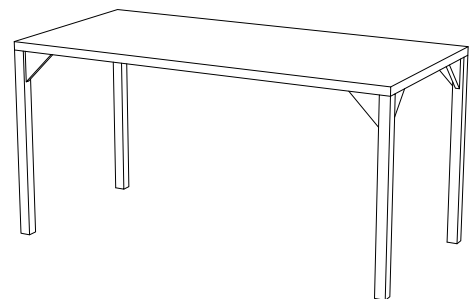

		LxAxH (mm)
304 BT 20	60 Kg	1900x900x900

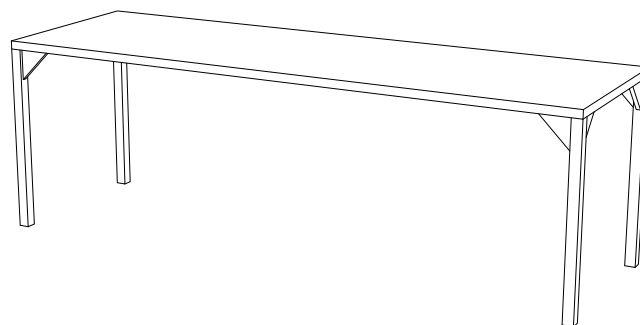

		LxAxH (mm)
304 BT 30	100 Kg	2900x900x900

**SERIE 304 1**

Armario vestuario en acero inoxidable.  
 Armoire vestiaire en acier inoxydable.  
 Stainless-steel lockers.

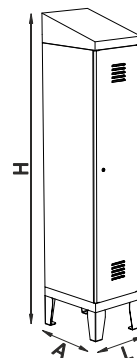

	LxAxH (mm)
304 1	310x450x2100
304 1 2	620x450x2100
304 1 3	930x450x2100
304 1 4	1240x450x2100
304 1 5	1550x450x2100

**e** 1 mm

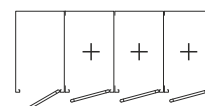

**i** Permite agrupar hasta 5 módulos.  
 Permet de regrouper un maximum de 5 modules.  
 Up to 5 modules can be grouped together.

**i** Consultar plazo de entrega.  
 Consulter le délai de livraison.  
 Check delivery time.

**SERIE 304 1 STANDARD**

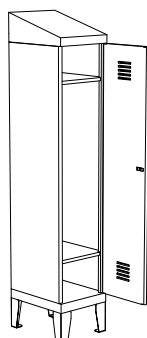
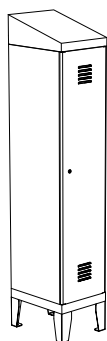

		LxAxH (mm)
304 1	30,3 Kg	310x450x2100

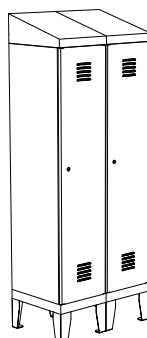

		LxAxH (mm)
304 1 2	60,6 Kg	600x450x2100

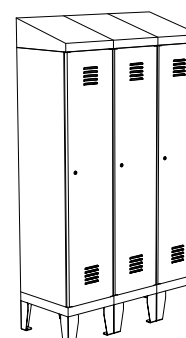

		LxAxH (mm)
304 1 3	90,9 Kg	882x450x2100



		LxAxH (mm)
304 1 4	121,2 Kg	1170x450x2100



		LxAxH (mm)
304 1 5	151,5 Kg	1452x450x2100

## SERIE 304 2

Armario vestuario en acero inoxidable. Con dos puertas.  
 Armoire vestiaire en acier inoxydable. Avec deux portes.  
 Stainless-steel lockers. With two doors.

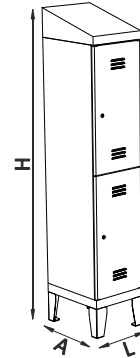

	LxAxH (mm)
304 2	310x450x2100
304 2 2	620x450x2100
304 2 3	930x450x2100
304 2 4	1240x450x2100
304 2 5	1550x450x2100

**e** 1 mm

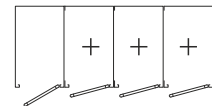

Consultar plazo de entrega.  
 Consulter le délai de livraison.  
 Check delivery time.



Permite agrupar hasta 5 módulos.  
 Permet de regrouper un maximum de 5 modules.  
 Up to 5 modules can be grouped together.

## SERIE 304 2 STANDARD

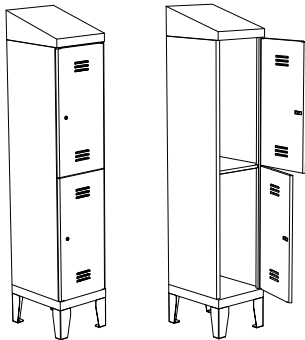

		LxAxH (mm)
304 2	30,6 Kg	310x450x2100

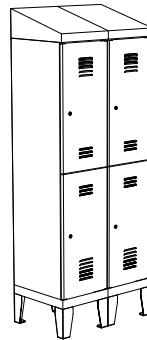

		LxAxH (mm)
304 2 2	61,2 Kg	600x450x2100



		LxAxH (mm)
304 2 3	91,8 Kg	882x450x2100

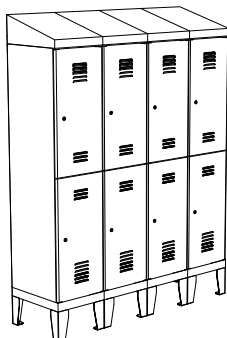

		LxAxH (mm)
304 2 4	122,4 Kg	1170x450x2100



		LxAxH (mm)
304 2 5	153 Kg	1452x450x2100

**SERIE 304 3**

Armario vestuario en acero inoxidable.  
 Armoire vestiaire en acier inoxydable.  
 Stainles-steel cabinet.

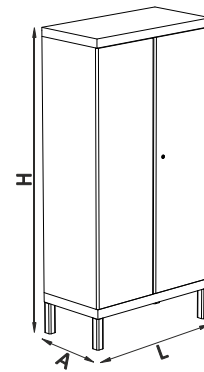

	LxAxH (mm)
304 3	980x450x2000
304 3 TI	980x450x2000
304 4	950x450x2100

304 3

304 3 TI-304 4

**e** 1 mm



Consultar plazo de entrega.  
 Consulter le délai de livraison.  
 Check delivery time.

**SERIE 304 3 STANDARD**

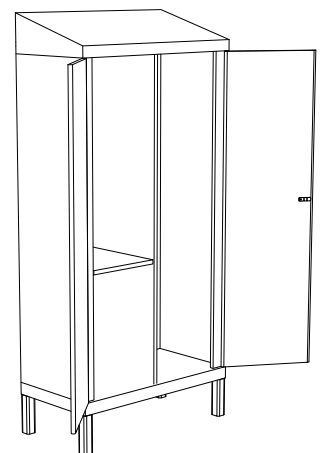
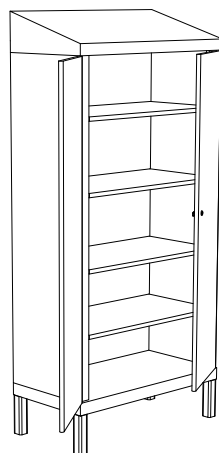
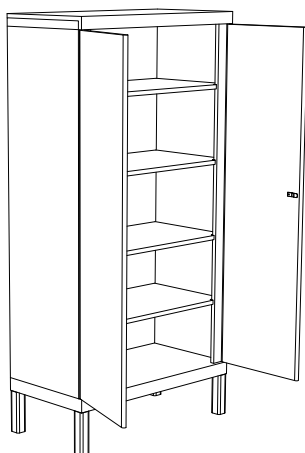

		LxAxH (mm)
304 3	80 Kg	980x450x2000

		LxAxH (mm)
304 3 TI	85 Kg	980x450x2000

		LxAxH (mm)
304 4	65 Kg	950x450x2100



## SERIE 170

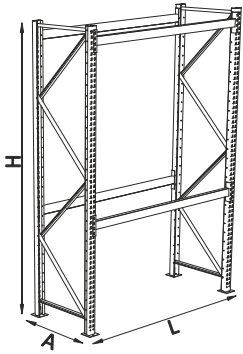

	LxAxH (mm)
170 19 08 01	1900x800x3000
170 19 10 01	1900x1000x3000
170 27 08 01	2700x800x3000
170 27 10 01	2700x1000x3000

**e** 1 mm



Colores estándar. **RAL 5017 /**  
Couleurs Standard. **RAL 2009**



Módulos adicionales.  
Modules additionnels.  
Additional modules.



Plazo de entrega 10 días laborables.  
Délai de livraison 10 jours ouvrables.  
Delivery time 10 working days.



Resistencia: 1000 kg por estante.  
Résistance: 1000 kg par étagère.  
Resistance: 1000 kg pour shelf.



Las patas laterales se sirven montadas.  
Les pattes latérales sont servies montés.  
Side covers are delivered assembled.

## SERIE 170 STANDARD

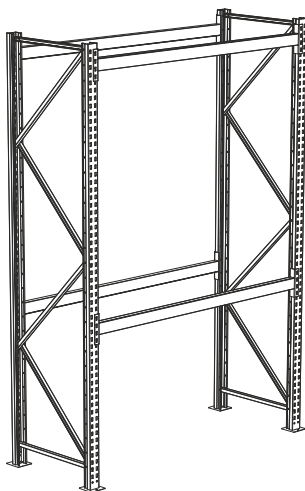

		LxAxH (mm)
170 19 08 01	105 Kg	1900x800x3000

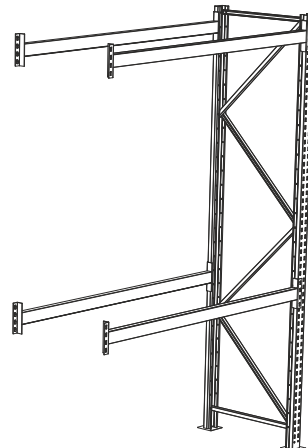

Carga total repartida por estante.  
Charge totale répartie pour étagère.  
Distributed total load for shelf.

1000

		LxAxH (mm)
170 19 08 02	75 Kg	1900x800x3000

Módulos adicionales. / Modules additionnels. / Additional modules.

SERIE 170 STANDARD



Carga total repartida por estante.  
 Charge totale répartie pour étagère.  
 Distributed total load for shelf.

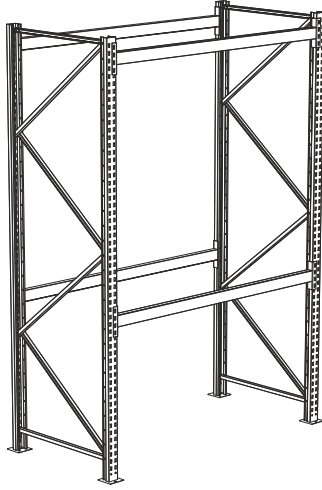

		LxAxH (mm)
170 19 10 01	109 Kg	1900x1000x3000

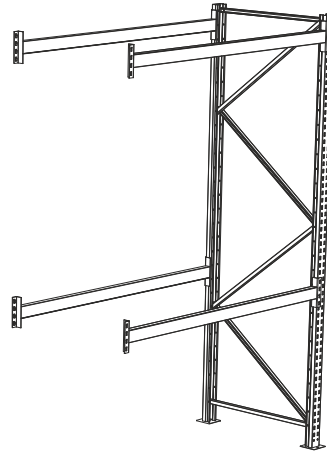

		LxAxH (mm)
170 19 10 02	77 Kg	1900x1000x3000

Módulos adicionales. / Modules additionnels. / Additional modules.

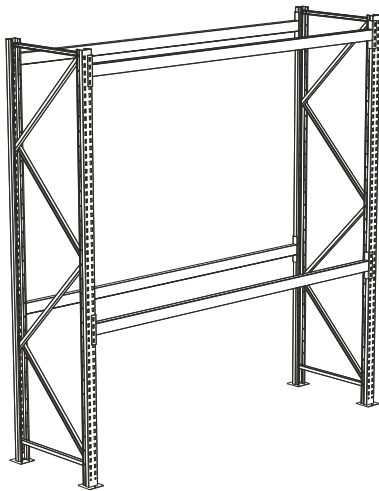

		LxAxH (mm)
170 27 08 01	117 Kg	2700x800x3000

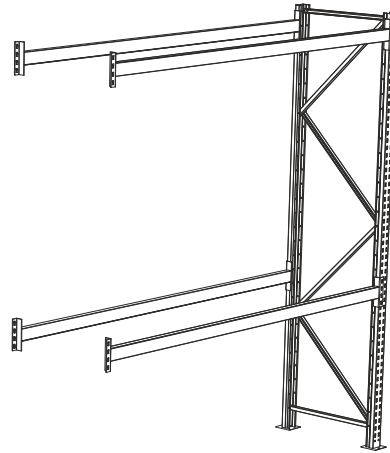

		LxAxH (mm)
170 27 08 02	87 Kg	2700x800x3000

Módulos adicionales. / Modules additionnels. / Additional modules.

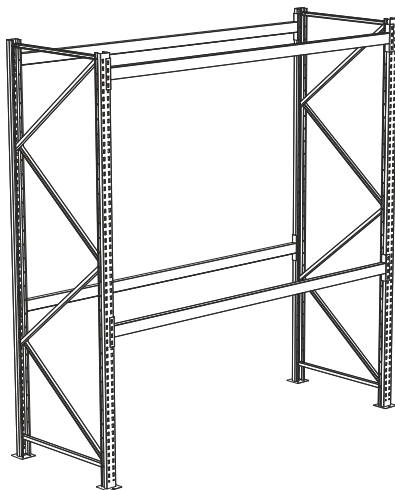

		LxAxH (mm)
170 27 10 01	121 Kg	2700x1000x3000

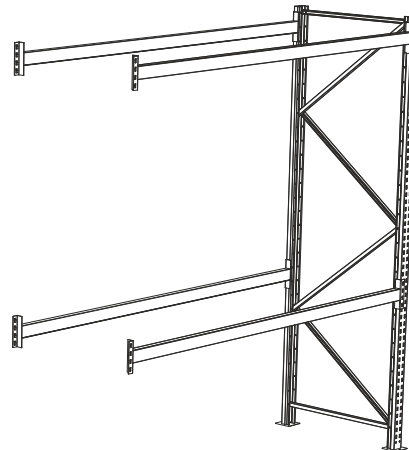

		LxAxH (mm)
170 27 10 02	89 Kg	2700x1000x3000

Módulos adicionales. / Modules additionnels. / Additional modules.

# SERIE 170 COMPONENTES / COMPOSANTS / COMPONENTS

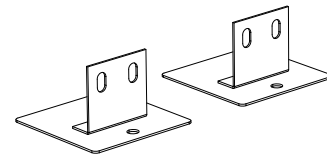
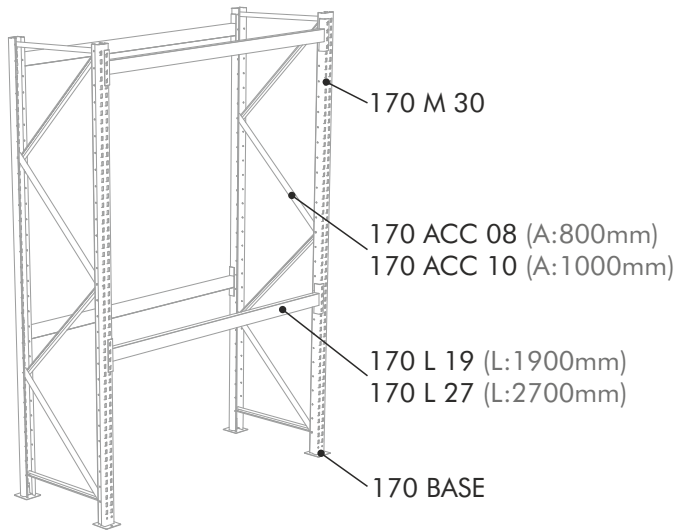

170 BASE	two units juego de dos un jeu de deux
----------	---

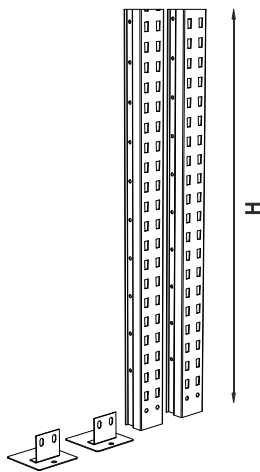

		H (mm)
170 M 30	23 Kg	3000

juego de dos / un jeu de deux / two units  
170 BASE incluidas / inclus / included

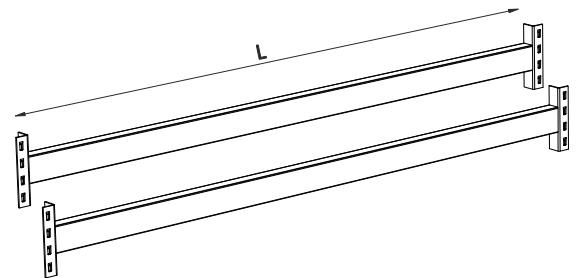

		L (mm)
170 L 19	25 Kg	1900
170 L 27	27 Kg	2700

juego de dos / un jeu de deux / two units

### INCLUYE

Riostras galvanizadas;  
(P800-P1000)  
Separadores y tornillería.

### COMPREND

Appareils dentaires galvanisés;  
(P800-P1000)  
Séparateurs et vis.

### INCLUDES

Galvanized braces;  
(P800-P1000)  
Dividers and screws.

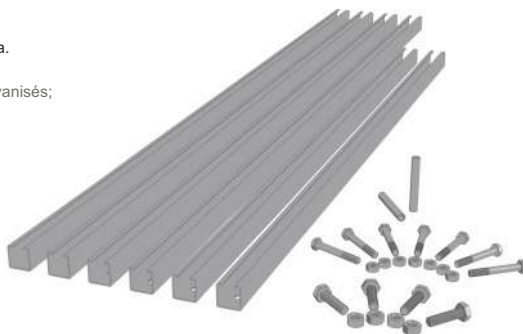

		A (mm)
170 ACC 08	8,5 Kg	800
170 ACC 10	10 Kg	1000

juego de accesorios / jeu d'accessoires / accessory set  
zincado / zingué / zined

### PLATAFORMAS / PLATEFORMES / PLATFORMS

TAP-09012

X: 800

TAP-09001

X: 1000 mm

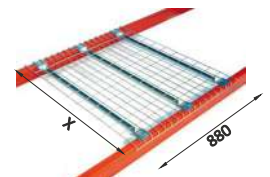

		LxAxH (mm)
TAP-09012	A:800mm	880x800
TAP-09001	A:1000mm	880x1000

SERIE 170

PROTECCIONES DE PUNTAL / PROTECTIONS DES PATTES / LEG PROTECTIONS.

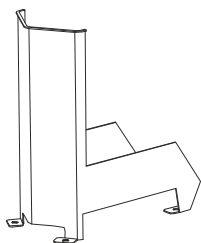

	LxAxH (mm)
TAP-10930	335x168x400

Protección "push back".  
 Protection "push back".  
 Push back protection.

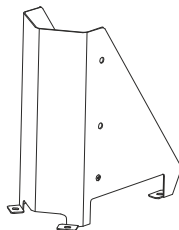

	LxAxH (mm)
TAP-10931	334x168x400

Protección de acero.  
 Protection d'acier.  
 Steel protection.

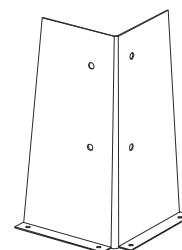

	LxAxH (mm)
TAP-10933	160x160x400

Protección de esquina.  
 Protection de coin.  
 Corner protection.

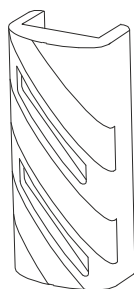

	LxAxH (mm)
TAP-35019	135x80x400

Protección magnética.  
 Protection magnétique.  
 Magnetic protection.

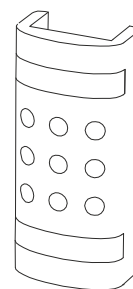

	LxAxH (mm)
TAP-35017	160x145x470

Protección con eslingas.  
 Protection avec élingues.  
 Protection with slings.

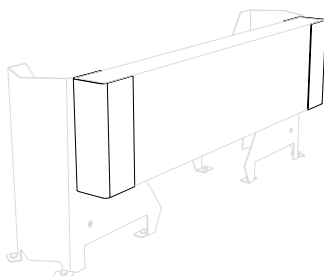

	LxAxH (mm)
TAP-10000	334x168x400

Soporte para tablero.  
 Support pour panneau.  
 Board support.

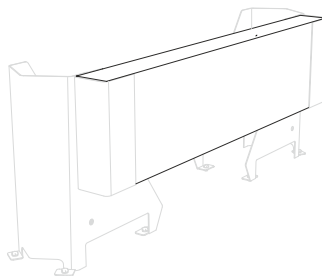

	LxAxH (mm)
TAP-35050	1150x225x75

Tablero de pino.  
 Panneau de pin.  
 Pine board.

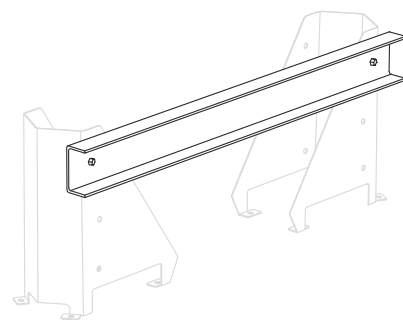

	LxAxH (mm)
TAP-10936	1000x50x100

Protección lateral.  
 Protection latérale.  
 Side protection.



Consultar plazo de entrega.  
 Consulter le délai de livraison.  
 Check delivery time.