

## ARMOIRES A TIROIRS

## CABINETS WITH DRAWERS

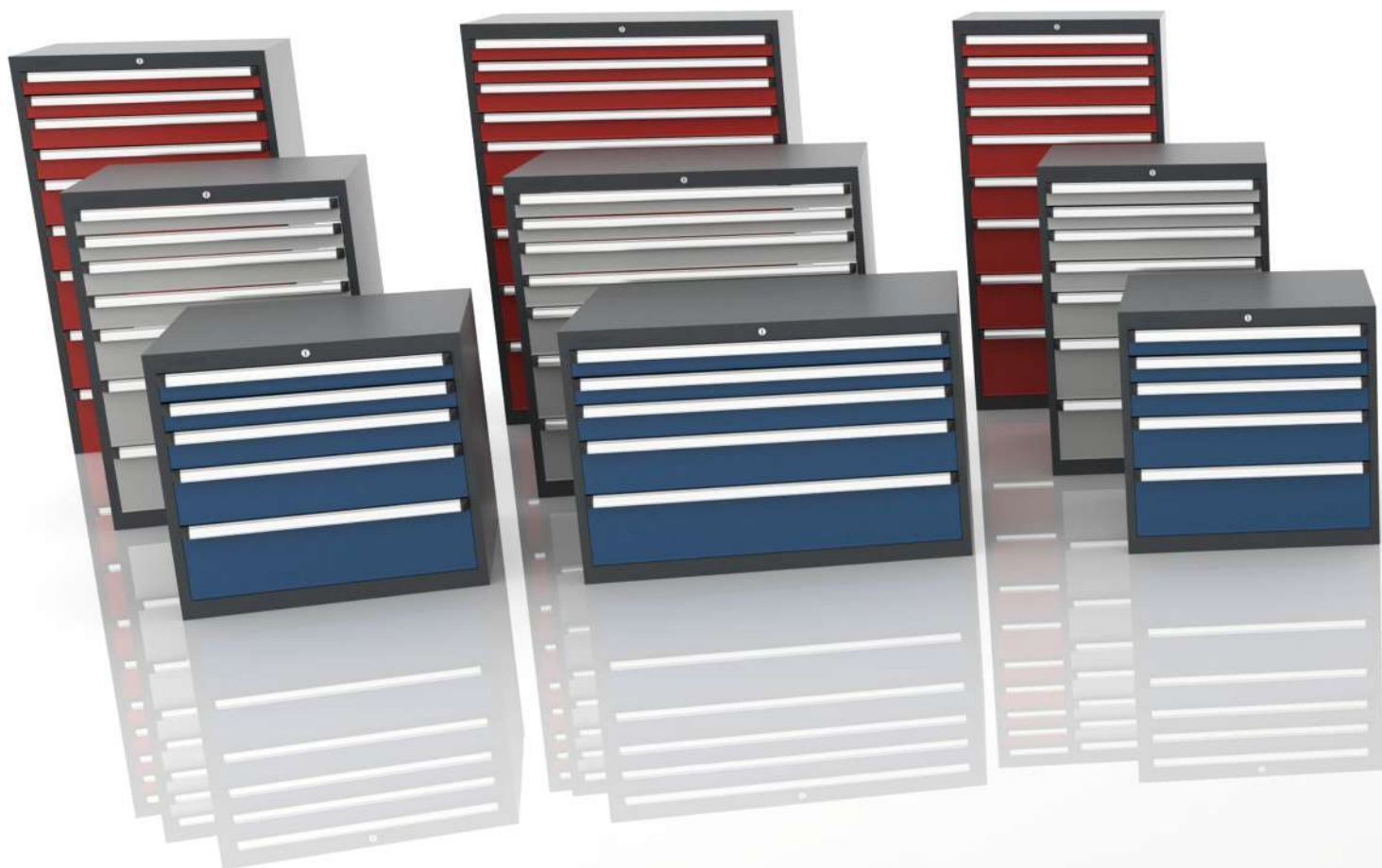

FR

- Grande variété de tailles et configurations.
- Conception robuste et résistante.
- Verrouillage centralisé.
- Système anti-renversement.
- Glissières à roulements.
- Poignées en aluminium avec porte-étiquettes.
- Tiroirs rainurés avec séparateurs pour la classification.
- Système RFID en option.
- Délai de livraison 10 jours ouvrables.
- Couleur standard bleu martelé possibilité teintes en option.

EN

- Wide range of sizes and configurations.
- Strong and resistant design.
- Central locking.
- Anti-roll system.
- Bearing slides.
- Aluminum handles with label holders.
- Grooved drawers with dividers.
- Optional RFID system.
- Delivery time 10 working days.
- Standard colour hammered blue possibility optional colours.

## SERIE 115

ref. 115 1 / 115 2 / 115 4

Sistema antivuelco.  
Système anti-renversement.  
Anti-roll system.

Cierre centralizado.  
Verrouillage centralisé.  
Central locking.



SERIE 115 4

SERIE 115 2

SERIE 115 1

Guías simples o telescópicas.  
Glissières simples ou télescopiques.  
Simple or telescopic slides.

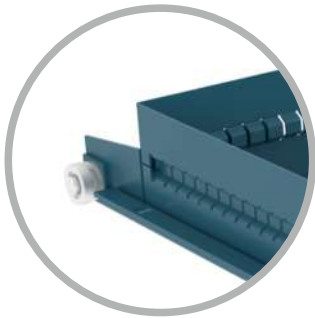

**GS** Apertura 90%.  
Ouverture 90%.  
90% opening.

**GT** Apertura 100%.  
Ouverture 100%.  
100% opening.

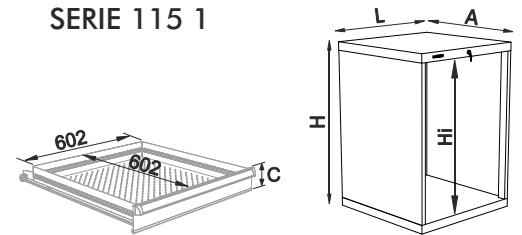

		LxAxH (mm)	Hi (mm)
115 1	42 Kg	714x707x700	600
115 2	49 Kg	714x707x1000	900
115 4	56 Kg	714x707x1400	1300

**e** 1 mm

SERIE 115	C=50	GS 100 KG		GT 50 KG		GT 100 KG		GT 200 KG		GT 200 KG		PORTACONOS PORTE-CÔNES TOOL HOLDER		
	C=75	●	115 S100 C75	9Kg	●	115 T50 C75	6Kg	●	115 T100 C50	10,5Kg	●	115 T200 C75	15Kg	
	C=100	●	115 S100 C100	10,5Kg	●	115 T50 C100	7Kg	●	115 T100 C75	11Kg	●	115 T200 C100	16Kg	115 T200 ISO 40
	C=125	●	115 S100 C125	11Kg	●	115 T50 C125	7,5Kg	●	115 T100 C100	12,5Kg	●	115 T200 C125	17Kg	115 T200 HSK 50
	C=150	●	115 S100 C150	12,5Kg	●	115 T50 C150	8,5Kg	●	115 T100 C125	13Kg	●	115 T200 C150	18Kg	115 T200 HSK 63
	C=200	●	115 S100 C200	13Kg	●	115 T50 C200	9,5Kg	●	115 T100 C150	13,5Kg	●	115 T200 C200	19,5Kg	115 T200 HSK 80
	C=250	●	115 S100 C250	14Kg	●	115 T50 C250	10,5Kg	●	115 T100 C200	14,5Kg	●	115 T200 C250	20,5Kg	115 T200 ISO 50
	C=300													115 T200 HSK 100 28Kg
			<b>e</b> 1.5 mm			<b>e</b> 1 mm			<b>e</b> 1.5 mm			<b>e</b> 1.5 mm		



ACCESORIOS. Ver información (PAG. 289).  
ACCESOIRES. Voir information (PAG. 289).  
ACCESORIES. See information (PAG. 289).



Los cajones no incluyen divisiones.  
Les tiroirs n'inclus pas les séparations.  
Divisions for drawers no included.

SERIE 115 1 STANDARD

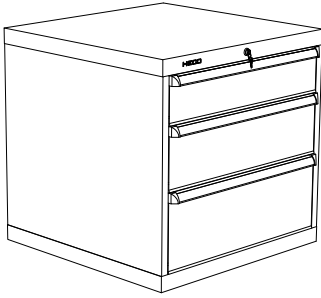

cajones/tiroirs/drawers			
115 1 01	71 Kg	GI 50	
115 1 11	82 Kg	GS 100	1x 115 C150
115 1 21	85,5 Kg	GI 100	1x 115 C250
115 1 31	100 Kg	GI 200	

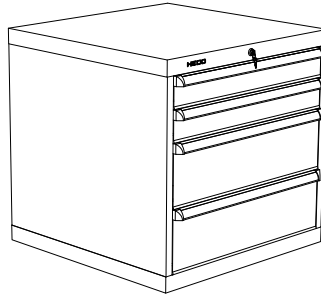

cajones/tiroirs/drawers			
115 1 02	77 Kg	GI 50	
115 1 12	89 Kg	GS 100	2x 115 C100
115 1 22	96 Kg	GI 100	2x 115 C200
115 1 32	113 Kg	GI 200	

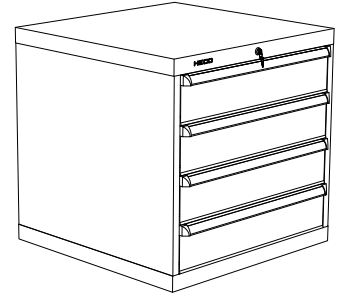

cajones/tiroirs/drawers			
115 1 03	76 Kg	GI 50	
115 1 13	92 Kg	GS 100	4x 115 C150
115 1 23	96 Kg	GI 100	
115 1 33	114 Kg	GI 200	

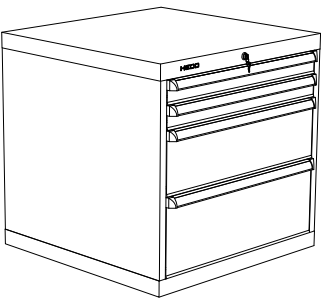

cajones/tiroirs/drawers			
115 1 04	74 Kg	GI 50	2x 115 C75
115 1 14	87 Kg	GS 100	1x 115 C200
115 1 34	112 Kg	GI 200	1x 115 C250
115 1 24	95 Kg	GI 100	1x 115 C50 1x 115 C100 1x 115 C200 1x 115 C250

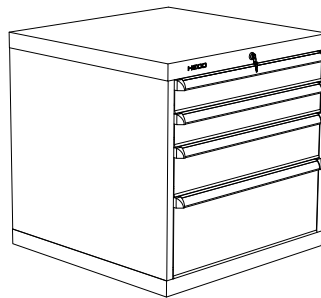

cajones/tiroirs/drawers			
115 1 05	75 Kg	GI 50	2x 115 C100
115 1 15	90 Kg	GS 100	1x 115 C150
115 1 35	113 Kg	GI 200	1x 115 C250
115 1 25	103,5 Kg	GI 100	1x 115 C50 2x 115 C75 1x 115 C150 1x 115 C250

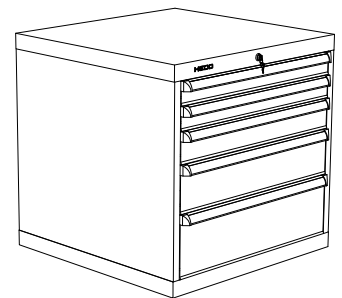

cajones/tiroirs/drawers			
115 1 06	80 Kg	GI 50	2x 115 C75
115 1 16	96 Kg	GS 100	1x 115 C100
115 1 26	104,5 Kg	GI 100	1x 115 C150
115 1 36	126 Kg	GI 200	1x 115 C200

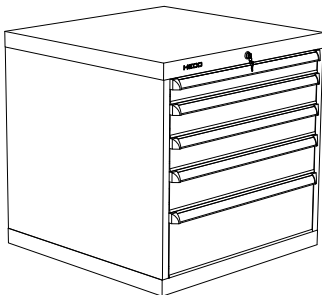

cajones/tiroirs/drawers			
115 1 07	79 Kg	GI 50	1x 115 C75
115 1 17	96 Kg	GS 100	2x 115 C100
115 1 27	105,5 Kg	GI 100	1x 115 C125
115 1 37	126 Kg	GI 200	1x 115 C200

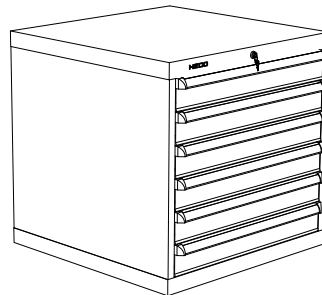

cajones/tiroirs/drawers			
115 1 08	84 Kg	GI 50	
115 1 18	105 Kg	GS 100	6x 115 C100
115 1 28	117 Kg	GI 100	
115 1 38	138 Kg	GI 200	

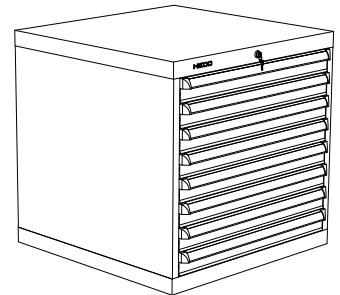

cajones/tiroirs/drawers			
115 1 09	90 Kg	GI 50	
115 1 19	114 Kg	GS 100	8x 115 C75
115 1 29	130 Kg	GI 100	
115 1 39	162 Kg	GI 200	

# SERIE 115 2 STANDARD



cajones/tiroirs/drawers

115 2 01	94 Kg	GI 50	1x 115 C100
115 2 11	112 Kg	GS 100	4x 115 C200
115 2 31	143 Kg	GI 200	
115 2 21	128,5 Kg	GI 100	1x 115 C75 1x 115 C100 1x 115 C125 1x 115 C150 1x 115 C200 1x 115 C250



cajones/tiroirs/drawers

115 2 02	98 Kg	GI 50	1x 115 C75 1x 115 C100
115 2 12	119 Kg	GS 100	1x 115 C125 1x 115 C150 1x 115 C200 1x 115 C250
115 2 32	155 Kg	GI 200	
115 2 22	130 Kg	GI 100	6x 115 C150



cajones/tiroirs/drawers

115 2 03	100 Kg	GI 50	
115 2 13	124 Kg	GS 100	6x 115 C150
115 2 33	172 Kg	GI 200	
115 2 23	137,5 Kg	GI 100	3x 115 C75 1x 115 C100 1x 115 C125 1x 115 C200 1x 115 C250



cajones/tiroirs/drawers

115 2 04	102 Kg	GI 50	3x 115 C75 1x 115 C100
115 2 14	125 Kg	GS 100	1x 115 C125 1x 115 C200
115 2 34	167 Kg	GI 200	1x 115 C250
115 2 24	148 Kg	GI 100	2x 115 C50 1x 115 C75 2x 115 C100 1x 115 C125 2x 115 C200



cajones/tiroirs/drawers

115 2 05	107 Kg	GI 50	2x 115 C75
115 2 15	135 Kg	GS 100	2x 115 C100 2x 115 C125
115 2 35	181 Kg	GI 200	2x 115 C150
115 2 25	157,5 Kg	GI 100	2x 115 C50 2x 115 C75 2x 115 C100 2x 115 C125 1x 115 C200



cajones/tiroirs/drawers

115 2 06	80 Kg	GI 50	
115 2 16	142 Kg	GS 100	3x 115 C75 4x 115 C100
115 2 26	158,5 Kg	GI 100	1x 115 C125 1x 115 C150
115 2 36	193 Kg	GI 200	

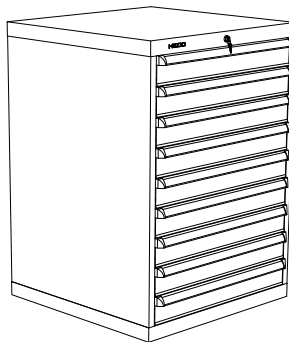

cajones/tiroirs/drawers

115 2 07	112 Kg	GI 50	
115 2 17	144 Kg	GS 100	
115 2 27	161,5 Kg	GI 100	9x 115 C100
115 2 37	193 Kg	GI 200	

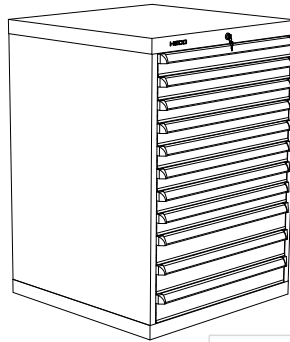

cajones/tiroirs/drawers

115 2 08	118 Kg	GI 50	8x 115 C75
115 2 18	153 Kg	GS 100	3x 115 C100
115 2 38	217 Kg	GI 200	
115 2 28	175 Kg	GI 100	3x 115 C50 6x 115 C75 3x 115 C100

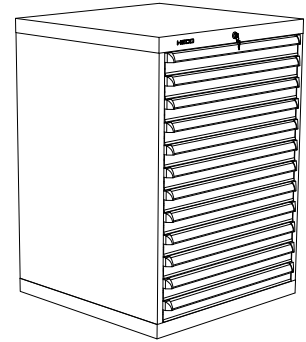

cajones/tiroirs/drawers

115 2 09	121 Kg	GI 50	
115 2 19	157 Kg	GS 100	
115 2 29	181 Kg	GI 100	12x 115 C75
115 2 39	229 Kg	GI 200	

SERIE 115 4 STANDARD



		cajones/tiroirs/drawers	
115 4 01	120 Kg	GI 50	
115 4 11	145 Kg	GS 80	1x 115 C100
115 4 31	189 Kg	GI 200	6x 115 C200
115 4 21	160 Kg	GI 80	4x 115 C100 2x 115 C200 2x 115 C250

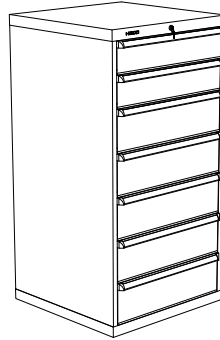

		cajones/tiroirs/drawers	
115 4 02	121 Kg	GI 50	
115 4 12	146 Kg	GS 80	2x 115 C150
115 4 32	186 Kg	GI 200	5x 115 C200
115 4 22	165 Kg	GI 80	1x 115 C75 2x 115 C100 1x 115 C125 2x 115 C200 2x 115 C250

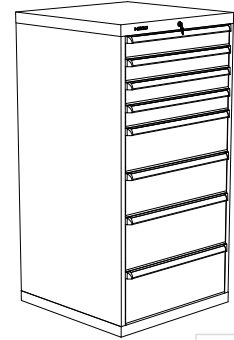

		cajones/tiroirs/drawers	
115 4 03	124 Kg	GI 50	
115 4 13	152 Kg	GS 80	4x 115 C100 2x 115 C200
115 4 33	201 Kg	GI 200	2x 115 C250
115 4 23	184 Kg	GI 80	2x 115 C50 1x 115 C75 1x 115 C100 1x 115 C125 2x 115 C150 3x 115 C200



		cajones/tiroirs/drawers	
115 4 04	102 Kg	GI 50	1x 115 C75
115 4 14	145 Kg	GS 80	2x 115 C100
115 4 34	200 Kg	GI 200	1x 115 C125 2x 115 C200 2x 115 C250
115 4 24	185Kg	GI 80	2x 115 C75 3x 115 C100 2x 115 C125 1x 115 C150 1x 115 C200 1x 115 C250

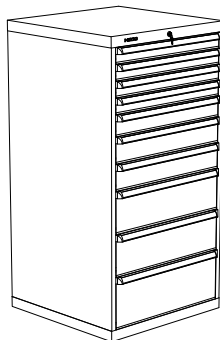

		cajones/tiroirs/drawers	
115 4 05	132 Kg	GI 50	4x 115 C75
115 4 15	165 Kg	GS 80	1x 115 C100 2x 115 C125
115 4 35	226 Kg	GI 200	2x 115 C200 1x 115 C250
115 4 25	192,5 Kg	GI 80	2x 115 C50 3x 115 C75 1x 115 C125 3x 115 C150 2x 115 C200

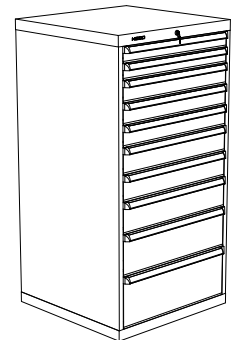

		cajones/tiroirs/drawers	
115 4 06	134 Kg	GI 50	2x 115 C75
115 4 16	167 Kg	GS 80	3x 115 C100 2x 115 C125
115 4 36	226 Kg	GI 200	1x 115 C150 1x 115 C200 1x 115 C250
115 4 26	189,5 Kg	GI 80	8x 115 C75 1x 115 C200 2x 115 C250

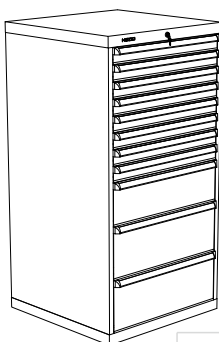

		cajones/tiroirs/drawers	
115 4 07	135 Kg	GI 50	8x 115 C75
115 4 17	169 Kg	GS 80	1x 115 C200
115 4 37	237 Kg	GI 200	2x 115 C250
115 4 27	202 Kg	GI 80	4x 115 C50 2x 115 C75 2x 115 C100 2x 115 C150 1x 115 C200 1x 115 C250

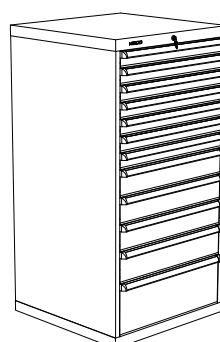

		cajones/tiroirs/drawers	
115 4 08	140 Kg	GI 50	
115 4 18	179 Kg	GS 80	7x 115 C75
115 4 28	195 Kg	GI 80	3x 115 C125
115 4 38	251 Kg	GI 200	1x 115 C150 1x 115 C250

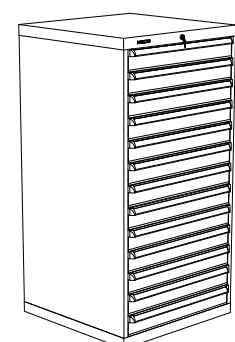

		cajones/tiroirs/drawers	
115 4 09	147 Kg	GI 50	
115 4 19	193 Kg	GS 80	
115 4 29	218,5 Kg	GI 80	13x 115 C100
115 4 39	264 Kg	GI 200	

## SERIE 119

ref. 119 1 / 119 2 / 119 4

Sistema antivuelco.  
Système anti-renversement.  
Anti-roll system.



Cierre centralizado.  
Verrouillage centralisé.  
Central locking.



SERIE 119 4



SERIE 119 2



SERIE 119 1

Guías simples o telescópicas.  
Glissières simples ou télescopiques.  
Simple or telescopic slides.

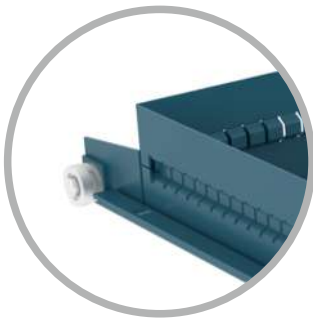

**GS**

Apertura 90%.  
Ouverture 90%.  
90% opening.

**GT**

Apertura 100%.  
Ouverture 100%.  
100% opening.

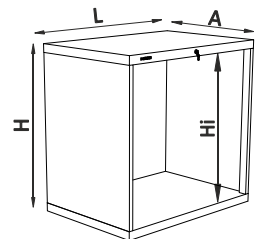
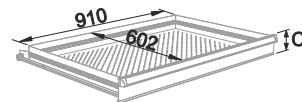

			LxAxH (mm)	Hi (mm)
119 1	54 Kg	1020x707x700	600	
119 2	62 Kg	1020x707x1000	900	
119 4	70 Kg	1020x707x1400	1300	

**e** 1 mm

SERIE 119	C	GS 100		GT 100		GT 200		GT 200		PORTACONOS PORTE-CÔNES TOOL HOLDER	
		Model	Weight	Model	Weight	Model	Weight	Model	Weight		
	C=50	●		●	119 T100 C50	15,5Kg	●	119 T200 C75	21,5Kg		
	C=75	●		●	119 T100 C75	16,5Kg	●	119 T200 C100	22,5Kg	119 T200 ISO 40	
	C=100	●	119 S100 C100	15Kg	●	119 T100 C100	17,5Kg	●	119 T200 C125	23,5Kg	119 T200 HSK 50
	C=125	●	119 S100 C125	15,5Kg	●	119 T100 C125	18,5Kg	●	119 T200 C150	24,5Kg	119 T200 HSK 63
	C=150	●	119 S100 C150	16Kg	●	119 T100 C150	19Kg	●	119 T200 C200	25,5Kg	119 T200 HSK 80
	C=200	●	119 S100 C200	18Kg	●	119 T100 C200	20Kg	●	119 T200 C250	27Kg	119 T200 ISO 50
	C=250	●	119 S100 C250	19,5Kg	●	119 T100 C250	22,5Kg	●			119 T200 HSK 100
	C=300										
											33Kg
											31Kg

**e** 1.5 mm

**e** 1.5 mm

**e** 1.5 mm

**e** 1.5 mm

**i** ACCESORIOS. Ver información (PAG. 289).  
ACCESOIRES. Voir information (PAG. 289).  
ACCESORIES. See information (PAG. 289).

**i** Los cajones no incluyen divisiones.  
Les tiroirs n'incluent pas les séparations.  
Divisions for drawers not included.

SERIE 119 1 STANDARD

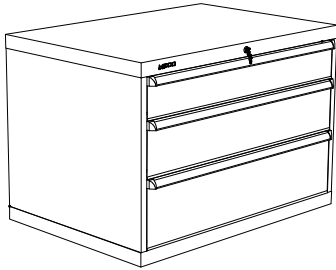

cajones/tiroirs/drawers

119 1 11	108 Kg	GS	100	1x 119 C150
119 1 21	115,5 Kg	GI	100	1x 119 C200
119 1 31	131 Kg	GI	200	1x 119 C250

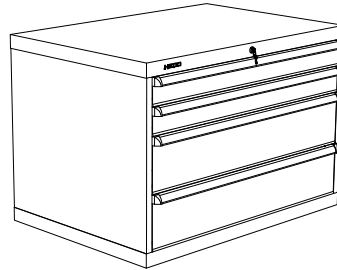

cajones/tiroirs/drawers

119 1 12	120 Kg	GS	100	2x 119 C100
119 1 22	129 Kg	GI	100	2x 119 C200
119 1 32	150 Kg	GI	200	2x 119 C250



cajones/tiroirs/drawers

119 1 13	118 Kg	GS	100	4x 119 C150
119 1 23	130 Kg	GI	100	4x 119 C150
119 1 33	152 Kg	GI	200	4x 119 C150

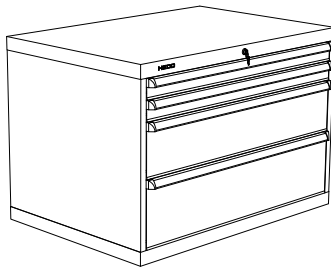

cajones/tiroirs/drawers

119 1 14	118 Kg	GS	100	2x 119 C75
119 1 34	150 Kg	GI	200	1x 119 C200
119 1 24	129,5 Kg	GI	100	1x 119 C250
				1x 119 C50
				1x 119 C100
				1x 119 C200
				1x 119 C250

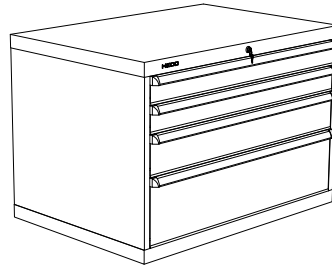

cajones/tiroirs/drawers

119 1 15	120 Kg	GS	100	2x 119 C100
119 1 35	151 Kg	GI	200	1x 119 C150
119 1 25	144 Kg	GI	100	1x 119 C250
				1x 119 C50
				2x 119 C75
				1x 119 C150
				1x 119 C250

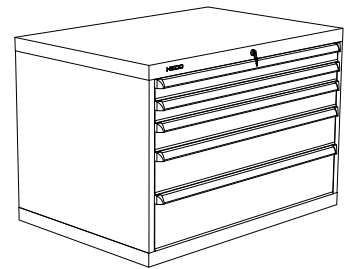

cajones/tiroirs/drawers

119 1 16	129 Kg	GS	100	2x 119 C75
119 1 36	170 Kg	GI	200	1x 119 C100
119 1 26	143,5 Kg	GI	100	1x 119 C150
				1x 119 C200

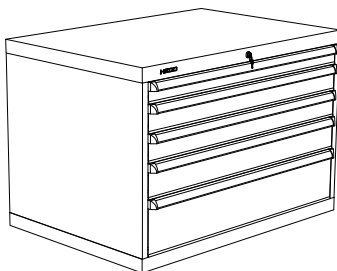

cajones/tiroirs/drawers

119 1 17	131 Kg	GS	100	1x 119 C75
119 1 27	144 Kg	GI	100	2x 119 C100
119 1 37	170 Kg	GI	200	1x 119 C125
				1x 119 C200

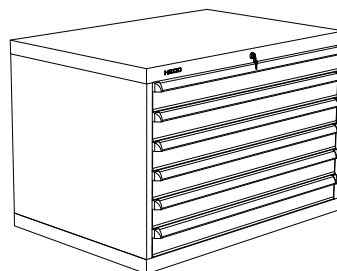

cajones/tiroirs/drawers

119 1 18	144 Kg	GS	100	6x 119 C100
119 1 28	159 Kg	GI	100	6x 119 C100
119 1 38	189 Kg	GI	200	6x 119 C100

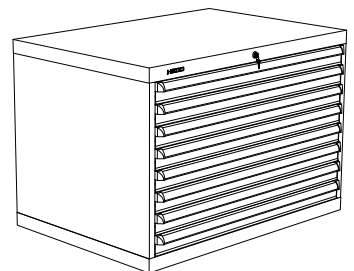

cajones/tiroirs/drawers

119 1 19	158 Kg	GS	100	8x 119 C75
119 1 29	186 Kg	GI	100	8x 119 C75
119 1 39	226 Kg	GI	200	8x 119 C75

SERIE 119 2 STANDARD

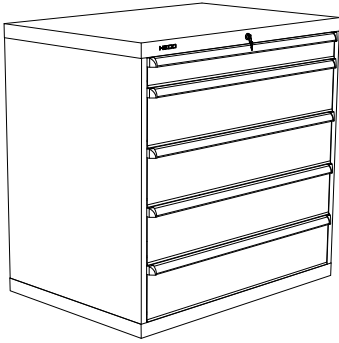

cajones/tiroirs/drawers			
119 2 11	149 Kg	GS 100	1x 119 C100
119 2 31	187 Kg	GI 200	4x 119 C200
119 2 21	173,5 Kg	GI 100	1x 119 C75 1x 119 C100 1x 119 C125 1x 119 C150 1x 119 C200 1x 119 C250

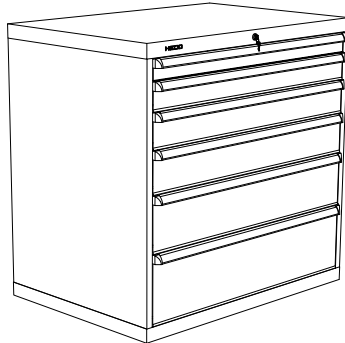

cajones/tiroirs/drawers			
119 2 12	159 Kg	GS 100	1x 119 C75 1x 119 C100 1x 119 C125 1x 119 C150 1x 119 C200 1x 119 C250
119 2 32	205 Kg	GI 200	6x 119 C150
119 2 22	176 Kg	GI 100	6x 119 C150

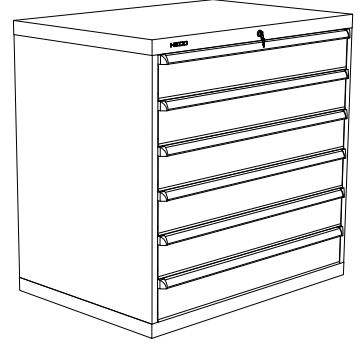

cajones/tiroirs/drawers			
119 2 13	158 Kg	GS 100	6x 119 C150
119 2 33	209 Kg	GI 200	3x 119 C75 1x 119 C100 1x 119 C125 1x 119 C200 1x 119 C250
119 2 23	190 Kg	GI 100	3x 119 C75 1x 119 C100 1x 119 C125 1x 119 C200 1x 119 C250

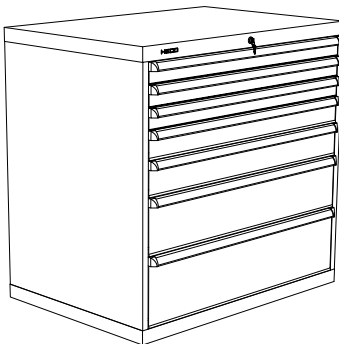

cajones/tiroirs/drawers			
119 2 14	168 Kg	GS 100	3x 119 C75 1x 119 C100 1x 119 C125
119 2 34	225 Kg	GI 200	1x 119 C200 1x 119 C250
119 2 24	203 Kg	GI 100	2x 119 C50 1x 119 C75 2x 119 C100 1x 119 C125 2x 119 C200

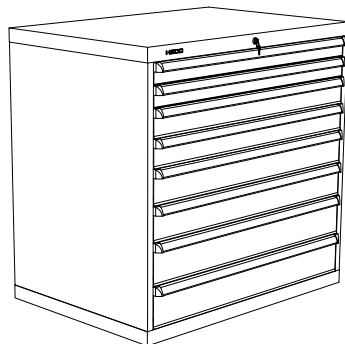

cajones/tiroirs/drawers			
119 2 15	181 Kg	GS 100	2x 119 C75 2x 119 C100 2x 119 C125 2x 119 C150
119 2 35	246 Kg	GI 200	2x 119 C50 2x 119 C75 2x 119 C100 2x 119 C125 1x 119 C200
119 2 25	218 Kg	GI 100	2x 119 C50 2x 119 C75 2x 119 C100 2x 119 C125 1x 119 C200

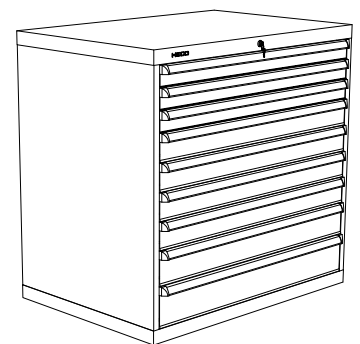

cajones/tiroirs/drawers			
119 2 16	193 Kg	GS 100	3x 119 C75 4x 119 C100 1x 119 C125 1x 119 C150
119 2 26	219 Kg	GI 100	3x 119 C75 4x 119 C100 1x 119 C125 1x 119 C150
119 2 36	265 Kg	GI 200	3x 119 C75 4x 119 C100 1x 119 C125 1x 119 C150

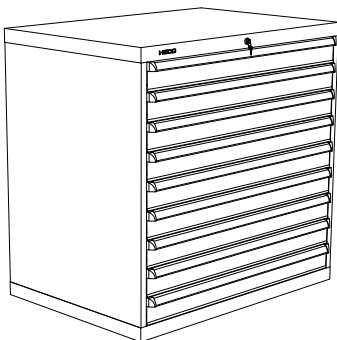

cajones/tiroirs/drawers			
119 2 17	197 Kg	GS 100	9x 119 C100
119 2 27	219,5 Kg	GI 100	9x 119 C100
119 2 37	247 Kg	GI 200	9x 119 C100

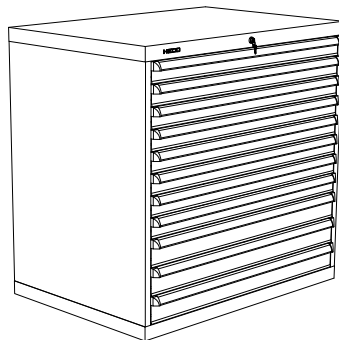

cajones/tiroirs/drawers			
119 2 18	211 Kg	GS 100	8x 119 C75 3x 119 C100
119 2 38	302 Kg	GI 200	3x 119 C50 6x 119 C75 3x 119 C100
119 2 28	260 Kg	GI 100	3x 119 C50 6x 119 C75 3x 119 C100

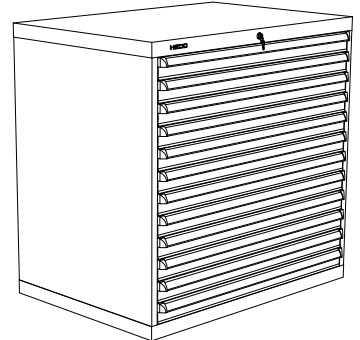

cajones/tiroirs/drawers			
119 2 19	218 Kg	GS 100	12x 119 C75
119 2 29	260 Kg	GI 100	12x 119 C75
119 2 39	320 Kg	GI 200	12x 119 C75



SERIE 119 4 STANDARD

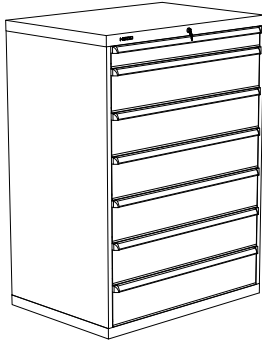

cajones/tiroirs/drawers			
119 4 11	193 Kg	GS 100	1x 119 C100
119 4 31	246Kg	GI 200	6x 119 C200
119 4 21	230 Kg	GI 100	4x 119 C100 2x 119 C200 2x 119 C250

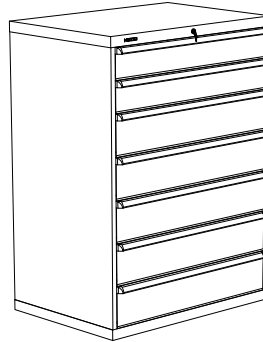

cajones/tiroirs/drawers			
119 4 12	182 Kg	GS 100	2x 119 C150
119 4 32	247 Kg	GI 200	5x 119 C200
119 4 22	230 Kg	GI 100	1x 119 C75 2x 119 C100 1x 119 C125 2x 119 C200 2x 119 C250



cajones/tiroirs/drawers			
119 4 13	205 Kg	GS 100	4x 119 C100 2x 119 C200
119 4 33	265 Kg	GI 200	2x 119 C250
119 4 23	251,5 Kg	GI 100	2x 119 C50 1x 119 C75 1x 119 C100 1x 119 C125 2x 119 C150 3x 119 C200

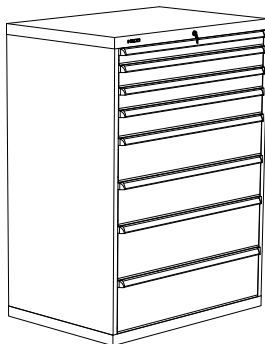

cajones/tiroirs/drawers			
119 4 14	204 Kg	GS 100	1x 119 C75 2x 119 C100 1x 119 C125
119 4 34	265 Kg	GI 200	2x 119 C200 2x 119 C250
119 4 24	254Kg	GI 100	2x 119 C75 3x 119 C100 2x 119 C125 1x 119 C150 1x 119 C200 1x 119 C250

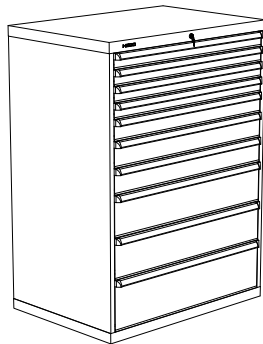

cajones/tiroirs/drawers			
119 4 15	224 Kg	GS 100	4x 119 C75 1x 119 C100 2x 119 C125 2x 119 C200
119 4 35	304 Kg	GI 200	1x 119 C250
119 4 25	266 Kg	GI 100	2x 119 C50 3x 119 C75 1x 119 C125 3x 119 C150 2x 119 C200

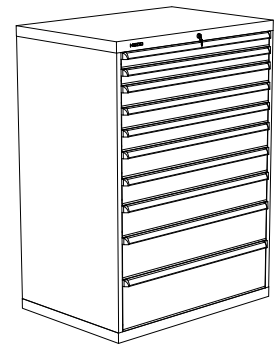

cajones/tiroirs/drawers			
119 4 16	226 Kg	GS 100	2x 119 C75 3x 119 C100 2x 119 C125 1x 119 C150
119 4 36	305 Kg	GI 200	1x 119 C200 1x 119 C250
119 4 26	272 Kg	GI 100	8x 119 C75 1x 119 C200 2x 119 C250

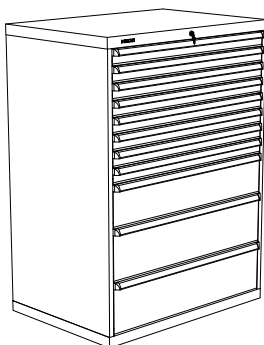

cajones/tiroirs/drawers			
119 4 17	231 Kg	GS 100	8x 119 C75 1x 119 C200
119 4 37	322 Kg	GI 200	2x 119 C250
119 4 27	280,5 Kg	GI 100	4x 119 C50 2x 119 C75 2x 119 C100 2x 119 C150 1x 119 C200 1x 119 C250

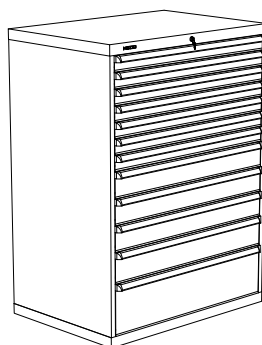

cajones/tiroirs/drawers			
119 4 18	243 Kg	GS 100	7x 119 C75
119 4 28	282,5 Kg	GI 100	3x 119 C125 1x 119 C150
119 4 38	343 Kg	GI 200	1x 119 C250

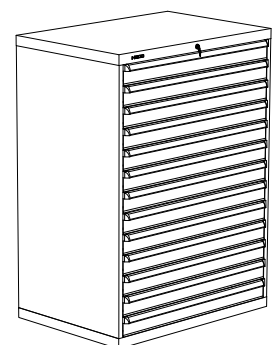

cajones/tiroirs/drawers			
119 4 19	265 Kg	GS 100	
119 4 29	297,5 Kg	GI 100	13x 119 C100
119 4 39	363 Kg	GI 200	

## SERIE 143

ref. 143 1 / 143 2 / 143 4

**new**

Sistema antivuelco.  
Système anti-renversement.  
Anti-roll system.



Cierre centralizado.  
Verrouillage centralisé.  
Central locking.



SERIE 143 4

SERIE 143 2

SERIE 143 1

Guías telescópicas.  
Glissières télescopiques.  
Telescopic slides.

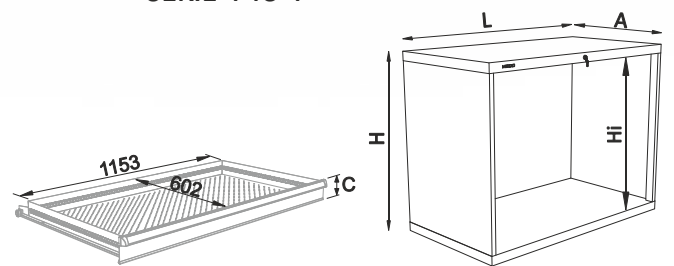

**GT** Apertura 100%.  
Ouverture 100%.  
100% opening.

		LxAxH (mm)	Hi (mm)
143 1	68,8 Kg	1300x707x700	600
143 2	79 Kg	1300x707x1000	900
143 4	87,2Kg	1300x707x1400	1300

**e** 1 mm

**i** Los cajones no incluyen divisiones.  
Les tiroirs n'incluent pas les séparations.  
Divisions for drawers no included.

**i** ACCESORIOS. Ver información (PAG. 289).  
ACCESOIRES. Voir information (PAG. 289).  
ACCESSORIES. See information (PAG. 289).

		<b>GT 200</b>	
SERIE 143	C=75	●	143 T200 C75 27,4Kg
	C=100	●	143 T200 C100 28,7Kg
	C=125	●	143 T200 C125 30Kg
	C=150	●	143 T200 C150 31,2Kg
	C=200	●	143 T200 C200 32,5Kg
C=250	●	143 T200 C250 34,4Kg	
		<b>e</b>	1.5 mm

SERIE 143 1 STANDARD

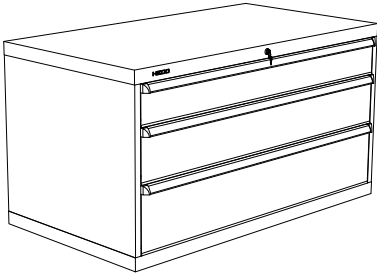

143 1 31	170 Kg		cajones/tiroirs/drawers
			1x 143 C150 1x 143 C200 1x 143 C250

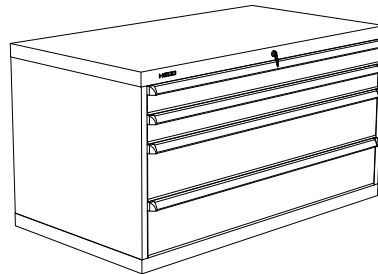

143 1 32	195 Kg		cajones/tiroirs/drawers
			2x 143 C100 2x 143 C200

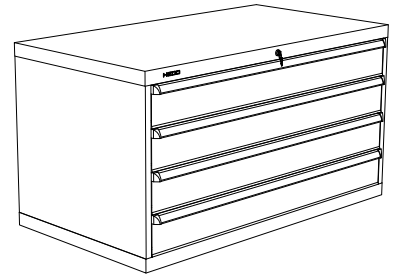

143 1 33	198 Kg		cajones/tiroirs/drawers
			4x 143 C150

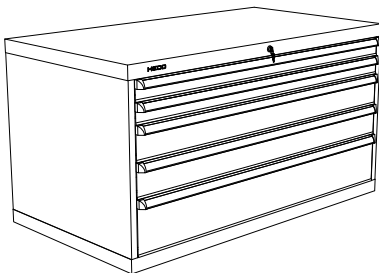

143 1 34	195 Kg		cajones/tiroirs/drawers
			2x 143 C75 1x 143 C200 1x 143 C250

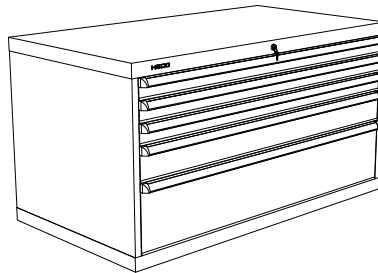

143 1 35	196 Kg		cajones/tiroirs/drawers
			2x 143 C100 1x 143 C150 1x 143 C250

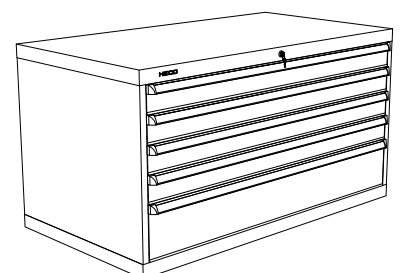

143 1 36	221 Kg		cajones/tiroirs/drawers
			2x 143 C75 1x 143 C100 1x 143 C150 1x 143 C200

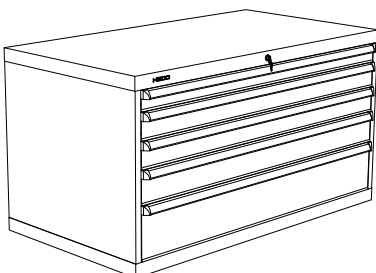

143 1 37	221 Kg		cajones/tiroirs/drawers
			1x 143 C75 2x 143 C100 1x 143 C125 1x 143 C200

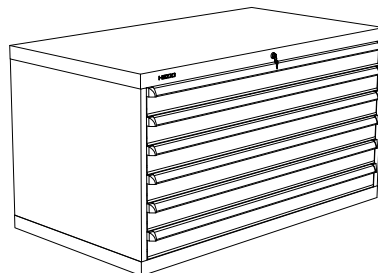

143 1 38	246 Kg		cajones/tiroirs/drawers
			6x 143 C100

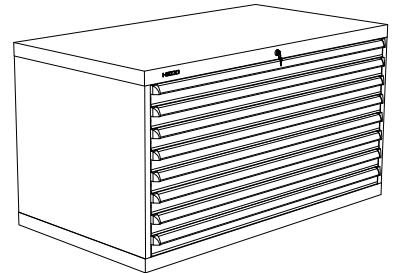

143 1 39	294 Kg		cajones/tiroirs/drawers
			8x 143 C75

SERIE 143 2 STANDARD

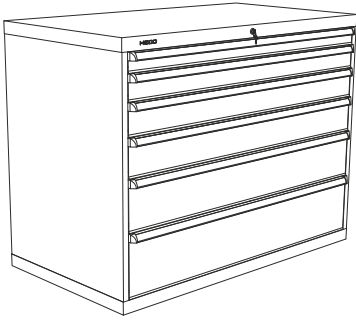

143 2 31	243 Kg		cajones/tiroirs/drawers
			1x 143 C100 4x 143 C200

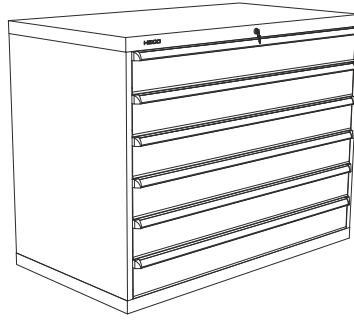

143 2 32	266 Kg		cajones/tiroirs/drawers
			1x 143 C75 1x 143 C100 1x 143 C125 1x 143 C150 1x 143 C200 1x 143 C250

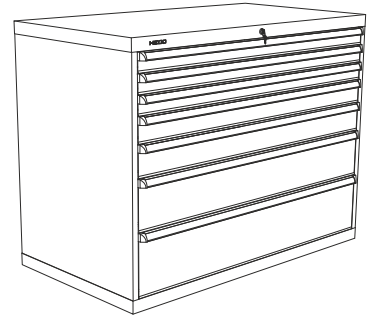

143 2 33	272 Kg		cajones/tiroirs/drawers
			6x 143 C150

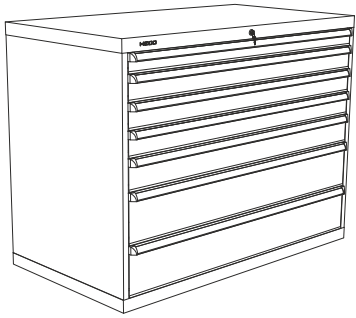

143 2 34	293 Kg		cajones/tiroirs/drawers
			3x 143 C75 1x 143 C100 1x 143 C125 1x 143 C200 1x 143 C250

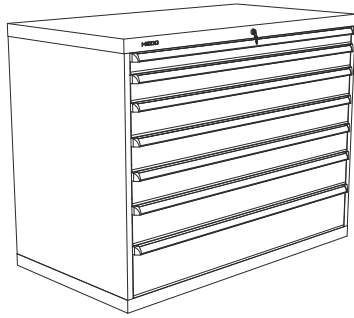

143 2 35	320 Kg		cajones/tiroirs/drawers
			2x 143 C75 2x 143 C100 2x 143 C125 2x 143 C150

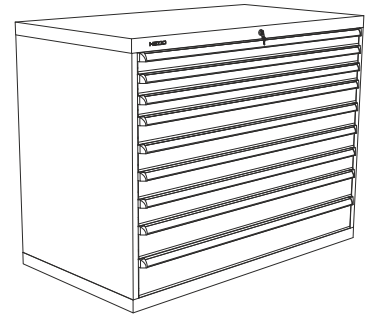

143 2 36	345 Kg		cajones/tiroirs/drawers
			3x 143 C75 4x 143 C100 1x 143 C125 1x 143 C150

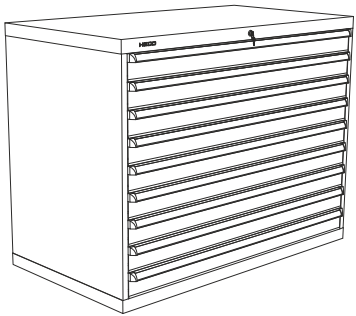

143 2 37	321 Kg		cajones/tiroirs/drawers
			9x 143 C100

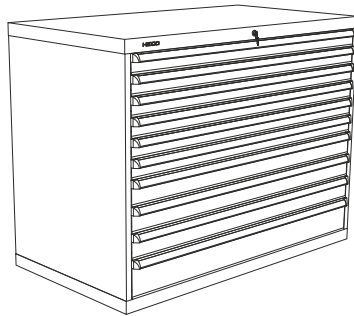

143 2 38	393 Kg		cajones/tiroirs/drawers
			8x 143 C75 3x 143 C100

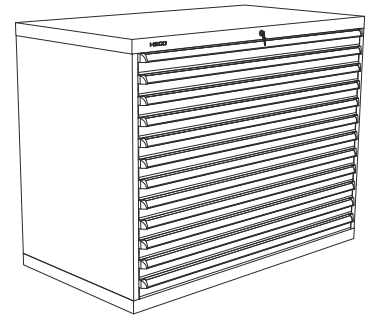

143 2 39	416 Kg		cajones/tiroirs/drawers
			12x 143 C75

SERIE 143 4 STANDARD



		cajones/tiroirs/drawers	
143 4 31	320 Kg		1x 143 C100 6x 143 C200



		cajones/tiroirs/drawers	
143 4 32	322 Kg		2x 143 C150 5x 143 C200



		cajones/tiroirs/drawers	
143 4 33	345 Kg		4x 143 C100 2x 143 C200 2x 143 C250

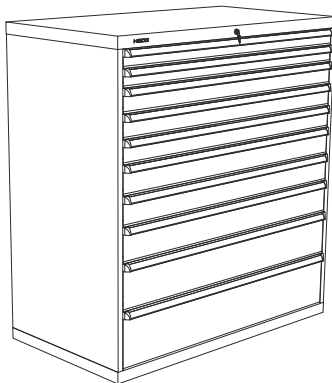

		cajones/tiroirs/drawers	
143 4 34	345 Kg		1x 143 C75 2x 143 C100 1x 143 C125 2x 143 C200 2x 143 C250

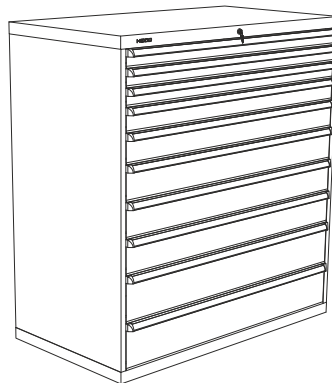

		cajones/tiroirs/drawers	
143 4 35	395 Kg		4x 143 C75 1x 143 C100 2x 143 C125 2x 143 C200 1x 143 C250

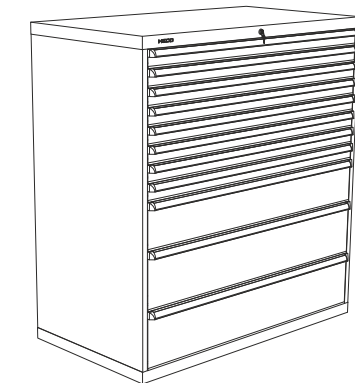

		cajones/tiroirs/drawers	
143 4 36	397 Kg		2x 143 C75 3x 143 C100 2x 143 C125 1x 143 C150 1x 143 C200 1x 143 C250

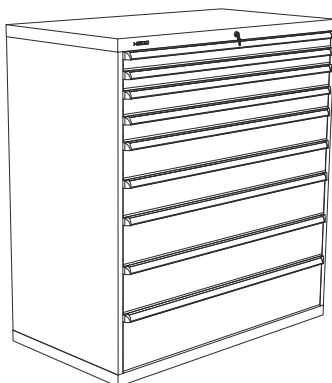

		cajones/tiroirs/drawers	
143 4 37	419 Kg		8x 143 C75 1x 143 C200 2x 143 C250

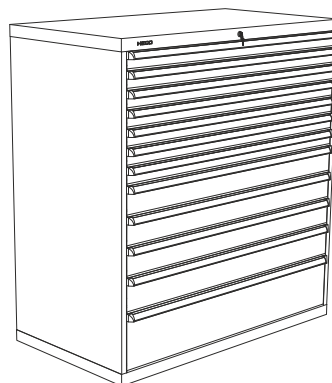

		cajones/tiroirs/drawers	
143 4 38	446 Kg		7x 143 C75 3x 143 C125 1x 143 C150 1x 143 C250

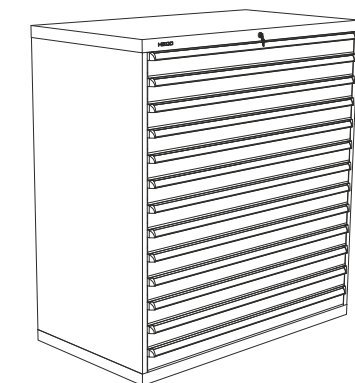

		cajones/tiroirs/drawers	
143 4 39	472 Kg		13x 143 C100

## SERIE 122

ref. 122 1 / 122 2 / 122 4

Sistema antivuelco.  
Système anti-renversement.  
Anti-roll system.



Cierre centralizado.  
Verrouillage centralisé.  
Central locking.

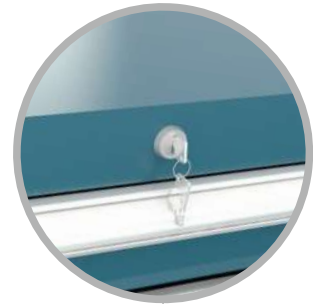

SERIE 122 4



SERIE 122 2



SERIE 122 1

Guías simples.  
Glissières simples.  
Simple slides.

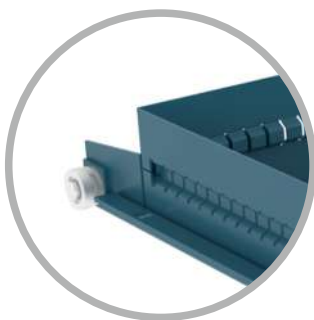

**GS** Apertura 90%.  
Ouverture 90%.  
90% opening.

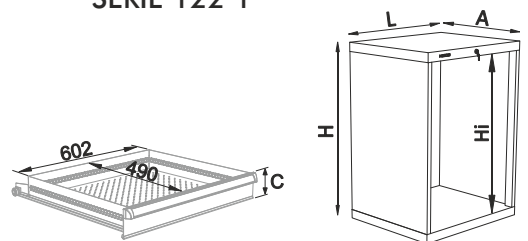

		LxAxH (mm)	Hi (mm)
122 1	24,5 Kg	714x600x700	600
122 2	31 Kg	714x600x1000	900
122 4	40 Kg	714x600x1400	1300

**e** 1 mm

**i** Los cajones no incluyen divisiones.  
Les tiroirs n'incluent pas les séparations.  
Divisions for drawers no included.



**i** ACCESORIOS. Ver información (PAG. 289).  
ACCESOIRES. Voir information (PAG. 289).  
ACCESSORIES. See information (PAG. 289).

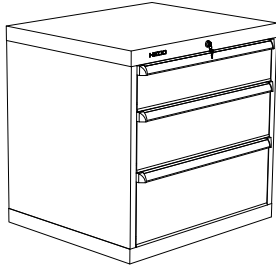

		<b>GS</b>	<b>100</b>	
SERIE 122	C=75	●	●	122 S100 C75 7,5Kg
	C=100	●	●	122 S100 C100 8Kg
	C=125	●	●	122 S100 C125 8,5Kg
	C=150	●	●	122 S100 C150 9Kg
	C=200	●	●	122 S100 C200 10Kg
	C=250	●	●	122 S100 C250 11Kg
		<b>e</b> 1.2 mm		

SERIE 122 1 STANDARD



122 1 11	54,5 Kg	 	cajones/tiroirs/drawers
			1x 122 C150 1x 122 C200 1x 122 C250

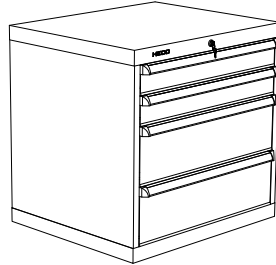

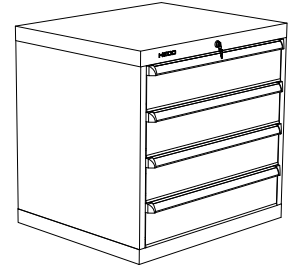

122 1 12	60,5 Kg	 	cajones/tiroirs/drawers
			2x 122 C100 2x 122 C200



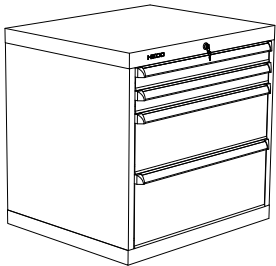

122 1 13	60,5 Kg	 	cajones/tiroirs/drawers
			4x 122 C150



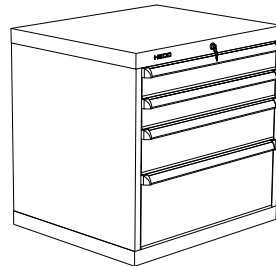

122 1 14	60,5 Kg	 	cajones/tiroirs/drawers
			2x 122 C75 1x 122 C200 1x 122 C250



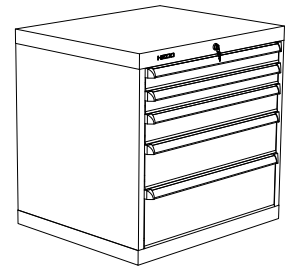

122 1 15	60,5 Kg	 	cajones/tiroirs/drawers
			2x 122 C100 1x 122 C150 1x 122 C250



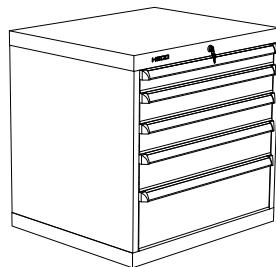

122 1 16	66,5 Kg	 	cajones/tiroirs/drawers
			2x 122 C75 1x 122 C100 1x 122 C150 1x 122 C200

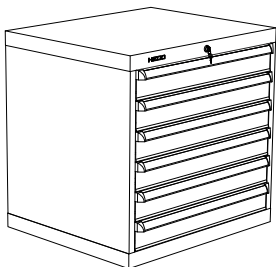

122 1 17	66,5 Kg	 	cajones/tiroirs/drawers
			1x 122 C75 2x 122 C100 1x 122 C125 1x 122 C200



122 1 18	72,5 Kg	 	cajones/tiroirs/drawers
			6x 122 C100

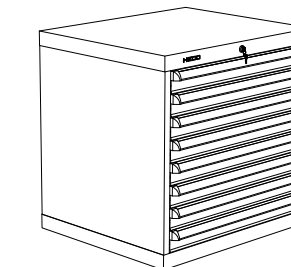

122 1 19	84,5 Kg	 	cajones/tiroirs/drawers
			8x 122 C75

SERIE 122 2 STANDARD



122 2 11	84,5 Kg			cajones/tiroirs/drawers
				1x 122 C100 4x 122 C200

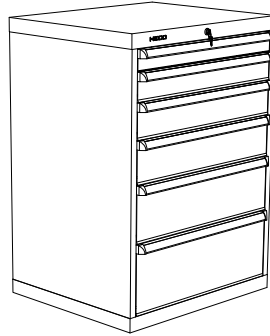

122 2 12	91 Kg			cajones/tiroirs/drawers
				1x 122 C75 1x 122 C100 1x 122 C125 1x 122 C150 1x 122 C200 1x 122 C250



122 2 13	91 Kg			cajones/tiroirs/drawers
				6x 122 C150

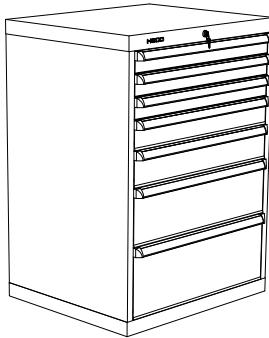

122 2 14	97 Kg			cajones/tiroirs/drawers
				3x 122 C75 1x 122 C100 1x 122 C125 1x 122 C200 1x 122 C250

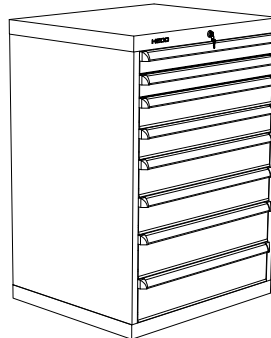

122 2 15	103 Kg			cajones/tiroirs/drawers
				2x 122 C75 2x 122 C100 2x 122 C125 2x 122 C150



122 2 16	103 Kg			cajones/tiroirs/drawers
				3x 122 C75 4x 122 C100 1x 122 C125 1x 122 C150

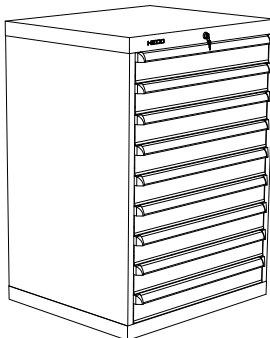

122 2 17	109 Kg			cajones/tiroirs/drawers
				9x 122 C100

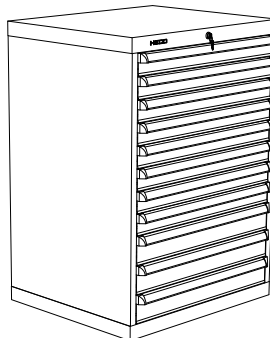

122 2 18	121 Kg			cajones/tiroirs/drawers
				8x 122 C75 3x 122 C100

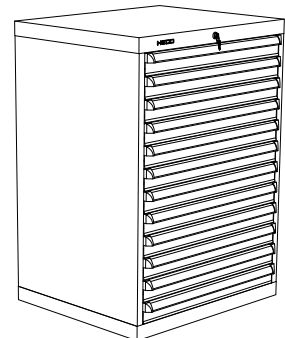

122 2 19	127 Kg			cajones/tiroirs/drawers
				12x 122 C75



SERIE 122 4 STANDARD

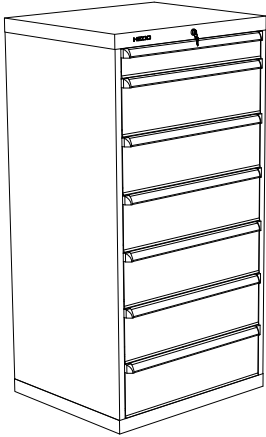

122 4 11	114 Kg	 	cajones/tiroirs/drawers 1x 122 C100 6x 122 C200
----------	--------	---	---

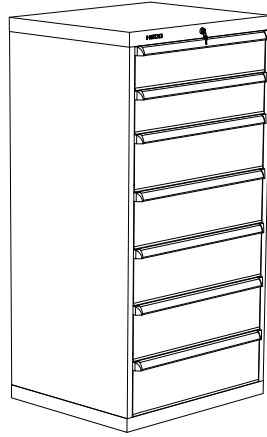

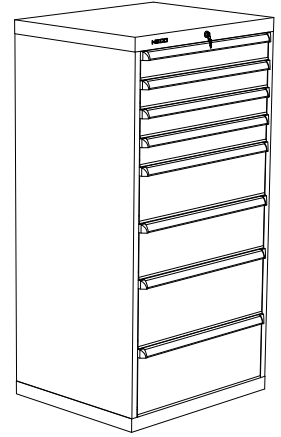

122 4 12	114 Kg	 	cajones/tiroirs/drawers 2x 122 C150 5x 122 C200
----------	--------	---	---



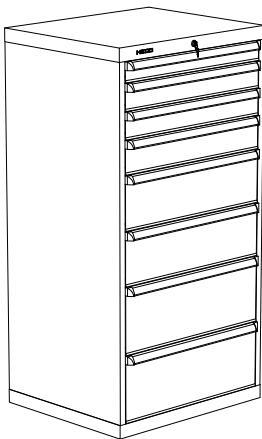

122 4 13	120 Kg	 	cajones/tiroirs/drawers 4x 122 C100 2x 122 C200 2x 122 C250
----------	--------	---	--



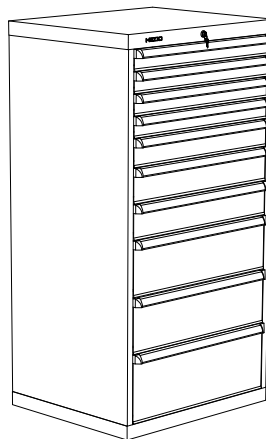

122 4 14	121 Kg	 	cajones/tiroirs/drawers 1x 122 C75 2x 122 C100 1x 122 C125 2x 122 C200 2x 122 C250
----------	--------	---	---



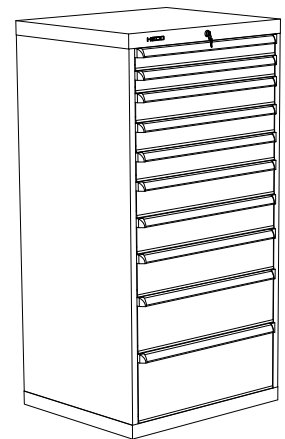

122 4 15	132,5 Kg	 	cajones/tiroirs/drawers 4x 122 C75 1x 122 C100 2x 122 C125 2x 122 C200 1x 122 C250
----------	----------	---	---



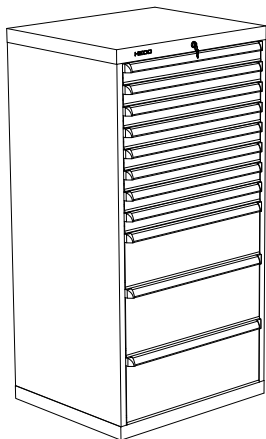

122 4 16	126 Kg	 	cajones/tiroirs/drawers 2x 122 C75 3x 122 C100 2x 122 C125 1x 122 C150 1x 122 C200 1x 122 C250
----------	--------	---	--



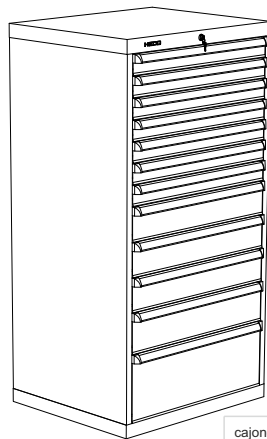

122 4 17	138 Kg	 	cajones/tiroirs/drawers 8x 122 C75 1x 122 C200 2x 122 C250
----------	--------	---	---

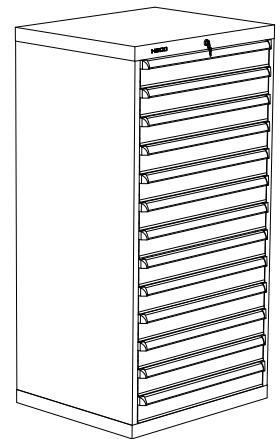

122 4 18	144 Kg	 	cajones/tiroirs/drawers 7x 122 C75 3x 122 C125 1x 122 C150 1x 122 C250
----------	--------	---	--



122 4 19	150 Kg	 	cajones/tiroirs/drawers 13x 122 C100
----------	--------	---	---

**SERIE 123**

ref. 123 1 / 123 2 / 123 4

Sistema antivuelco.  
Système anti-renversement.  
Anti-roll system.



Cierre centralizado.  
Verrouillage centralisé.  
Central locking.

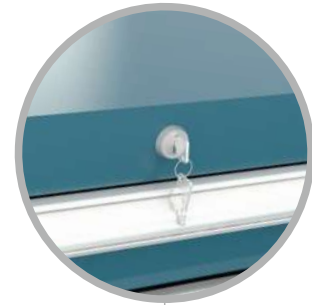

SERIE 123 4

SERIE 123 2

SERIE 123 1

Guías simples.  
Glissières simples.  
Simple slides.

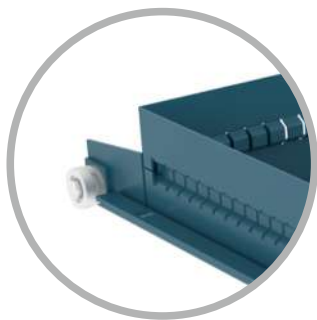

**GS** Apertura 90%.  
Ouverture 90%.  
90% opening.

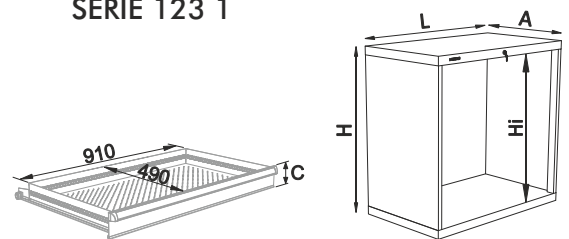

		LxAxH (mm)	Hi (mm)
123 1	48 Kg	1020x600x700	600
123 2	54 Kg	1020x600x1000	900
123 4	62 Kg	1020x600x1400	1300

**e** 1 mm



**i** Los cajones no incluyen divisiones.  
Les tiroirs n'incluent pas les séparations.  
Divisions for drawers no included.

**i** ACCESORIOS. Ver información (PAG. 289).  
ACCESOIRES. Voir information (PAG. 289).  
ACCESSORIES. See information (PAG. 289).

		<b>GS</b>	<b>100</b>		
SERIE 123	C=75	●	●	123 S100 C75	9,5Kg
	C=100	●	●	123 S100 C100	10,5Kg
	C=125	●	●	123 S100 C125	11Kg
	C=150	●	●	123 S100 C150	11,5Kg
	C=200	●	●	123 S100 C200	13Kg
	C=250	●	●	123 S100 C250	14,5Kg
		<b>e</b>		1.2 mm	

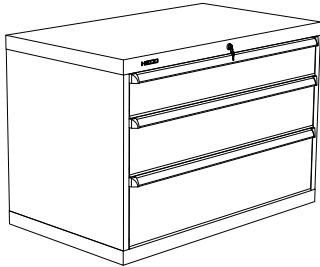
SERIE 123 1 STANDARD



123 1 11	87 Kg	 	cajones/tiroirs/drawers
			1x 123 C150 1x 123 C200 1x 123 C250

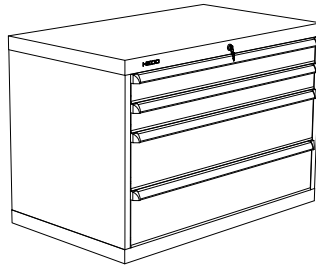

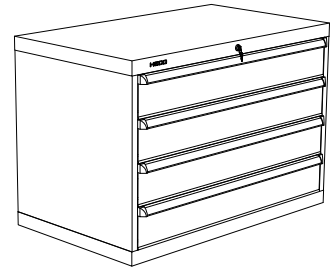

123 1 12	95 Kg	 	cajones/tiroirs/drawers
			2x 123 C100 2x 123 C200



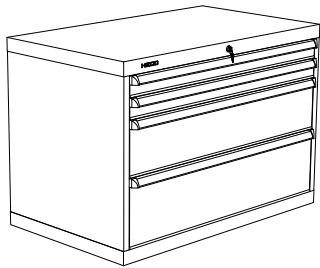

123 1 13	94 Kg	 	cajones/tiroirs/drawers
			4x 123 C150



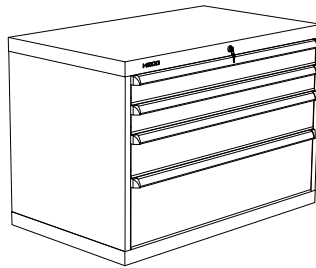

123 1 14	94,5 Kg	 	cajones/tiroirs/drawers
			2x 123 C75 1x 123 C200 1x 123 C250



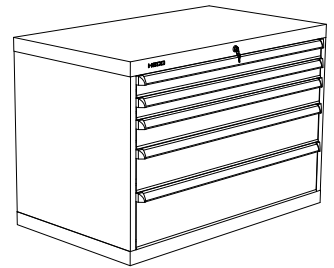

123 1 15	95 Kg	 	cajones/tiroirs/drawers
			2x 123 C100 1x 123 C150 1x 123 C250



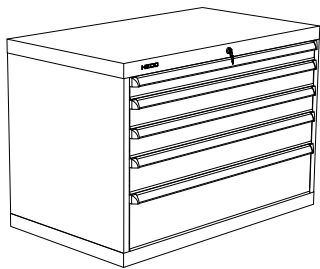

123 1 16	102 Kg	 	cajones/tiroirs/drawers
			2x 123 C75 1x 123 C100 1x 123 C150 1x 123 C200

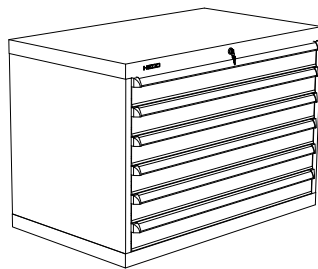

123 1 17	102,5 Kg	 	cajones/tiroirs/drawers
			1x 123 C75 2x 123 C100 1x 123 C125 1x 123 C200



123 1 18	111 Kg	 	cajones/tiroirs/drawers
			6x 123 C100

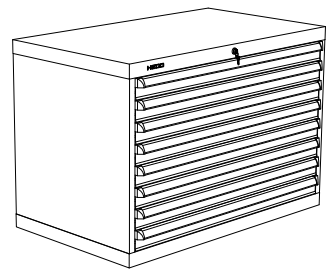

123 1 19	124 Kg	 	cajones/tiroirs/drawers
			8x 123 C75

SERIE 123 2 STANDARD



123 2 11	105,5 Kg			cajones/tiroirs/drawers 1x 123 C100 4x 123 C200
----------	----------	--	--	---



123 2 12	113 Kg			cajones/tiroirs/drawers 1x 123 C75 1x 123 C100 1x 123 C125 1x 123 C150 1x 123 C200 1x 123 C250
----------	--------	--	--	--



123 2 13	112 Kg			cajones/tiroirs/drawers 6x 123 C150
----------	--------	--	--	--

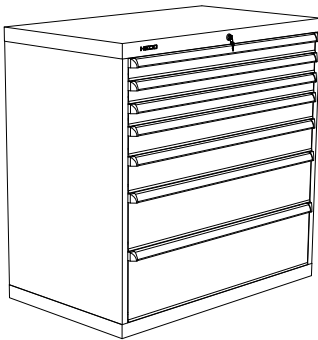

123 2 14	120,5 Kg			cajones/tiroirs/drawers 3x 123 C75 1x 123 C100 1x 123 C125 1x 123 C200 1x 123 C250
----------	----------	--	--	---

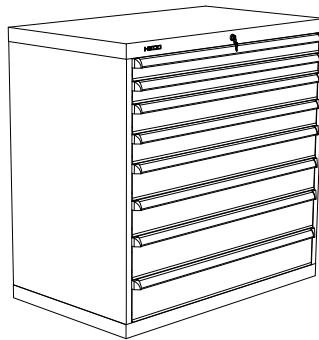

123 2 15	128 Kg			cajones/tiroirs/drawers 2x 123 C75 2x 123 C100 2x 123 C125 2x 123 C150
----------	--------	--	--	--

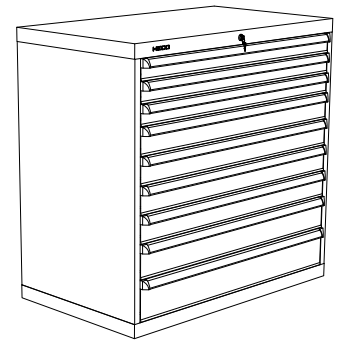

123 2 16	136 Kg			cajones/tiroirs/drawers 3x 123 C75 4x 123 C100 1x 123 C125 1x 123 C150
----------	--------	--	--	--

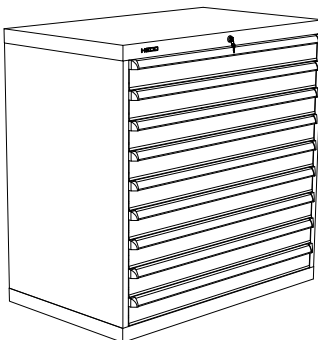

123 2 17	137,5 Kg			cajones/tiroirs/drawers 9x 123 C100
----------	----------	--	--	--

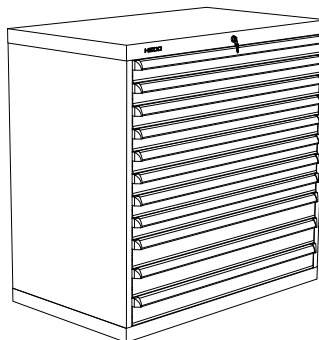

123 2 18	150,5 Kg			cajones/tiroirs/drawers 8x 123 C75 3x 123 C100
----------	----------	--	--	--

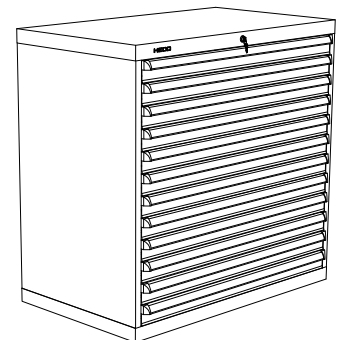

123 2 19	157 Kg			cajones/tiroirs/drawers 12x 123 C75
----------	--------	--	--	--

SERIE 123 4 STANDARD

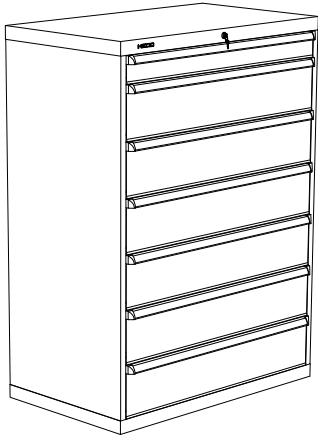

cajones/tiroirs/drawers

123 4 11	142,5 Kg	GS	100	1x 123 C100 6x 123 C200
----------	----------	----	-----	----------------------------

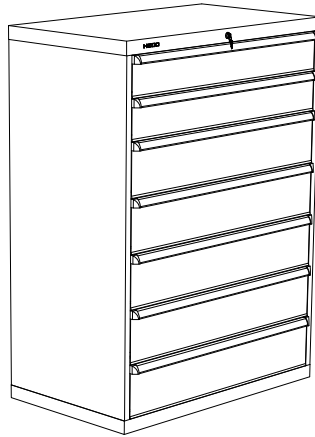

cajones/tiroirs/drawers

123 4 12	142 Kg	GS	100	2x 123 C150 5x 123 C200
----------	--------	----	-----	----------------------------



cajones/tiroirs/drawers

123 4 13	151 Kg	GS	100	4x 123 C100 2x 123 C200 2x 123 C250
----------	--------	----	-----	---

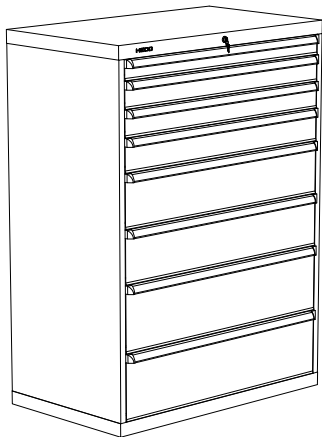

cajones/tiroirs/drawers

123 4 14	150,5 Kg	GS	100	1x 123 C75 2x 123 C100 1x 123 C125 2x 123 C200 2x 123 C250
----------	----------	----	-----	--

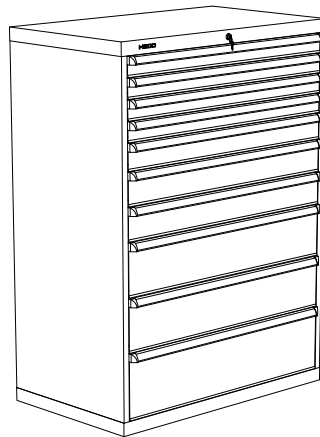

cajones/tiroirs/drawers

123 4 15	165 Kg	GS	100	4x 123 C75 1x 123 C100 2x 123 C125 2x 123 C200 1x 123 C250
----------	--------	----	-----	--

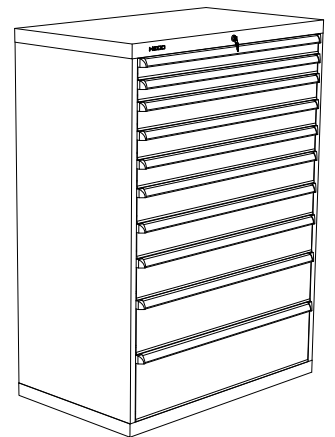

cajones/tiroirs/drawers

123 4 16	155 Kg	GS	100	2x 123 C75 3x 123 C100 2x 123 C125 1x 123 C150 1x 123 C200 1x 123 C250
----------	--------	----	-----	---

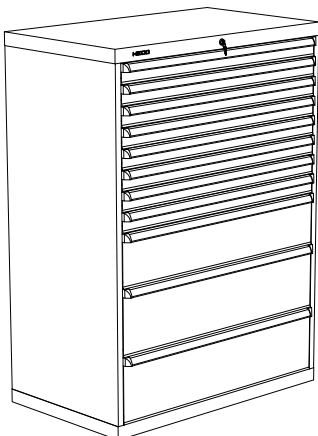

cajones/tiroirs/drawers

123 4 17	172 Kg	GS	100	8x 123 C75 1x 123 C200 2x 123 C250
----------	--------	----	-----	--

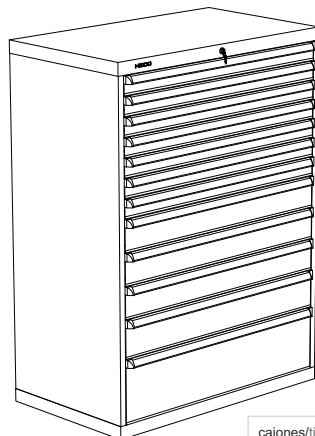

cajones/tiroirs/drawers

123 4 18	179,5 Kg	GS	100	7x 123 C75 3x 123 C125 1x 123 C150 1x 123 C250
----------	----------	----	-----	---

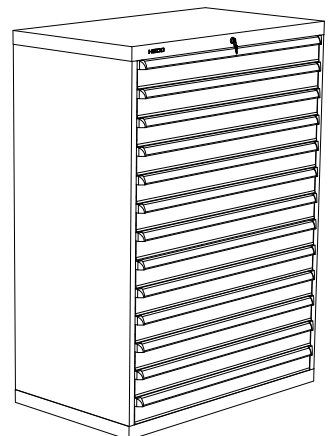

cajones/tiroirs/drawers

123 4 19	177,5 Kg	GS	100	13x 123 C100
----------	----------	----	-----	--------------

**SERIE 135**

ref. 135 1 / 135 2 / 135 4

Sistema antivuelco.  
Système anti-renversement.  
Anti-roll system.

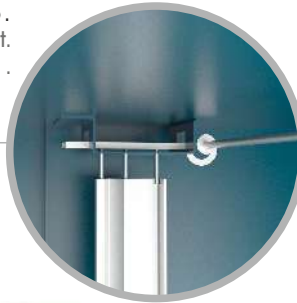

Cierre centralizado.  
Verrouillage centralisé.  
Central locking.

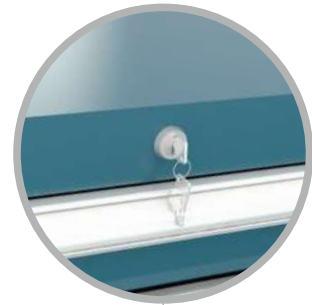

Guías simples.  
Glissières simples.  
Simple slides.

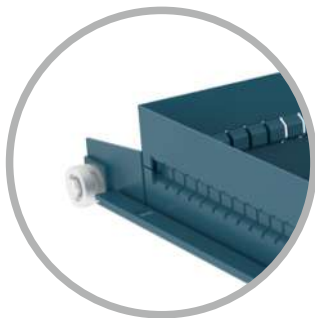

**GS** Apertura 90%.  
Ouverture 90%.  
90% opening.

SERIE 135 2

SERIE 135 1

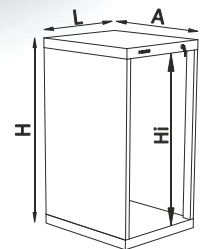
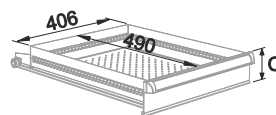

			LxAxH (mm)	Hi (mm)
135 1	23 Kg		515x600x700	600
135 2	30 Kg		515x600x1000	900
135 4	39,5 Kg		515x600x1400	1300

**e** 1 mm



**i** Los cajones no incluyen divisiones.  
Les tiroirs n'incluent pas les séparations.  
Divisions for drawers no included.

**i** ACCESORIOS. Ver información (PAG. 289).  
ACCESSOIRES. Voir information (PAG. 289).  
ACCESSORIES. See information (PAG. 289).

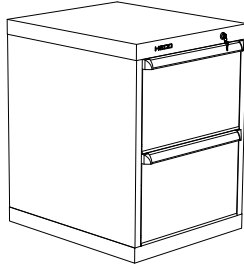

SERIE 135	C=75	●	GS 100 KG		GS 100 KG		PORTACONOS PORTE-CÔNES TOOL HOLDER	
			135 S100 C75	6,5Kg	135 S100 ISO 40			
	C=100	●	135 S100 C100	7Kg	135 S100 HSK 40			
	C=125	●	135 S100 C125	7,5Kg	135 S100 HSK 50			
	C=150	●	135 S100 C150	8Kg	135 S100 HSK 63			
	C=200	●	135 S100 C200	8,5Kg	135 S100 HSK 80			
	C=250	●	135 S100 C250	9,5Kg	135 S100 ISO 50			
	C=300	●	135 S100 C300	10,5Kg	135 S100 HSK 100	10,5Kg		
					<b>e</b> 1 mm			<b>e</b> 1 mm

SERIE 135 1 STANDARD

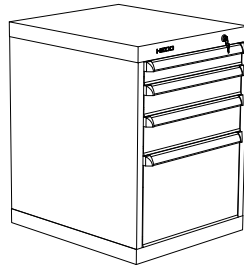

cajones/tiroirs/drawers			
135 1 11	44 Kg	 	2x 135 C300





cajones/tiroirs/drawers			
135 1 12	54,5 Kg	 	1x 135 C75 1x 135 C100 1x 135 C125 1x 135 C300



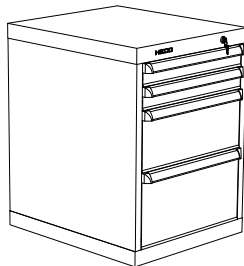

cajones/tiroirs/drawers			
135 1 13	55 Kg	 	4x 135 C150



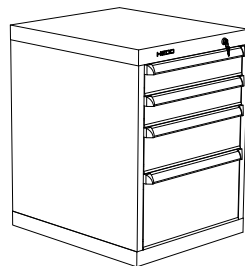

cajones/tiroirs/drawers			
135 1 14	54 Kg	 	2x 135 C75 1x 135 C200 1x 135 C250



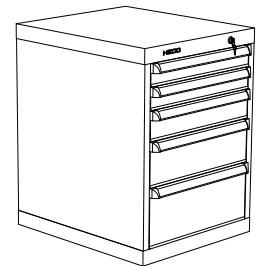

cajones/tiroirs/drawers			
135 1 15	54,5 Kg	 	2x 135 C100 1x 135 C150 1x 135 C250



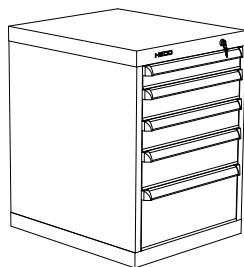

cajones/tiroirs/drawers			
135 1 16	59,5 Kg	 	2x 135 C75 1x 135 C100 1x 135 C150 1x 135 C200

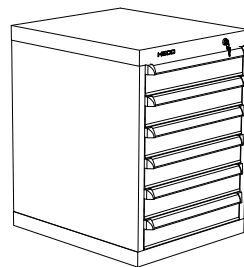

cajones/tiroirs/drawers			
135 1 17	59,5 Kg	 	1x 135 C75 2x 135 C100 1x 135 C125 1x 135 C200



cajones/tiroirs/drawers			
135 1 18	65 Kg	 	6x 135 C100

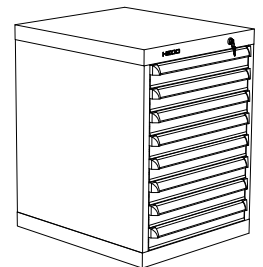

cajones/tiroirs/drawers			
135 1 19	75 Kg	 	8x 135 C75

SERIE 135 2 STANDARD

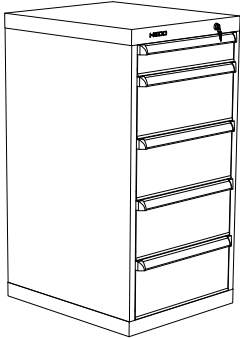

135 2 11	71 Kg			cajones/tiroirs/drawers
				1x 135 C100 4x 135 C200

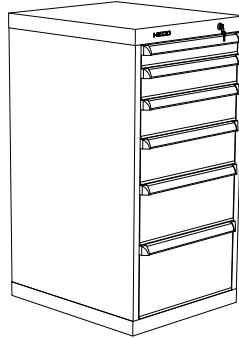

135 2 12	77 Kg			cajones/tiroirs/drawers
				1x 135 C75 1x 135 C100 1x 135 C125 1x 135 C150 1x 135 C200 1x 135 C250



135 2 13	78 Kg			cajones/tiroirs/drawers
				6x 135 C150

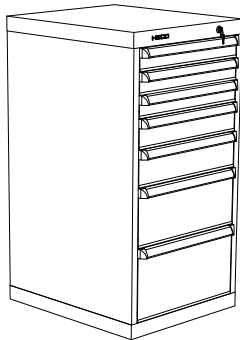

135 2 14	82 Kg			cajones/tiroirs/drawers
				3x 135 C75 1x 135 C100 1x 135 C125 1x 135 C200 1x 135 C250

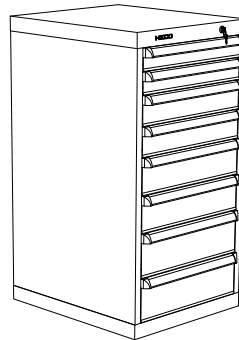

135 2 15	88 Kg			cajones/tiroirs/drawers
				2x 135 C75 2x 135 C100 2x 135 C125 2x 135 C150

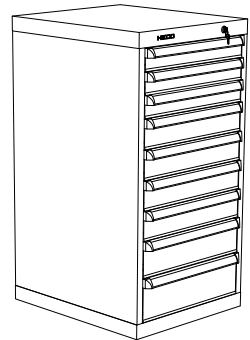

135 2 16	93 Kg			cajones/tiroirs/drawers
				3x 135 C75 4x 135 C100 1x 135 C125 1x 135 C150

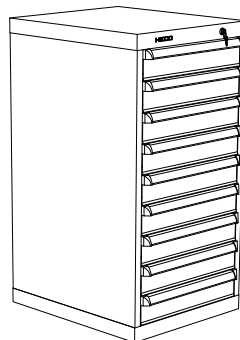

135 2 17	93 Kg			cajones/tiroirs/drawers
				9x 135 C100

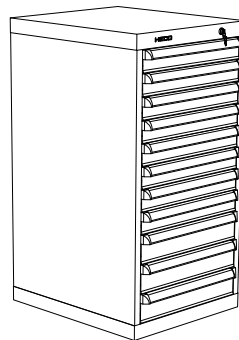

135 2 18	103 Kg			cajones/tiroirs/drawers
				8x 135 C75 3x 135 C100

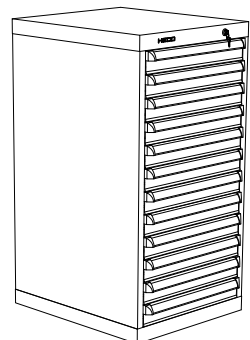



135 2 19	108 Kg			cajones/tiroirs/drawers
				12x 135 C75

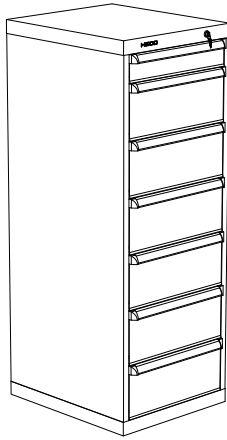

SERIE 135 4 STANDARD



cajones/tiroirs/drawers

135 4 11	97,5 Kg	 	1x 135 C100 6x 135 C200
----------	---------	---	----------------------------

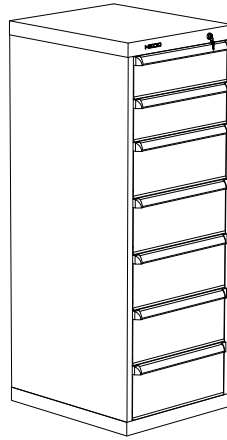

cajones/tiroirs/drawers

135 4 12	98 Kg	 	2x 135 C150 5x 135 C200
----------	-------	---	----------------------------

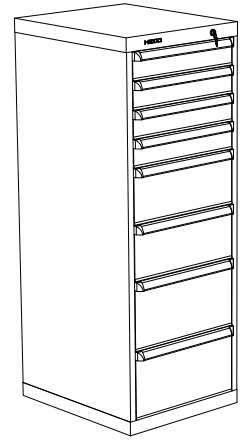

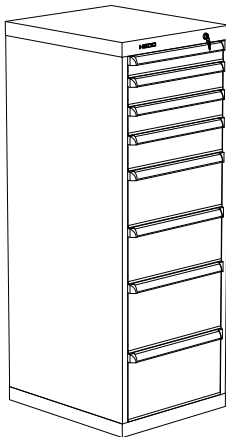

cajones/tiroirs/drawers

135 4 13	103,5 Kg	 	4x 135 C100 2x 135 C200 2x 135 C250
----------	----------	---	---



cajones/tiroirs/drawers

135 4 14	103,5 Kg	 	1x 135 C75 2x 135 C100 1x 135 C125 2x 135 C200 2x 135 C250
----------	----------	---	--

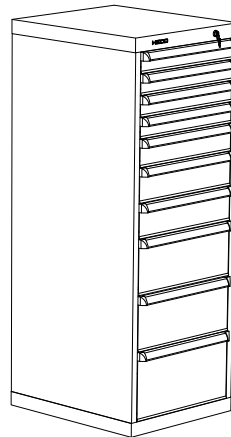

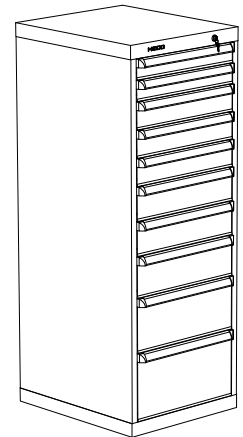

cajones/tiroirs/drawers

135 4 15	114 Kg	 	4x 135 C75 1x 135 C100 2x 135 C125 2x 135 C200 1x 135 C250
----------	--------	---	--



cajones/tiroirs/drawers

135 4 16	114,5 Kg	 	2x 135 C75 3x 135 C100 2x 135 C125 1x 135 C150 1x 135 C200 1x 135 C250
----------	----------	---	---

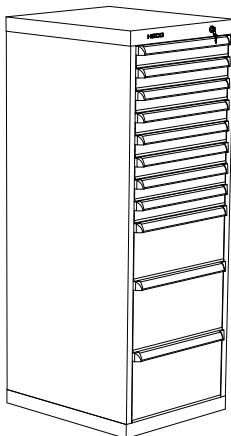

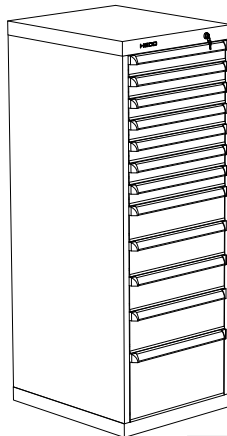

cajones/tiroirs/drawers

135 4 17	119 Kg	 	8x 135 C75 1x 135 C200 2x 135 C250
----------	--------	---	--



cajones/tiroirs/drawers

135 4 18	125 Kg	 	7x 135 C75 3x 135 C125 1x 135 C150 1x 135 C250
----------	--------	---	---

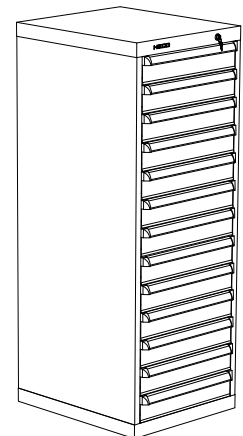

cajones/tiroirs/drawers

135 4 19	130,5 Kg	 	13x 135 C100
----------	----------	---	--------------

**SERIE 136 2** ref. 136 2 1 / 136 2 2



SERIE 136 2 1



SERIE 136 2 2



Sistema antivuelco.  
Système anti-renversement.  
Anti-roll system.

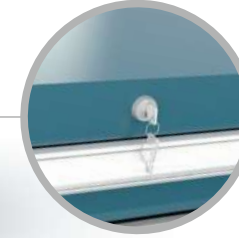

Cierre centralizado.  
Verrouillage centralisé.  
Central locking.

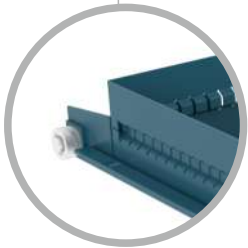
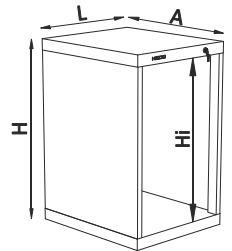

Guías simples.  
Glissières simples.  
Simple slides.

**GS** Apertura 90%.  
Ouverture 90%.  
90% opening.

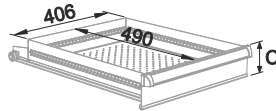

		LxAxH (mm)	Hi (mm)
136 2	25 Kg	515x600x830	725
136 2 1	62 Kg	515x600x830	725
136 2 2	67 Kg	515x600x830	725

**e** 1 mm

**i** Los cajones no incluyen divisiones.  
Les tiroirs n'incluent pas les séparations.  
Divisions for drawers no included.

**i** ACCESORIOS. Ver información (PAG. 289).  
ACCESSOIRES. Voir information (PAG. 289).  
ACCESSORIES. See information (PAG. 289).

	<b>GS</b> <b>100</b> <b>KG</b>	136 2 1	<b>GS</b> <b>100</b> <b>KG</b>	136 2 2	<b>GS</b> <b>100</b> <b>KG</b>	PORTACONOS PORTE-CÔNES TOOL HOLDER
SERIE 136 2	C=50					
	C=75	●	135 S100 C75 6,5Kg	● (x2)	135 S100 C75 6,5Kg	135 S100 ISO 40
	C=100	●	135 S100 C100 7Kg	●	135 S100 C100 7Kg	135 S100 HSK 50
	C=125	● (x2)	135 S100 C125 7,5Kg	●	135 S100 C125 7,5Kg	135 S100 HSK 63
	C=150			●	135 S100 C150 8Kg	135 S100 HSK 80
	C=200			●	135 S100 C200 8,5Kg	135 S100 ISO 50
C=250						135 S100 HSK 100 10,5Kg
C=300	●	135 S100 C300 10,5Kg				
	<b>e</b>	1 mm	<b>e</b>	1 mm	<b>e</b>	1 mm

**SERIE 136 2 1 STANDARD**



136 2 1	62 Kg	<b>GS</b> <b>100</b> <b>KG</b>	cajones/tiroirs/drawers
			1x 135 C75 1x 135 C100 2x 135 C125 1x 135 C300

**SERIE 136 2 2 STANDARD**



136 2 2	67 Kg	<b>GS</b> <b>100</b> <b>KG</b>	cajones/tiroirs/drawers
			2x 135 C75 1x 135 C100 1x 135 C125. 1x 135 C150 1x 135 C200

**SERIE 106** ref. 106 4 1 - 106 4 4

Armario con cajones de reducidas dimensiones ( 5 o 3 cajones).  
Armoire avec tiroirs de dimension réduites ( 5 ou 3 tiroirs).  
Cabinet with drawers of reduced dimension ( 5 or 3 drawers).

SERIE 106 4 1  
SERIE 106 4 2  
SERIE 106 4 3



SERIE 106 4 4

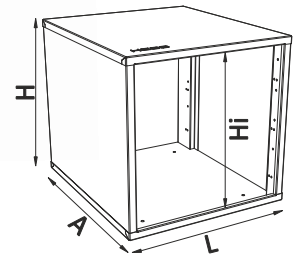
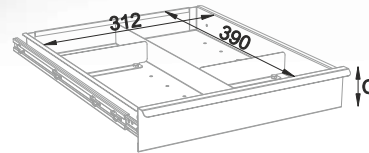

	LxAxH (mm)	Hi (mm)
106 4 1	28,49 Kg	370x420x360
106 4 2	30,03 Kg	
106 4 3	27,17 Kg	
106 4 4	20,63 Kg	

DIVISIONES SÉPARATIONS DIVISIONS



**e** 0.8 mm

			GT	15 KG
106 A	C=62	4,26 Kg	● (x5)	● (x3)
106 B	C=105	4,42 Kg		

**e** 0.8 mm

**SERIE 106 4 1** STANDARD

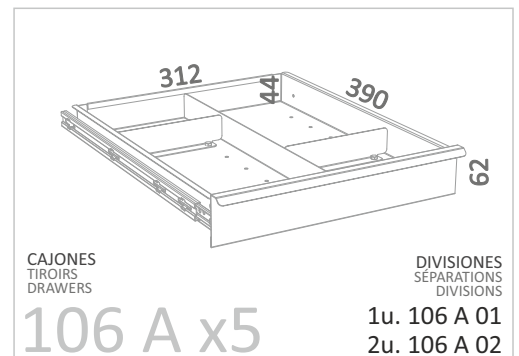
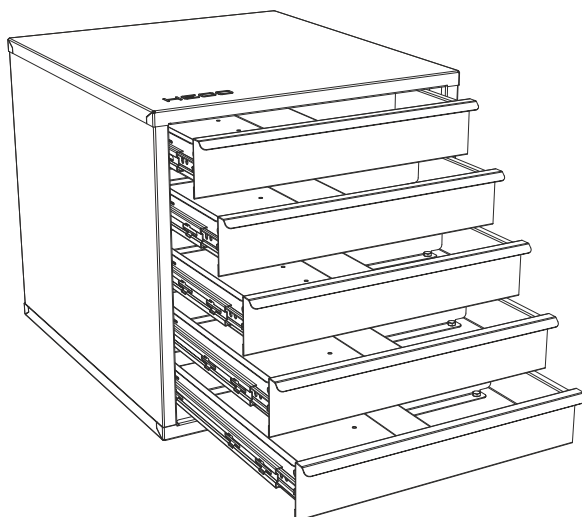

			L x A x H
106 4 1	28,49 Kg	1	370 x 420 x 360

componentes / composants / components	
106 A 01	longitudinal / longitudinale / lengthwise 386x37mm
106 A 02	transversal / transversale / transverse 151x37mm

### SERIE 106 4 2 STANDARD

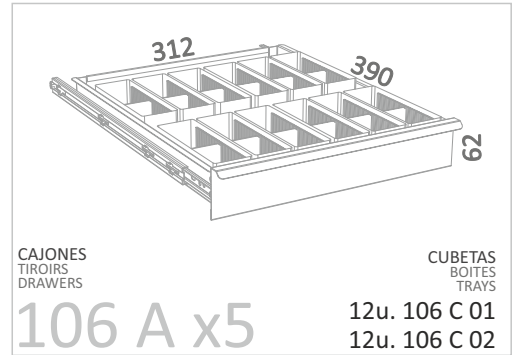
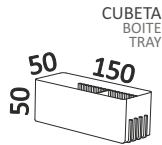
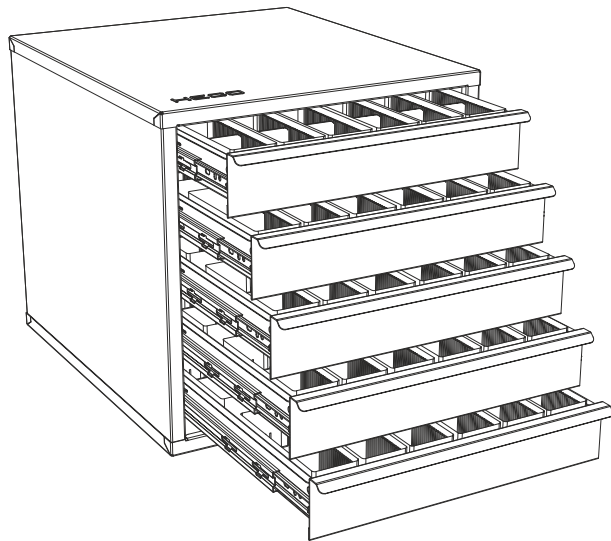

			L x A x H
106 4 2	30,03 Kg	1	370 x 420 x 360

componentes / composants / components

106 C 01 cubeta / boite / tray 150x52x47mm

106 C 02 division cubeta / séparation boite / tray division

### SERIE 106 4 3 STANDARD

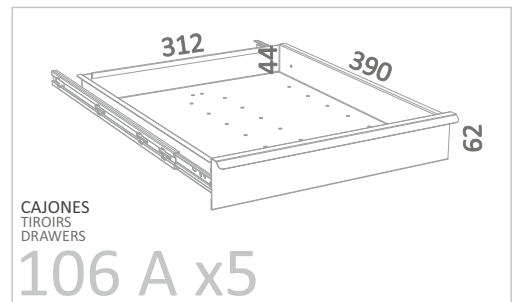
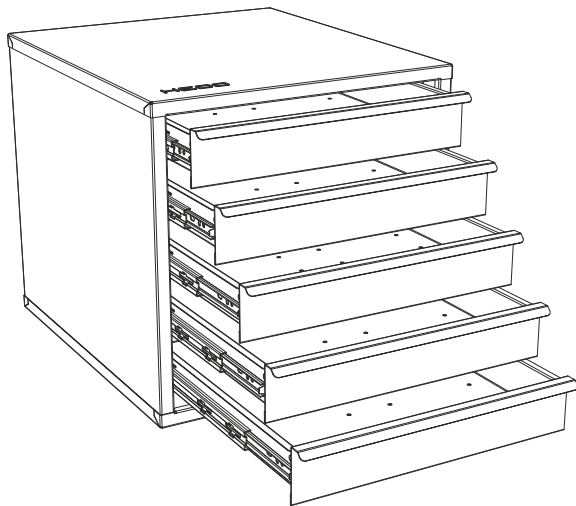

			L x A x H
106 4 3	27,17 Kg	1	370 x 420 x 360



Los cajones no incluyen divisiones.  
Les tiroirs n'incluent pas les séparations.  
Divisions for drawers no included.

### SERIE 106 4 4 STANDARD

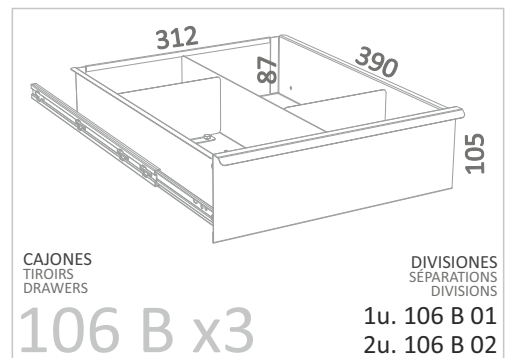
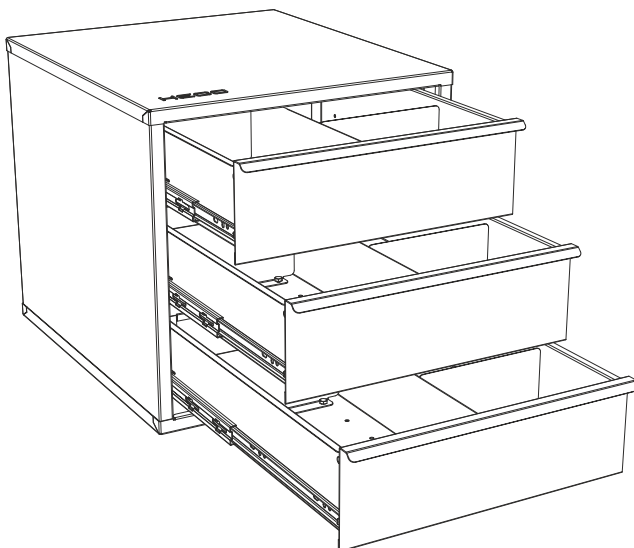

			L x A x H
106 4 4	20,63 Kg	1	370 x 420 x 360

componentes / composants / components

106 B 01 longitudinal / longitudinale / lengthwise 386x80mm

106 B 02 transversal / transversale / transverse 151x80mm

**SERIE 400** ref. 4200 / 4300 / 4400

Armarios archivadores.  
Armoire à classeurs.  
Closets filing cabinets.

oficinas / bureaux / offices

SERIE 4200



Cierre centralizado.  
Verrouillage centralisé.  
Central locking.

SERIE 4300

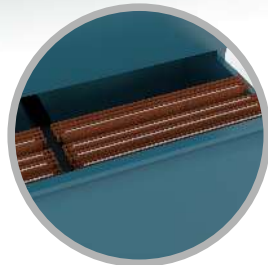

Soporte para archivadores. Incluidos en serie 400 F.  
Support pour classeurs. Inclus dans série 400 F.  
Folding - holder. Included at serie 400 F.

SERIE 4400

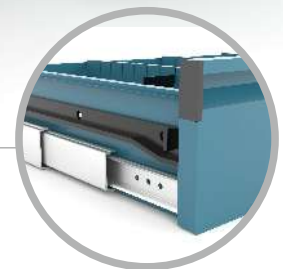

Bloqueo cajones y guías.  
Verrouillage des tiroirs et glissières.  
Locking drawers and slides.

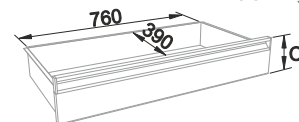

400 C	C=150	6,4 Kg
400 F	C=300	11 Kg

GT	50
e 0.8 mm	

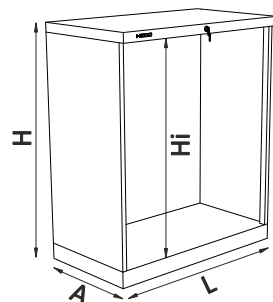

	L (mm)	A (mm)	H (mm)	Hi (mm)	cajones/tiroirs/drawers	
4204	41,8 Kg	862	465	716	600	4
4212	38,5 Kg					3
4220	35,5 Kg					2
4306	58,2 Kg	862	465	1018	900	6
4314	55 Kg					5
4322	52 Kg					4
4330	48,5 Kg	862	465	1320	1200	3
4408	74,6 Kg					8
4416	71,5 Kg					7
4424	68,2 Kg	862	465	1320	1200	6
4432	65 Kg					5
4440	61,8 Kg					4

e 0.8 mm



Los cajones no incluyen divisiones.  
Les tiroirs n'incluent pas les séparations.  
Divisions for drawers no included.



Para más información accesorios, ver PAG. 286.  
Pour plus d'information accessoires, voir PAGE. 286.  
For further information of accesories, see PAGE. 286.



Consultar plazo de entrega.  
Consulter le delai de livraison.  
Check delivery time.



## SERIE 4200 STANDARD

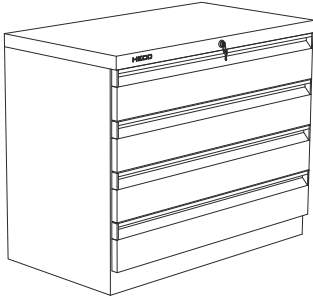

4204	41.8 Kg		cajones/tiroirs/drawers 4x 400 C
------	---------	--	-------------------------------------

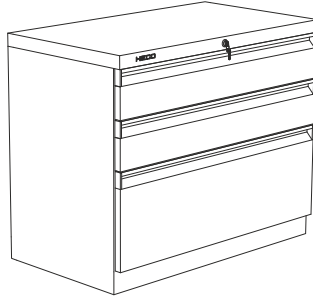

4212	38.5 Kg		cajones/tiroirs/drawers 2x 400 C 1x 400 F
------	---------	--	---

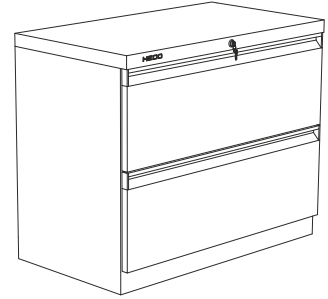

4220	35.5 Kg		cajones/tiroirs/drawers 2x 400 F
------	---------	--	-------------------------------------

## SERIE 4300 STANDARD



4306	58,2 Kg		cajones/tiroirs/drawers 6x 400 C
------	---------	--	-------------------------------------



4314	55 Kg		cajones/tiroirs/drawers 4x 400 C 1x 400 F
------	-------	--	---

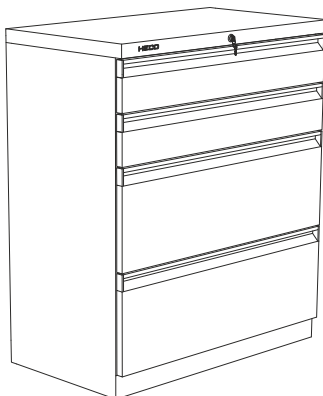

4322	52 Kg		cajones/tiroirs/drawers 2x 400 C 2x 400 F
------	-------	--	---



4330	48,5 Kg		cajones/tiroirs/drawers 3x 400 F
------	---------	--	-------------------------------------



SERIE 4400 STANDARD



4408	74,6 Kg		cajones/tiroirs/drawers
			8x 400 C

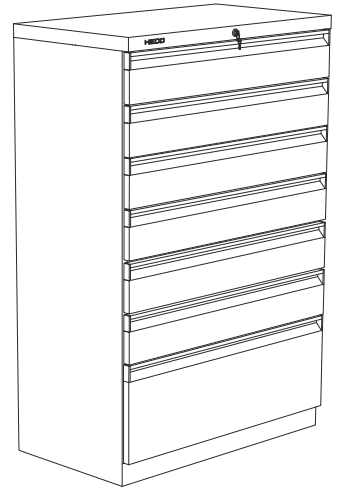

4416	71,5 Kg		cajones/tiroirs/drawers
			6x 400 C 1x 400 F

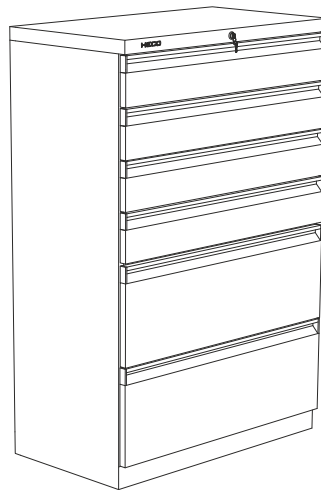

4424	68,2 Kg		cajones/tiroirs/drawers
			4x 400 C 2x 400 F

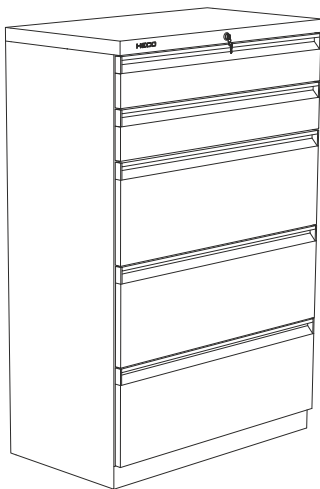

4432	65 Kg		cajones/tiroirs/drawers
			2x 400 C 3x 400 F



4440	61,8 Kg		cajones/tiroirs/drawers
			4x 400 F

## SERIE 400 DIVISIONES / SEPARATIONS / DIVISORS

Composición de divisiones estandar para armarios de oficinas.  
 Composition standard de séparations pour armoires de bureaux.  
 Standard divisions compositions for offices cabinets.

### ESTANDARD / STANDARD / STANDARD

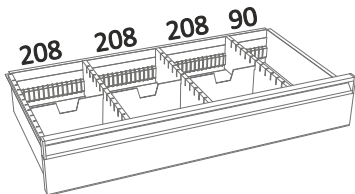

	cajón/tiroir/drawer	divisiones/séparations/divisions
400 43 C	400 C (Hf 150mm)	1x 400 RF C 3x 400 C 208 5x 400 RL C 1x 400 RA C

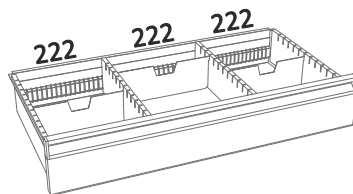

	cajón/tiroir/drawer	divisiones/séparations/divisions
400 44 C	400 C (Hf 150mm)	1x 400 RF F 3x 400 C 222 4x 400 RL C 1x 400 RA C

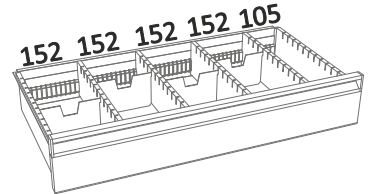

	cajón/tiroir/drawer	divisiones/séparations/divisions
400 45 C	400 C (Hf 150mm)	1x 400 RF C 4x 400 C 152 7x 400 RL C 1x 400 RA C

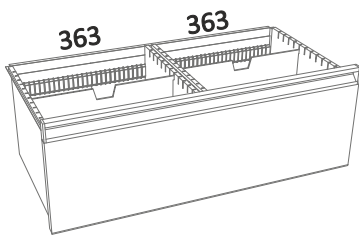

	cajón/tiroir/drawer	divisiones/séparations/divisions
400 33 F	400 F (Hf 300mm)	1x 400 RF F 2x 400 F 363 2x 400 RL F 1x 400 RA F

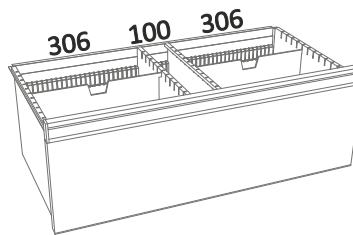

	cajón/tiroir/drawer	divisiones/séparations/divisions
400 35 F	400 F (Hf 300mm)	1x 400 RF F 2x 400 F 306 2x 400 RL F 1x 400 RA F

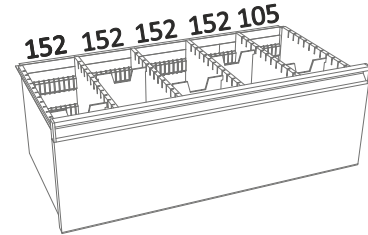

	cajón/tiroir/drawer	divisiones/séparations/divisions
400 40 F	400 F (Hf 300mm)	1x 400 RF F 2x 400 F 152 7x 400 RL F 1x 400 RA F

### ACCESORIOS / ACCESSOIRES / ACCESSORIES



L 82 / 110 / 138 / 152 / 208 / 222

400 C  
e 1.5 mm

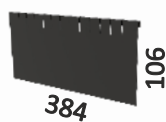

400 RL C  
e 1 mm



400 RA/RF C  
e 1+0.6 mm

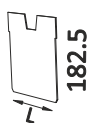

L 110 / 152 / 222 / 250 / 306 / 348 / 363

400 F  
e 1.5 mm

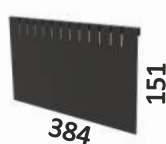

400 RL F  
e 1 mm



400 RA/RF F  
e 1+0.6 mm



INFO

CAJONES TIROIRS DRAWERS

**Hf** Altura frontal.  
Hauteur frontale.  
Front height.

**Hu** Altura útil.  
Hauteur utile.  
Useable height.

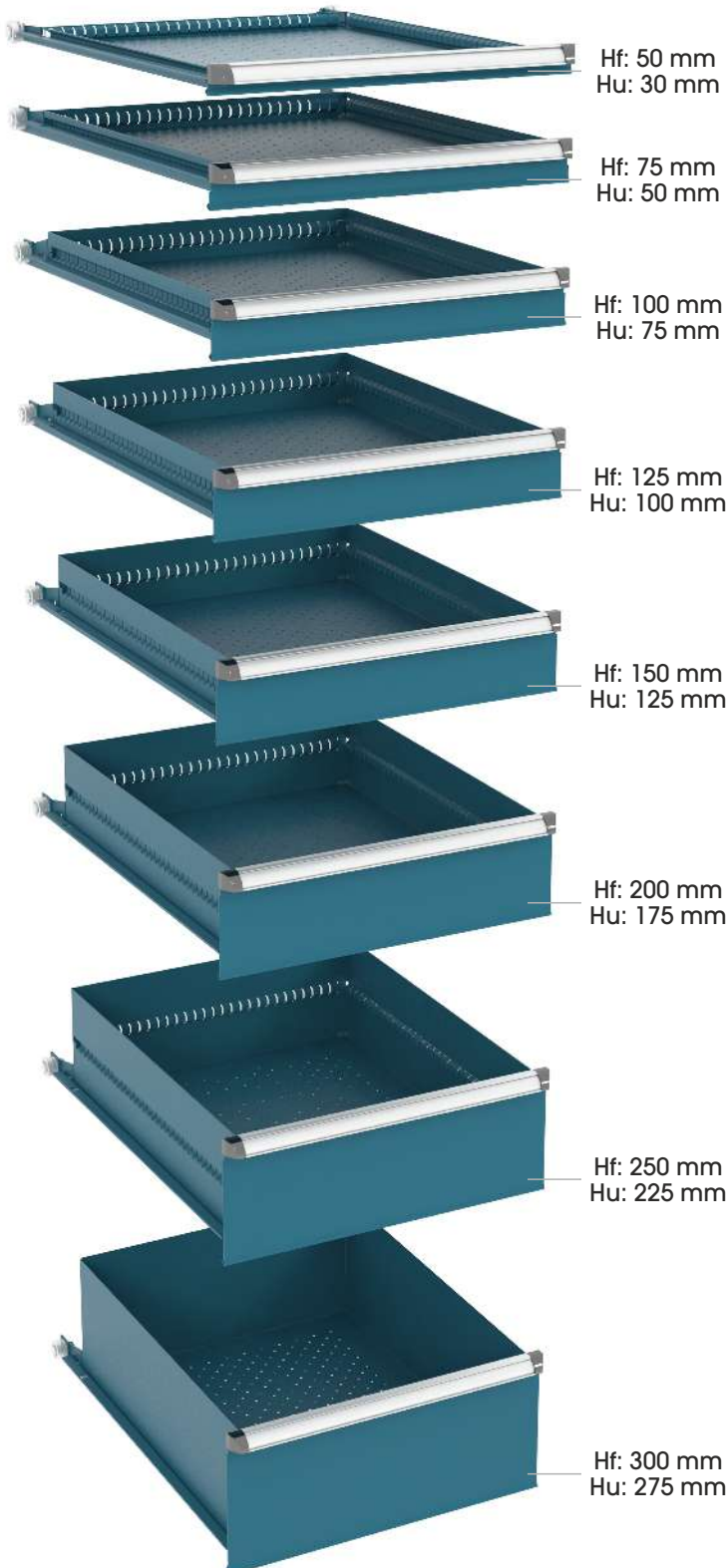

INFO

GUIAS GLISSIÈRES SLIDES



GS

100  
KG

- Guía Simple 100kg / Apertura 90%.
- Glissière Simple 100kg / Ouverture 90%.
- Simple Slide 100kg / 90% opening.

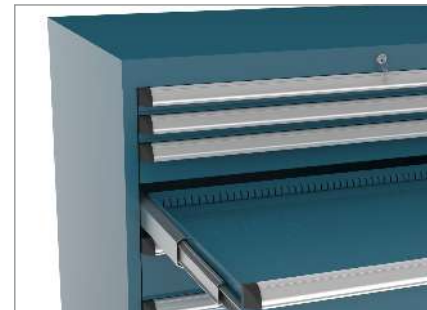

GT

50  
KG

- Guía Telescópica 50kg / Apertura 100%.
- Glissière Télescopique 50kg / Ouverture 100%.
- Telescopic Slide 50kg / 100% opening.

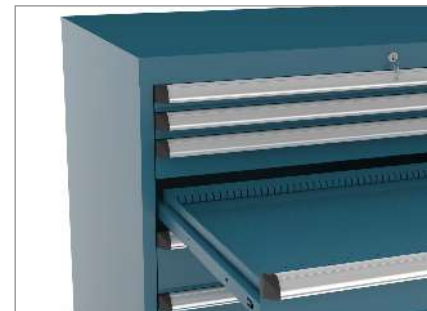

GT

100  
KG

- Guía Telescópica 100kg / Apertura 100%.
- Glissière Télescopique 100kg / Ouverture 100%.
- Telescopic Slide 100kg / 100% opening.



GT

200  
KG

- Guía Telescópica 200kg / Apertura 100%.
- Glissière Télescopique 200kg / Ouverture 100%.
- Telescopic Slide 200kg / 100% opening.

# INFO: EX NOMENCLATURA CAJONES NOMENCLATURE TIROIRS DRAWERS NAMING

Ejemplo para la elección de cajones, válido para el resto de series.  
 Exemple de sélection de tiroirs, valable pour toutes les autres séries.  
 Example for the selection of drawers, valid for all other series.

<b>SERIE SÉRIE SERIES</b> 115/126/127 119 122 123 135	+	<b>GUIAS GLISSIÈRES SLIDES</b> <table border="1" style="margin: 0 auto;"> <tr> <td style="padding: 2px;">GS</td> <td style="padding: 2px;">GT</td> <td style="padding: 2px;">GT</td> <td style="padding: 2px;">GT</td> </tr> <tr> <td style="padding: 2px; background-color: red; color: white;">100</td> <td style="padding: 2px; background-color: red; color: white;">50</td> <td style="padding: 2px; background-color: red; color: white;">100</td> <td style="padding: 2px; background-color: red; color: white;">200</td> </tr> </table>	GS	GT	GT	GT	100	50	100	200	+	<b>CAJONES TIROIRS DRAWERS</b> Hf <small>Altura frontal. Hauteur frontale. Front height.</small>
GS	GT	GT	GT									
100	50	100	200									

ex.

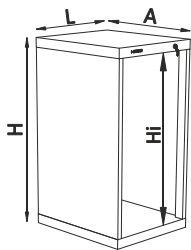

	LxAxH (mm)	Hi (mm)
135 1	515x600x700	600
135 2	515x600x1000	900
135 4	515x600x1400	1300

**e** 1 mm

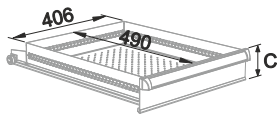

SERIE 135	C=75	C=100	C=125	C=150	C=200	C=250	C=300	GUIAS GLISSIÈRES SLIDES	
								GS	100
								●	x2
								●	
								●	
								●	
								●	
								●	
								●	

**e** 1 mm

**SERIE 135 2**  
(515x600x1000)  
Hi 900 mm

composición composition composition

SERIE SÉRIE	GUIAS GLISSIÈRES SLIDES	CAJONES TIROIRS DRAWERS
135	S100	C075
135	S100	C075
135	S100	C100
135	S100	C150
135	S100	C200
135	S100	C300

**=Hi** <<<

**PEDIDO**  
**COMMANDE**  
**ORDER**

**SERIE 135 2**  
2u. 135 S100 C075  
135 S100 C100  
135 S100 C150  
135 S100 C200  
135 S100 C300

## INFO CAJONES / TIROIRS / DRAWERS

Para SERIE 115/119/143/122/123/135/126/127.  
 Pour SÉRIE 115/119/143/122/123/135/126/127.  
 For SERIES 115/119/143/122/123/135/126/127.

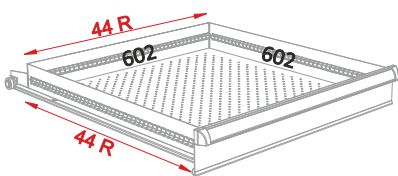

115-126-127

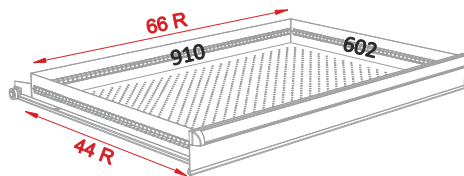

119

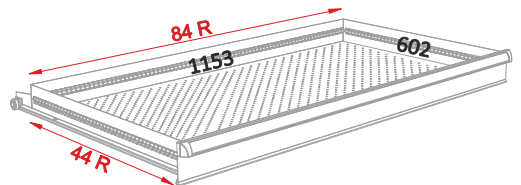

143

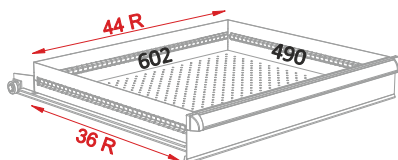

122

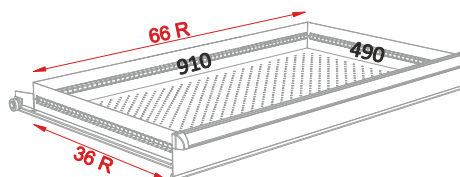

123

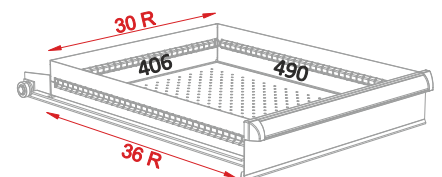

135

REFERENCES DIVISIONES / INTERCALAIRES / DIVISORS

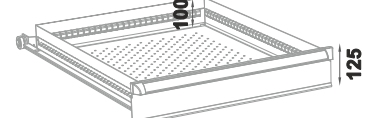
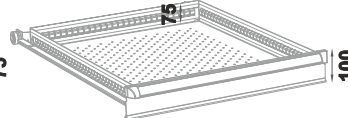
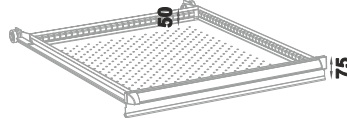
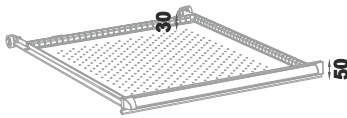

CAJON TIROIR DRAWER **C50**

DIVISIONES RANURADAS  
DIVISIONS RAINURÉES  
SLOTTED DIVISORS

**SERIE 115,119**

ref.	LxAxH
<b>050 R</b>	610x14x30 mm

DIVISIONES PLANAS  
INTERCALAIRES  
SIMPLE DIVISORS

ref.	Hf +R	Lu	Ld
<b>050 04</b>	42 mm	53 mm	
<b>050 05</b>	56 mm	67 mm	
<b>050 06</b>	70 mm	81 mm	
<b>050 07</b>	84 mm	95 mm	
<b>050 08</b>	98 mm	109 mm	
<b>050 09</b>	112 mm	123 mm	
<b>050 10</b>	126 mm	137 mm	
<b>050 11</b>	140 mm	151 mm	
<b>050 12</b>	154 mm	165 mm	
<b>050 13</b>	168 mm	179 mm	
<b>050 14</b>	182 mm	193 mm	
<b>050 15</b>	196 mm	207 mm	
<b>050 16</b>	210 mm	221 mm	
<b>050 17</b>	224 mm	235 mm	
<b>050 18</b>	238 mm	249 mm	
<b>050 19</b>	252 mm	263 mm	
<b>050 20</b>	266 mm	277 mm	
<b>050 21</b>	280 mm	291 mm	
<b>050 22</b>	294 mm	305 mm	
<b>050 23</b>	308 mm	319 mm	
<b>050 24</b>	322 mm	333 mm	
<b>050 25</b>	336 mm	347 mm	
<b>050 26</b>	350 mm	361 mm	
<b>050 27</b>	364 mm	375 mm	
<b>050 28</b>	378 mm	389 mm	
<b>050 29</b>	392 mm	403 mm	
<b>050 30</b>	406 mm	417 mm	
<b>050 31</b>	420 mm	431 mm	
<b>050 32</b>	434 mm	445 mm	
<b>050 33</b>	448 mm	459 mm	
<b>050 34</b>	462 mm	473 mm	
<b>050 35</b>	476 mm	487 mm	
<b>050 36</b>	490 mm	501 mm	
<b>050 37</b>	504 mm	515 mm	
<b>050 38</b>	518 mm	529 mm	
<b>050 39</b>	532 mm	543 mm	
<b>050 40</b>	546 mm	557 mm	
<b>050 41</b>	560 mm	571 mm	
<b>050 42</b>	574 mm	585 mm	
<b>050 43</b>	588 mm	599 mm	
<b>050 44</b>	602 mm	613 mm	

CAJON TIROIR DRAWER **C75**

DIVISIONES RANURADAS  
DIVISIONS RAINURÉES  
SLOTTED DIVISORS

**SERIE 115,119,143**

ref.	LxAxH
<b>075 R</b>	610x14x50 mm

**SERIE 135,122,123**

ref.	LxAxH
<b>135 075 R</b>	498x14x50 mm

DIVISIONES PLANAS  
INTERCALAIRES  
SIMPLE DIVISORS

ref.	Hf +R	Lu	Ld
<b>075 04</b>	42 mm	53 mm	
<b>075 05</b>	56 mm	67 mm	
<b>075 06</b>	70 mm	81 mm	
<b>075 07</b>	84 mm	95 mm	
<b>075 08</b>	98 mm	109 mm	
<b>075 09</b>	112 mm	123 mm	
<b>075 10</b>	126 mm	137 mm	
<b>075 11</b>	140 mm	151 mm	
<b>075 12</b>	154 mm	165 mm	
<b>075 13</b>	168 mm	179 mm	
<b>075 14</b>	182 mm	193 mm	
<b>075 15</b>	196 mm	207 mm	
<b>075 16</b>	210 mm	221 mm	
<b>075 17</b>	224 mm	235 mm	
<b>075 18</b>	238 mm	249 mm	
<b>075 19</b>	252 mm	263 mm	
<b>075 20</b>	266 mm	277 mm	
<b>075 21</b>	280 mm	291 mm	
<b>075 22</b>	294 mm	305 mm	
<b>075 23</b>	308 mm	319 mm	
<b>075 24</b>	322 mm	333 mm	
<b>075 25</b>	336 mm	347 mm	
<b>075 26</b>	350 mm	361 mm	
<b>075 27</b>	364 mm	375 mm	
<b>075 28</b>	378 mm	389 mm	
<b>075 29</b>	392 mm	403 mm	
<b>075 30</b>	406 mm	417 mm	
<b>075 31</b>	420 mm	431 mm	
<b>075 32</b>	434 mm	445 mm	
<b>075 33</b>	448 mm	459 mm	
<b>075 34</b>	462 mm	473 mm	
<b>075 35</b>	476 mm	487 mm	
<b>075 36</b>	490 mm	501 mm	
<b>075 37</b>	504 mm	515 mm	
<b>075 38</b>	518 mm	529 mm	
<b>075 39</b>	532 mm	543 mm	
<b>075 40</b>	546 mm	557 mm	
<b>075 41</b>	560 mm	571 mm	
<b>075 42</b>	574 mm	585 mm	
<b>075 43</b>	588 mm	599 mm	
<b>075 44</b>	602 mm	613 mm	

CAJON TIROIR DRAWER **C100**

DIVISIONES RANURADAS  
DIVISIONS RAINURÉES  
SLOTTED DIVISORS

**SERIE 115,119,143**

ref.	LxAxH
<b>100 R</b>	610x14x75 mm

**SERIE 135,122,123**

ref.	LxAxH
<b>135 100 R</b>	498x14x75 mm

DIVISIONES PLANAS  
INTERCALAIRES  
SIMPLE DIVISORS

ref.	Hf +R	Lu	Ld
<b>100 04</b>	42 mm	53 mm	
<b>100 05</b>	56 mm	67 mm	
<b>100 06</b>	70 mm	81 mm	
<b>100 07</b>	84 mm	95 mm	
<b>100 08</b>	98 mm	109 mm	
<b>100 09</b>	112 mm	123 mm	
<b>100 10</b>	126 mm	137 mm	
<b>100 11</b>	140 mm	151 mm	
<b>100 12</b>	154 mm	165 mm	
<b>100 13</b>	168 mm	179 mm	
<b>100 14</b>	182 mm	193 mm	
<b>100 15</b>	196 mm	207 mm	
<b>100 16</b>	210 mm	221 mm	
<b>100 17</b>	224 mm	235 mm	
<b>100 18</b>	238 mm	249 mm	
<b>100 19</b>	252 mm	263 mm	
<b>100 20</b>	266 mm	277 mm	
<b>100 21</b>	280 mm	291 mm	
<b>100 22</b>	294 mm	305 mm	
<b>100 23</b>	308 mm	319 mm	
<b>100 24</b>	322 mm	333 mm	
<b>100 25</b>	336 mm	347 mm	
<b>100 26</b>	350 mm	361 mm	
<b>100 27</b>	364 mm	375 mm	
<b>100 28</b>	378 mm	389 mm	
<b>100 29</b>	392 mm	403 mm	
<b>100 30</b>	406 mm	417 mm	
<b>100 31</b>	420 mm	431 mm	
<b>100 32</b>	434 mm	445 mm	
<b>100 33</b>	448 mm	459 mm	
<b>100 34</b>	462 mm	473 mm	
<b>100 35</b>	476 mm	487 mm	
<b>100 36</b>	490 mm	501 mm	
<b>100 37</b>	504 mm	515 mm	
<b>100 38</b>	518 mm	529 mm	
<b>100 39</b>	532 mm	543 mm	
<b>100 40</b>	546 mm	557 mm	
<b>100 41</b>	560 mm	571 mm	
<b>100 42</b>	574 mm	585 mm	
<b>100 43</b>	588 mm	599 mm	
<b>100 44</b>	602 mm	613 mm	

CAJON TIROIR DRAWER **C125**

DIVISIONES RANURADAS  
DIVISIONS RAINURÉES  
SLOTTED DIVISORS

**SERIE 115,119,143**

ref.	LxAxH
<b>125 R</b>	610x14x100 mm

**SERIE 135,122,123**

ref.	LxAxH
<b>135 125 R</b>	498x14x100 mm

DIVISIONES PLANAS  
INTERCALAIRES  
SIMPLE DIVISORS

ref.	Hf +R	Lu	Ld
<b>125 04</b>	42 mm	53 mm	
<b>125 05</b>	56 mm	67 mm	
<b>125 06</b>	70 mm	81 mm	
<b>125 07</b>	84 mm	95 mm	
<b>125 08</b>	98 mm	109 mm	
<b>125 09</b>	112 mm	123 mm	
<b>125 10</b>	126 mm	137 mm	
<b>125 11</b>	140 mm	151 mm	
<b>125 12</b>	154 mm	165 mm	
<b>125 13</b>	168 mm	179 mm	
<b>125 14</b>	182 mm	193 mm	
<b>125 15</b>	196 mm	207 mm	
<b>125 16</b>	210 mm	221 mm	
<b>125 17</b>	224 mm	235 mm	
<b>125 18</b>	238 mm	249 mm	
<b>125 19</b>	252 mm	263 mm	
<b>125 20</b>	266 mm	277 mm	
<b>125 21</b>	280 mm	291 mm	
<b>125 22</b>	294 mm	305 mm	
<b>125 23</b>	308 mm	319 mm	
<b>125 24</b>	322 mm	333 mm	
<b>125 25</b>	336 mm	347 mm	
<b>125 26</b>	350 mm	361 mm	
<b>125 27</b>	364 mm	375 mm	
<b>125 28</b>	378 mm	389 mm	
<b>125 29</b>	392 mm	403 mm	
<b>125 30</b>	406 mm	417 mm	
<b>125 31</b>	420 mm	431 mm	
<b>125 32</b>	434 mm	445 mm	
<b>125 33</b>	448 mm	459 mm	
<b>125 34</b>	462 mm	473 mm	
<b>125 35</b>	476 mm	487 mm	
<b>125 36</b>	490 mm	501 mm	
<b>125 37</b>	504 mm	515 mm	
<b>125 38</b>	518 mm	529 mm	
<b>125 39</b>	532 mm	543 mm	
<b>125 40</b>	546 mm	557 mm	
<b>125 41</b>	560 mm	571 mm	
<b>125 42</b>	574 mm	585 mm	
<b>125 43</b>	588 mm	599 mm	
<b>125 44</b>	602 mm	613 mm	

**Hf** Altura frontal cajón.  
Hauteur frontale tiroir.  
Drawer front height.

**R** Ranuras ocupadas.  
Rainures occupées.  
Slots to be used.

**Lu** Longitud útil.  
Longueur utile.  
Useful length width.

**Ld** Longitud real de la pieza.  
Longueur réelle de la pièce.  
Real length width from piece.

REFERENCES DIVISIONES / INTERCALAIRES / DIVISORS

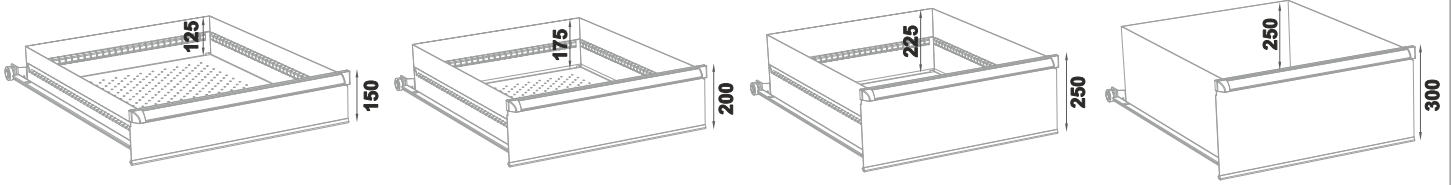

**CAJON TIROIR DRAWER C150**

DIVISIONES RANURADAS  
DIVISIONS RAINURÉES  
SLOTTED DIVISORS

**SERIE 115,119,143**

ref.	LxAxH
150 R	610x14x125 mm

**SERIE 135,122,123**

ref.	LxAxH
135 150 R	498x14x125 mm

DIVISIONES PLANAS  
INTERCALAIRES  
SIMPLE DIVISORS

ref.	Hf + R	Lu	Ld
150 04	42 mm	53 mm	
150 05	56 mm	67 mm	
150 06	70 mm	81 mm	
150 07	84 mm	95 mm	
150 08	98 mm	109 mm	
150 09	112 mm	123 mm	
150 10	126 mm	137 mm	
150 11	140 mm	151 mm	
150 12	154 mm	165 mm	
150 13	168 mm	179 mm	
150 14	182 mm	193 mm	
150 15	196 mm	207 mm	
150 16	210 mm	221 mm	
150 17	224 mm	235 mm	
150 18	238 mm	249 mm	
150 19	252 mm	263 mm	
150 20	266 mm	277 mm	
150 21	280 mm	291 mm	
150 22	294 mm	305 mm	
150 23	308 mm	319 mm	
150 24	322 mm	333 mm	
150 25	336 mm	347 mm	
150 26	350 mm	361 mm	
150 27	364 mm	375 mm	
150 28	378 mm	389 mm	
150 29	392 mm	403 mm	
150 30	406 mm	417 mm	
150 31	420 mm	431 mm	
150 32	434 mm	445 mm	
150 33	448 mm	459 mm	
150 34	462 mm	473 mm	
150 35	476 mm	487 mm	
150 36	490 mm	501 mm	
150 37	504 mm	515 mm	
150 38	518 mm	529 mm	
150 39	532 mm	543 mm	
150 40	546 mm	557 mm	
150 41	560 mm	571 mm	
150 42	574 mm	585 mm	
150 43	588 mm	599 mm	
150 44	602 mm	613 mm	

**CAJON TIROIR DRAWER C200**

DIVISIONES RANURADAS  
DIVISIONS RAINURÉES  
SLOTTED DIVISORS

**SERIE 115,119,143**

ref.	LxAxH
200 R	610x14x175 mm

**SERIE 135,122,123**

ref.	LxAxH
135 200 R	498x14x175 mm

DIVISIONES PLANAS  
INTERCALAIRES  
SIMPLE DIVISORS

ref.	Hf + R	Lu	Ld
200 04	42 mm	53 mm	
200 05	56 mm	67 mm	
200 06	70 mm	81 mm	
200 07	84 mm	95 mm	
200 08	98 mm	109 mm	
200 09	112 mm	123 mm	
200 10	126 mm	137 mm	
200 11	140 mm	151 mm	
200 12	154 mm	165 mm	
200 13	168 mm	179 mm	
200 14	182 mm	193 mm	
200 15	196 mm	207 mm	
200 16	210 mm	221 mm	
200 17	224 mm	235 mm	
200 18	238 mm	249 mm	
200 19	252 mm	263 mm	
200 20	266 mm	277 mm	
200 21	280 mm	291 mm	
200 22	294 mm	305 mm	
200 23	308 mm	319 mm	
200 24	322 mm	333 mm	
200 25	336 mm	347 mm	
200 26	350 mm	361 mm	
200 27	364 mm	375 mm	
200 28	378 mm	389 mm	
200 29	392 mm	403 mm	
200 30	406 mm	417 mm	
200 31	420 mm	431 mm	
200 32	434 mm	445 mm	
200 33	448 mm	459 mm	
200 34	462 mm	473 mm	
200 35	476 mm	487 mm	
200 36	490 mm	501 mm	
200 37	504 mm	515 mm	
200 38	518 mm	529 mm	
200 39	532 mm	543 mm	
200 40	546 mm	557 mm	
200 41	560 mm	571 mm	
200 42	574 mm	585 mm	
200 43	588 mm	599 mm	
200 44	602 mm	613 mm	

**CAJON TIROIR DRAWER C250**

DIVISIONES RANURADAS  
DIVISIONS RAINURÉES  
SLOTTED DIVISORS

**SERIE 115,119,143**

ref.	LxAxH
250 R	610x14x225 mm

**SERIE 135,122,123**

ref.	LxAxH
135 250 R	498x14x225 mm

DIVISIONES PLANAS  
INTERCALAIRES  
SIMPLE DIVISORS

ref.	Hf + R	Lu	Ld
250 04	42 mm	53 mm	
250 05	56 mm	67 mm	
250 06	70 mm	81 mm	
250 07	84 mm	95 mm	
250 08	98 mm	109 mm	
250 09	112 mm	123 mm	
250 10	126 mm	137 mm	
250 11	140 mm	151 mm	
250 12	154 mm	165 mm	
250 13	168 mm	179 mm	
250 14	182 mm	193 mm	
250 15	196 mm	207 mm	
250 16	210 mm	221 mm	
250 17	224 mm	235 mm	
250 18	238 mm	249 mm	
250 19	252 mm	263 mm	
250 20	266 mm	277 mm	
250 21	280 mm	291 mm	
250 22	294 mm	305 mm	
250 23	308 mm	319 mm	
250 24	322 mm	333 mm	
250 25	336 mm	347 mm	
250 26	350 mm	361 mm	
250 27	364 mm	375 mm	
250 28	378 mm	389 mm	
250 29	392 mm	403 mm	
250 30	406 mm	417 mm	
250 31	420 mm	431 mm	
250 32	434 mm	445 mm	
250 33	448 mm	459 mm	
250 34	462 mm	473 mm	
250 35	476 mm	487 mm	
250 36	490 mm	501 mm	
250 37	504 mm	515 mm	
250 38	518 mm	529 mm	
250 39	532 mm	543 mm	
250 40	546 mm	557 mm	
250 41	560 mm	571 mm	
250 42	574 mm	585 mm	
250 43	588 mm	599 mm	
250 44	602 mm	613 mm	

**CAJON TIROIR DRAWER C300**

DIVISIONES RANURADAS  
DIVISIONS RAINURÉES  
SLOTTED DIVISORS

**SERIE 115,119**

ref.	LxAxH
300 R	610x14x250 mm

DIVISIONES PLANAS  
INTERCALAIRES  
SIMPLE DIVISORS

ref.	Hf + R	Lu	Ld
300 04	42 mm	53 mm	
300 05	56 mm	67 mm	
300 06	70 mm	81 mm	
300 07	84 mm	95 mm	
300 08	98 mm	109 mm	
300 09	112 mm	123 mm	
300 10	126 mm	137 mm	
300 11	140 mm	151 mm	
300 12	154 mm	165 mm	
300 13	168 mm	179 mm	
300 14	182 mm	193 mm	
300 15	196 mm	207 mm	
300 16	210 mm	221 mm	
300 17	224 mm	235 mm	
300 18	238 mm	249 mm	
300 19	252 mm	263 mm	
300 20	266 mm	277 mm	
300 21	280 mm	291 mm	
300 22	294 mm	305 mm	
300 23	308 mm	319 mm	
300 24	322 mm	333 mm	
300 25	336 mm	347 mm	
300 26	350 mm	361 mm	
300 27	364 mm	375 mm	
300 28	378 mm	389 mm	
300 29	392 mm	403 mm	
300 30	406 mm	417 mm	
300 31	420 mm	431 mm	
300 32	434 mm	445 mm	
300 33	448 mm	459 mm	
300 34	462 mm	473 mm	
300 35	476 mm	487 mm	
300 36	490 mm	501 mm	
300 37	504 mm	515 mm	
300 38	518 mm	529 mm	
300 39	532 mm	543 mm	
300 40	546 mm	557 mm	
300 41	560 mm	571 mm	
300 42	574 mm	585 mm	
300 43	588 mm	599 mm	
300 44	602 mm	613 mm	

**Hf** Altura frontal cajón.  
Hauteur frontale tiroir.  
Drawer front height.

**R** Ranuras ocupadas.  
Rainures occupées.  
Slots to be used.

**Lu** Longitud útil.  
Longueur utile.  
Useful length width.

**Ld** Longitud real de la pieza.  
Longueur réelle de la pièce.  
Real length width from piece.

**INFO: EX** DIVISIONES DE CAJONES SEPARATIONS DES TIROIRS / DRAWER DIVISIONS

Ejemplo para la elección de divisiones ranuradas y planas, válido para el resto de series.  
Exemple de sélection des séparations et intercalaires, valable pour toutes les autres séries.  
Example for the selection of divisions, valid for all other series.

**SERIE 135 2**

CAJON 135 S100 C150 Hf  
TIROIR  
DRAWER

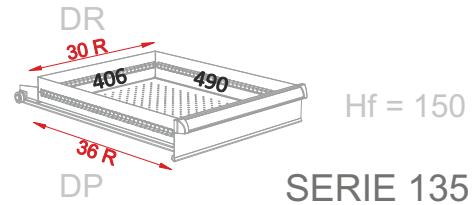

**DR** División ranurada. / **DP** Divisiones planas.  
Séparation rainurée. / Intercalaires.  
Slotted division. / Simple divisions.

**SERIE 135**

**DR** división ranurada séparations rainurées / slotted divisions

Longitud cajón: 406mm. Para tener 5 espacios, debo pedir 4 divisiones ranuradas.  
Longueur tiroir: 406mm. Pour avoir 5 espaces, je dois demander 4 divisions rainurées.  
Drawer length: 406mm. To have 5 spaces, I must ask 4 slotted divisors.

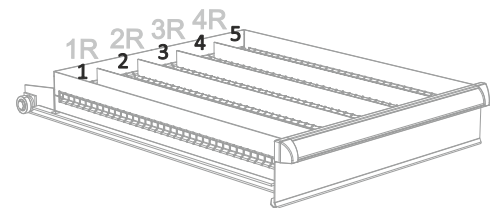

**SERIE** + **Hf** Altura frontal. Hauteur frontale. Front height. + **R**

**DP** división plana intercalaires / simple division

Para tener 25 espacios, debo pedir 20 divisiones planas.  
Pour avoir 25 espaces, je dois demander 20 séparations intercalaires.  
To have to 25 spaces, I must be ask 20 simple divisions.

$4 \times 5 = 20$  unidades unités units  $\frac{30R}{5}$  espacios places space = R 06

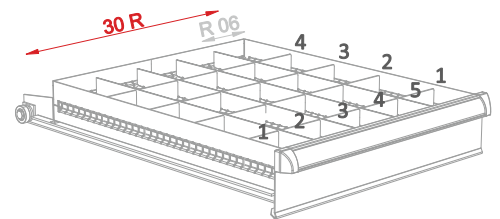

**Hf** Altura frontal. Hauteur frontale. Front height. + **R**

<b>PEDIDO</b>	<b>SERIE 135 2</b>	cajón tiroir / drawer
<b>COMMANDE</b>	1u. 135 S100 C150	división ranurada division rainurée / slotted division <b>DR</b>
<b>ORDER</b>	4u. 135 150 R	división plana intercalaire / simple division <b>DP</b>
	20u. 150 06	

**DR** posición position / position

Ubicación de las divisiones ranuradas y las divisiones planas.  
Emplacement pour les divisions rainurées et les intercalaires.  
Slotted and simple divisions emplacement.

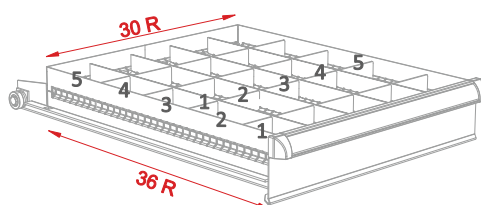

**DR**  $\frac{30R}{5}$  espacios places space = 6 ranuras ocupadas en horizontal rainures occupées longitudinales longitudinal occupied grooves

**DP**  $\frac{36R}{5}$  espacios places space = 7 ranuras ocupadas en vertical rainures occupées verticales vertical occupied grooves

## SERIE 115 -126-127 COMPOSICIONES / COMPOSITIONS / COMPOSITIONS

Divisiones para cajones según altura frontal.  
Séparateurs des tiroirs selon hauteur de frontal.  
Drawer divisions according to front height.

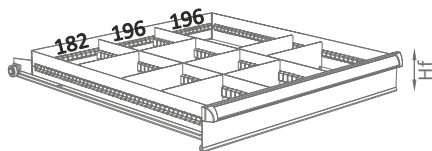

	Hf
115 050 D1	50
115 075 D1	75
115 100 D1	100
115 125 D1	125
115 150 D1	150
115 200 D1	200
115 250 D1	250

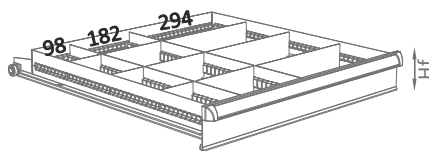

	Hf
115 050 D2	50
115 075 D2	75
115 100 D2	100
115 125 D2	125
115 150 D2	150
115 200 D2	200
115 250 D2	250

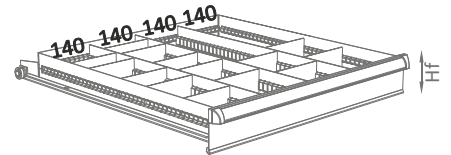

	Hf
115 050 D3	50
115 075 D3	75
115 100 D3	100
115 125 D3	125
115 150 D3	150
115 200 D3	200
115 250 D3	250

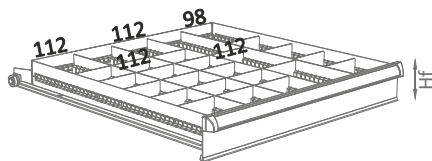

	Hf
115 050 D4	50
115 075 D4	75
115 100 D4	100
115 125 D4	125
115 150 D4	150
115 200 D4	200
115 250 D4	250

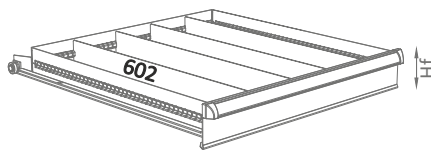

	Hf
115 050 D5	50
115 075 D5	75
115 100 D5	100
115 125 D5	125
115 150 D5	150
115 200 D5	200
115 250 D5	250

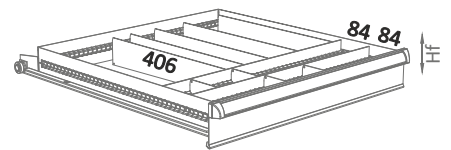

	Hf
115 050 D6	50
115 075 D6	75
115 100 D6	100
115 125 D6	125
115 150 D6	150
115 200 D6	200
115 250 D6	250

## SERIE 115 -126-127 COMPOSICIONES / COMPOSITIONS / COMPOSITIONS

Cubetas para cajones según altura frontal, sólo cajón 75 y 100.  
Boîtes des tiroirs selon hauteur de frontal, tiroir 75 et 100 seulement.  
Drawer trays according to front height, drawer 75 and 100 only.

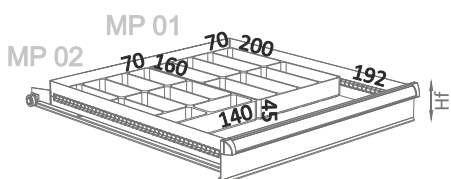

	Hf	cubetas boîtes trays
115 MP 01-02	75	MP 01
115 MP 01-02	100	MP 02

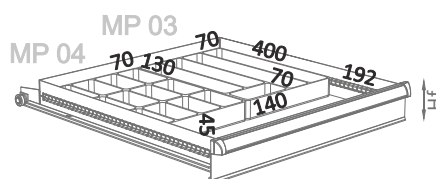

	Hf	cubetas boîtes trays
115 MP 03-04	75	MP 03
115 MP 03-04	100	MP 04

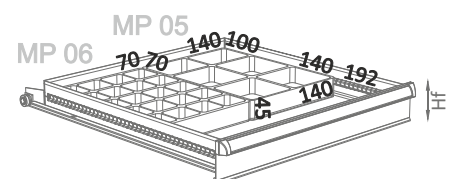

	Hf	cubetas boîtes trays
115 MP 05-06	75	MP 05
115 MP 05-06	100	MP 06

SERIE 115 -126-127 COMPOSICIONES / COMPOSITIONS / COMPOSITIONS

Cubetas para cajones según altura frontal.  
Boîtes des tiroirs selon hauteur de frontal.  
Drawer trays according to front height.

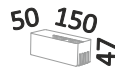

48x CPA 01  
48x CPA 01 1

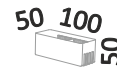

24x CPA 00  
24x 200 2 02

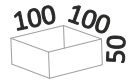

24x CPA 02

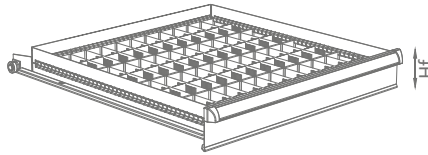

	Hf	cubetas boîtes trays
115 075 C1	75	48x CPA 01
	100	48x CPA 01 1

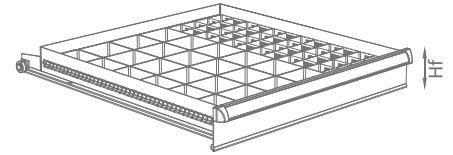

	Hf	cubetas boîtes trays
115 075 C2	75	24x CPA 00
	100	24x 200 2 02
		24x CPA 02

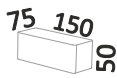

16x CPA 04

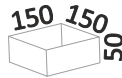

8x CPA 05



8x CPA 10

4x CPA 11

4x CPA 12

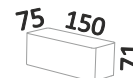

24x CP C 04



4x CP C 05

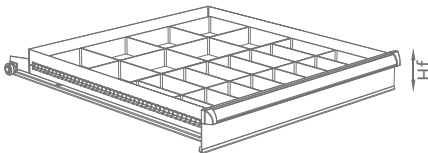

	Hf	cubetas boîtes trays
115 075 C3	75	16x CPA 04
	100	8x CPA 05

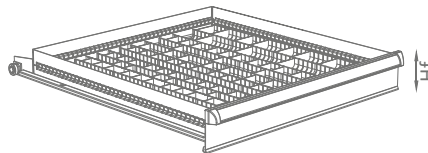

	Hf	cubetas boîtes trays
115 075 C4	75	8x CPA 10
	100	4x CPA 11
		4x CPA 12

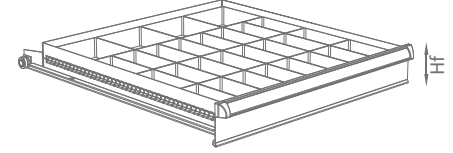

	Hf	cubetas boîtes trays
115 125 C1	125	4x CP C 05
	150	24x CP C 04

SERIE 119 COMPOSICIONES / COMPOSITIONS / COMPOSITIONS

Divisiones para cajones según altura frontal.  
Séparateurs des tiroirs selon hauteur de frontal.  
Drawer divisions according to front height.

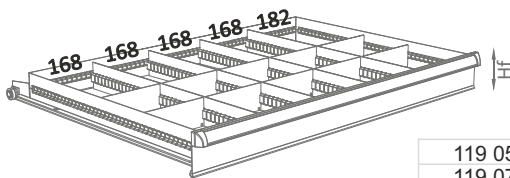

	Hf
119 050 D3	50
119 075 D3	75
119 100 D3	100
119 125 D3	125
119 150 D3	150
119 200 D3	200
119 250 D3	250

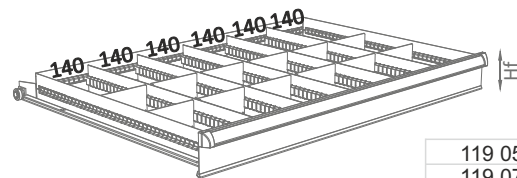

	Hf
119 050 D4	50
119 075 D4	75
119 100 D4	100
119 125 D4	125
119 150 D4	150
119 200 D4	200
119 250 D4	250

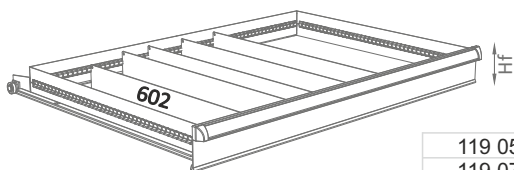

	Hf
119 050 D5	50
119 075 D5	75
119 100 D5	100
119 125 D5	125
119 150 D5	150
119 200 D5	200
119 250 D5	250

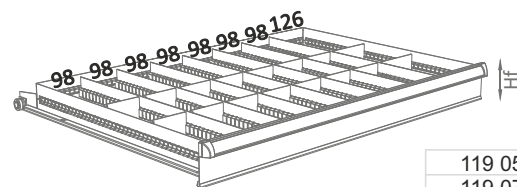

	Hf
119 050 D6	50
119 075 D6	75
119 100 D6	100
119 125 D6	125
119 150 D6	150
119 200 D6	200
119 250 D6	250

## SERIE 119 COMPOSICIONES / COMPOSITIONS / COMPOSITIONS

Cubetas para cajones según altura frontal, sólo cajón 75 y 100.  
Boîtes des tiroirs selon hauteur de frontal, tiroir 75 et 100 seulement.  
Drawer trays according to front height, drawer 75 and 100 only.

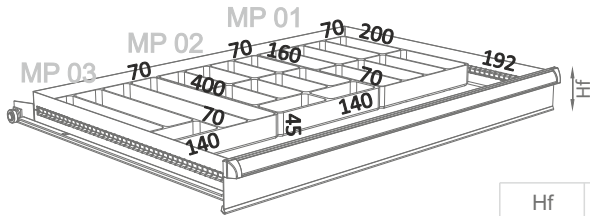

119 MP 01-02-03	Hf	cubetas boîtes trays
	75	MP 01 MP 02 MP 03
100		

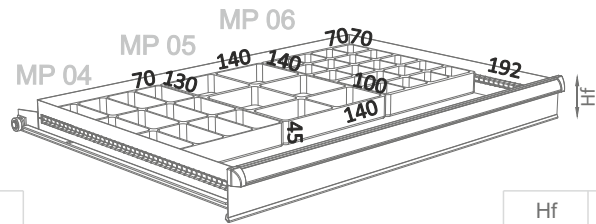

119 MP 04-05-06	Hf	cubetas boîtes trays
	75	MP 04 MP 05 MP 06
100		

## SERIE 122 COMPOSICIONES / COMPOSITIONS / COMPOSITIONS

Divisiones para cajones según altura frontal.  
Séparateurs des tiroirs selon hauteur de frontal.  
Drawer divisions according to front height.

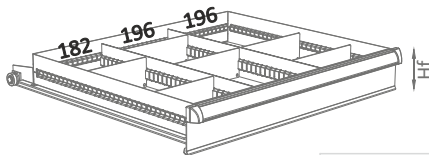

	Hf
122 075 D1	75
122 100 D1	100
122 125 D1	125
122 150 D1	150
122 200 D1	200
122 250 D1	250

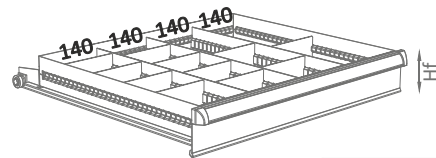

	Hf
122 075 D2	75
122 100 D2	100
122 125 D2	125
122 150 D2	150
122 200 D2	200
122 250 D2	250

## SERIE 123 COMPOSICIONES / COMPOSITIONS / COMPOSITIONS

Divisiones para cajones según altura frontal.  
Séparateurs des tiroirs selon hauteur de frontal.  
Drawer divisions according to front height.

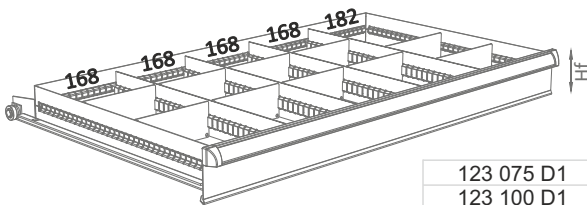

	Hf
123 075 D1	75
123 100 D1	100
123 125 D1	125
123 150 D1	150
123 200 D1	200
123 250 D1	250

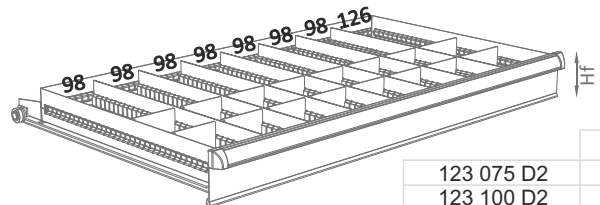

	Hf
123 075 D2	75
123 100 D2	100
123 125 D2	125
123 150 D2	150
123 200 D2	200
123 250 D2	250

## SERIE 135 COMPOSICIONES / COMPOSITIONS / COMPOSITIONS

Divisiones para cajones según altura frontal.  
Séparateurs des tiroirs selon hauteur de frontal.  
Drawer divisions according to front height.

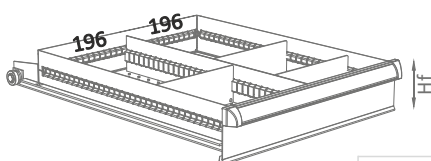

	Hf
135 075 D1	75
135 100 D1	100
135 125 D1	125
135 150 D1	150
135 200 D1	200
135 250 D1	250

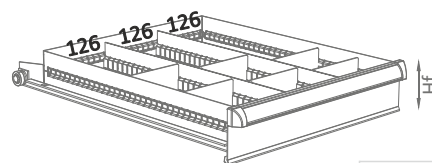

	Hf
135 075 D2	75
135 100 D2	100
135 125 D2	125
135 150 D2	150
135 200 D2	200
135 250 D2	250



SERIE 143 COMPOSICIONES / COMPOSITIONS / COMPOSITIONS

Divisiones para cajones según altura frontal.  
Séparateurs des tiroirs selon hauteur de frontal.  
Drawer divisions according to front height.

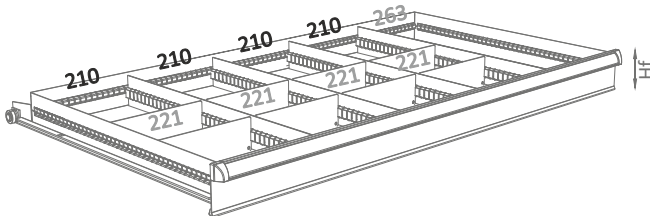

	Hf
143 075 D3	75
143 100 D3	100
143 125 D3	125
143 150 D3	150
143 200 D3	200
143 250 D3	250

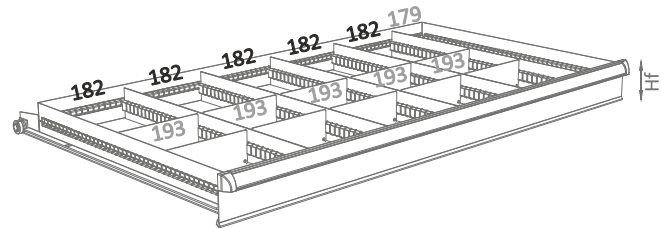

	Hf
143 075 D4	75
143 100 D4	100
143 125 D4	125
143 150 D4	150
143 200 D4	200
143 250 D4	250

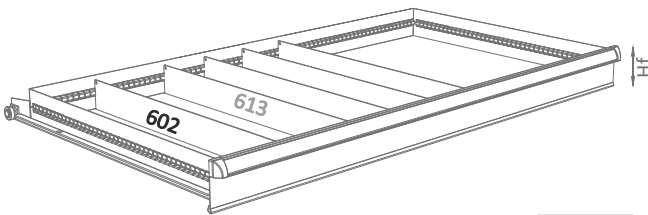

	Hf
143 075 D5	75
143 100 D5	100
143 125 D5	125
143 150 D5	150
143 200 D5	200
143 250 D5	250

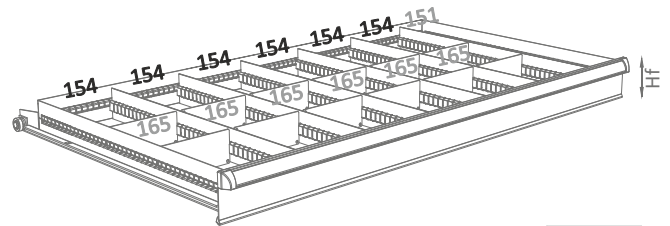

	Hf
143 075 D6	75
143 100 D6	100
143 125 D6	125
143 150 D6	150
143 200 D6	200
143 250 D6	250

SERIE 143 COMPOSICIONES / COMPOSITIONS / COMPOSITIONS

Cubetas para cajones según altura frontal, sólo cajón 75 y 100.  
Boîtes des tiroirs selon hauteur de frontal, tiroir 75 et 100 seulement.  
Drawer trays according to front height, drawer 75 and 100 only.

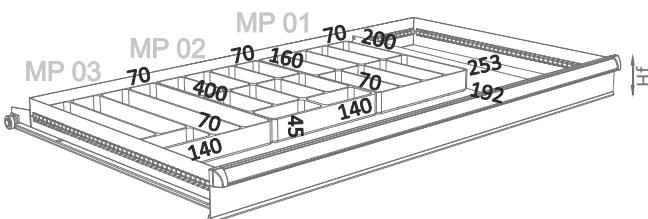

	Hf	cubetas boîtes trays
143 MP 01-02-03	75	MP 01
	100	MP 02
		MP 03

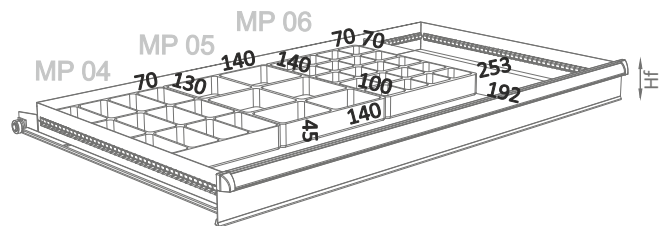

	Hf	cubetas boîtes trays
143 MP 04-05-06	75	MP 04
	100	MP 05
		MP 06

