

ARMOIRES A PORTES

CABINETS WITH DOORS



FR

- Grande variété de tailles et configurations.
- Conception robuste et résistante.
- Ouverture des portes à 180°.
- Fermeture à deux points.
- Étagères réglables chaque 25mm.
- Portes en option de méthacrylate.
- Système RFID en option.
- Délai de livraison 10 jours ouvrables.
- Couleur standard bleu martelé possibilité teintes en option.

EN

- Wide range of sizes and configurations.
- Strong and resistant design.
- 180° Opening doors.
- 2 point closure.
- Adjustable shelves every 25mm.
- Methacrylate doors in option.
- Optional RFID system.
- Delivery time 10 working days.
- Standard colour hammered blue possibility optional colours.



SERIE 125 ref. 1251 / 125 2

Armario 2 puertas
Armoire 2 portes
Cabinet with 2 doors



SERIE 125 1

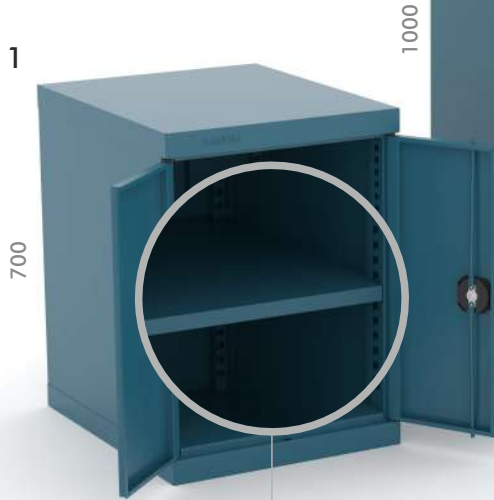

SERIE 125 2

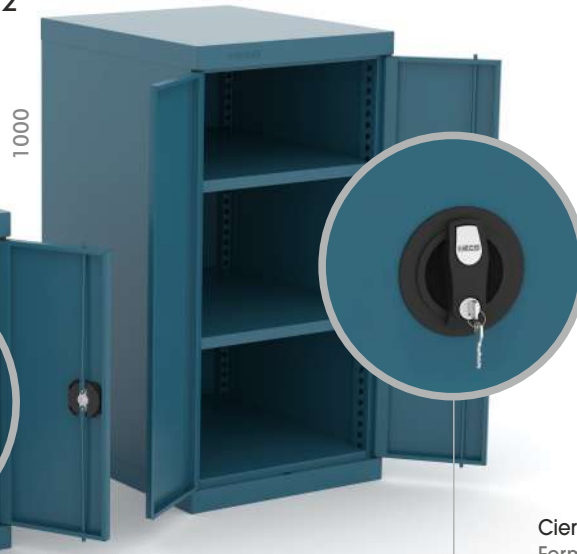

Cierre con llave.
Fermeture à clé.
Key Locking.

Bandejas regulables cada 25mm
Plateaux réglables chaque 25mm
Adjustable shelves every 25mm

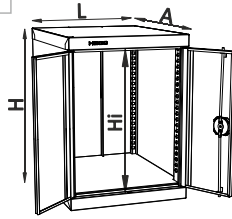

	LxAxH (mm)	Hi (mm)	Bandejas/Plateaux/Trays
125 1	515x623x700	600	1 (500x500x20)
125 2	515x623x1000	900	2 (500x500x20)

*armazón chasis / frame

1 mm

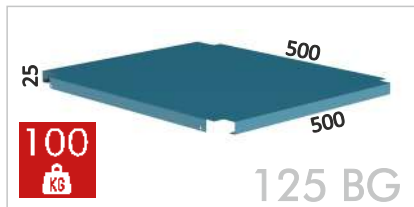

125 BG



Opcional. Ver: PAG 291.
Optionnel. Voir: PAG 291.
Optional. See: PAGE 291.



Accesorio: estanteria 125 BG, graduable cada 25mm.
Accessoire: étagère 125 BG, réglable chaque 25mm.
Accessory: shelf 125 BG, adjustable every 25mm.

SERIE 125 1 STANDARD

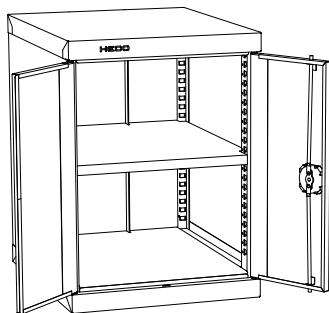

	Bandejas/Plateaux/Trays	
125 1	38 Kg	1x 125 BG

SERIE 125 2 STANDARD

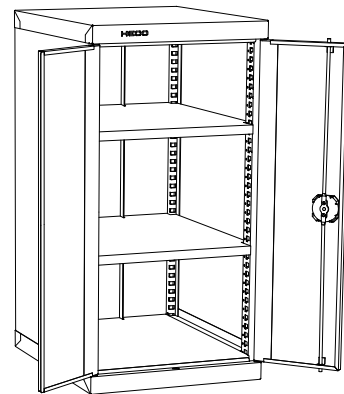

	Bandejas/Plateaux/Trays	
125 2	47 Kg	2x 125 BG

SERIE 126

ref. 126 1 / 126 2 / 126 4

Armario 2 puertas
Armoire 2 portes
Cabinet with 2 doors



Cierre con llave.
Fermeture à clé.
Key Locking.

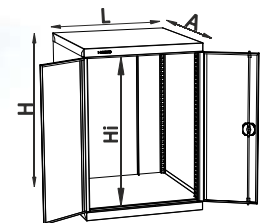

		L x A x H	Hi (mm)
126 1	41 Kg	714x730x700	575
126 2	49 Kg	714x730x1000	875
126 4	55 Kg	714x730x1400	1275

*armazón chasis / frame

e 1 mm



Opcional. Ver: PAG 291.
Optionnel. Voir: PAG 291.
Optional. See: PAGE 291.



Estanterías graduables cada 25mm.
Étagères réglables chaque 25mm.
Adjustable shelves every 25mm.



Complete su armario con cajones, estanterías y bandejas.
Compléter votre armoire avec des tiroirs, des étagères et plateaux.
Complete your cabinet with drawers, shelves and trays.

INFO

ESTANTERIAS Y CAJONES / ÉTAGÈRES ET TIROIRS / SHELVES AND DRAWERS

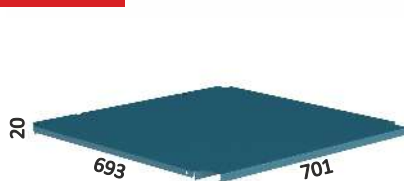

126 BG

4,6 Kg



estantería graduable
étagère réglable
adjustable shelf



127 BE T100



bandeja extraíble
plateau amovible
removable tray



127 BE T200



bandeja extraíble
plateau amovible
removable tray



127 T200 50



Cajón con 25 Porta Conos ISO 50
Tiroir avec 25 Porte-Cônes ISO 50
Drawer with 25 Tool-Holder ISO 50



127 T200 40



Cajón con 25 Porta Conos ISO 40
Tiroir avec 25 Porte-Cônes ISO 40
Drawer with 25 Tool-Holder ISO 40

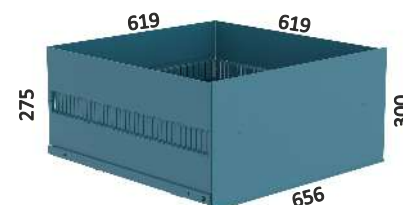

127 T100 300

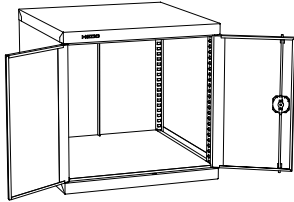

Cajón
Tiroir
Drawer

SERIE 126 1 STANDARD

		L x A x H
126 1	41 Kg	714 x 730 x 700

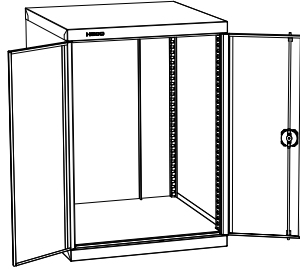
SERIE 126 2 STANDARD

		L x A x H
126 2	49 Kg	714 x 730 x 1000

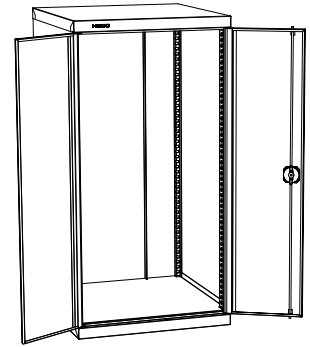
SERIE 126 4 STANDARD

		L x A x H
126 4	55 Kg	714 x 730 x 1400

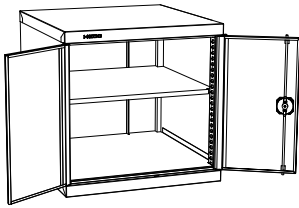
SERIE 126 1 STANDARD

		L x A x H
126 1 1	42.5 Kg	714 x 730 x 700

componentes / composants / components	
126 BG	* estanteria / étagère / shelf * graduable / réglable / adjustable

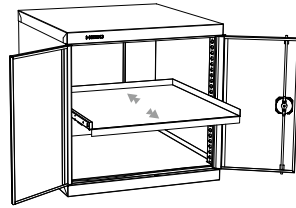

		L x A x H
126 1 2	51 Kg	714 x 730 x 700

componentes / composants / components	
127 BE T100	* bandeja / plateau / tray
	* extraíble / amovible / removable

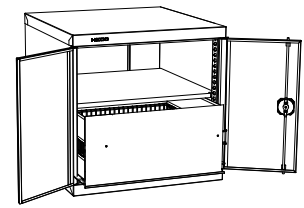

		L x A x H
126 1 3	67.5 Kg	714 x 730 x 700

componentes / composants / components	
126 BG	* estanteria / étagère / shelf
127 T100 300	cajón / tiroir / drawer
	* graduable / réglable / adjustable

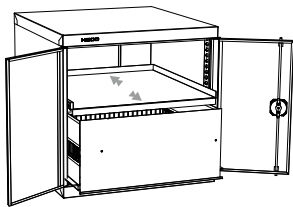

		L x A x H
126 1 4	76 Kg	714 x 730 x 700

componentes / composants / components	
127 BE T100	* bandeja / plateau / tray
127 T100 300	cajón / tiroir / drawer
	* extraíble / amovible / removable

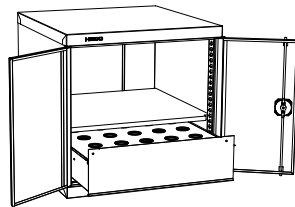

		L x A x H
126 1 5	65.5 Kg	714 x 730 x 700

componentes / composants / components	
126 BG	* estanteria / étagère / shelf
127 T200 50	cajón / tiroir / drawer
	* graduable / réglable / adjustable
	porta-conos / porte-cônes / tool support ISO 50 / ISO 50 / ISO 50

25u. PC ISO 50

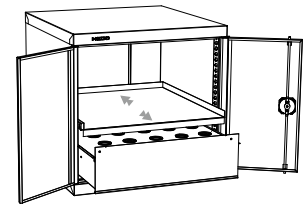

		L x A x H
126 1 6	74 Kg	714 x 730 x 700

componentes / composants / components	
127 BE T100	* bandeja / plateau / tray
127 T200 50	cajón / tiroir / drawer
	* extraíble / amovible / removable
	porta-conos / porte-cônes / tool support ISO 50 / ISO 50 / ISO 50

25u. PC ISO 50

SERIE 126 2 STANDARD

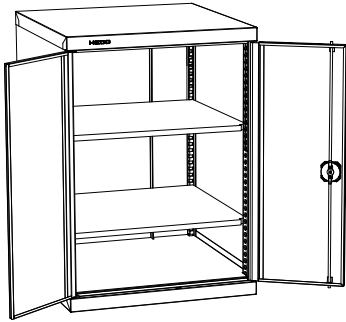

		L x A x H
126 2 1	52 Kg	714 x 730 x 1000
componentes / composants / components		
2x 126 BG	* estanteria / étagère / shelf	
* graduable / réglable / adjustable		

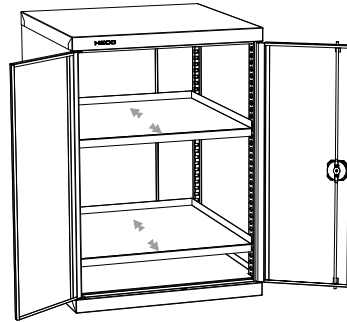

		L x A x H
126 2 2	69 Kg	714 x 730 x 1000
componentes / composants / components		
2x 127 BE T100	* bandeja / plateau / tray	
* extraíble / amovible / removable		

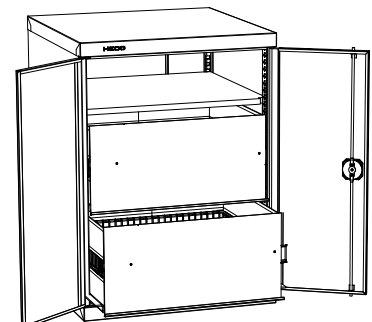

		L x A x H
126 2 3	100 Kg	714 x 730 x 1000
componentes / composants / components		
1x 126 BG	* estanteria / étagère / shelf	
2x 127 T100 300	cajón / tiroir / drawer	
* graduable / réglable / adjustable		

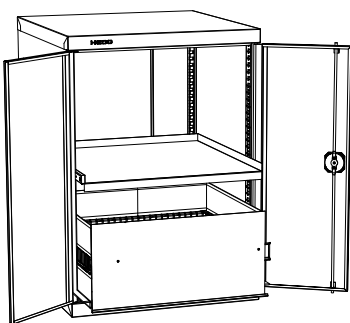

		L x A x H
126 2 4	84 Kg	714 x 730 x 1000
componentes / composants / components		
1x 127 BE T100	* bandeja / plateau / tray	
1x 127 T100 300	cajón / tiroir / drawer	
* graduable / réglable / adjustable		

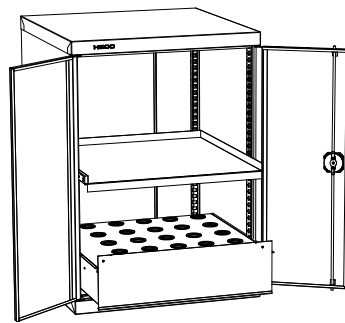

		L x A x H
126 2 5	82 Kg	714 x 730 x 1000
componentes / composants / components		
1x 127 BE T100	* bandeja / plateau / tray	
127 T200 50	cajón / tiroir / drawer	
* extraíble / amovible / removable		
porta-conos / porte-cônes / tool support ISO 50 / ISO 50 / ISO 50		

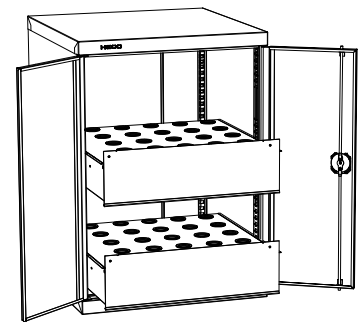

		L x A x H
126 2 6	98 Kg	714 x 730 x 1000
componentes / composants / components		
1x 127 T200 40	cajón / tiroir / drawer	
1x 127 T200 50	cajón / tiroir / drawer	
porta-conos / porte-cônes / tool support ISO 40-50 / ISO 40-50 / ISO 40-50		

SERIE 126 4 STANDARD

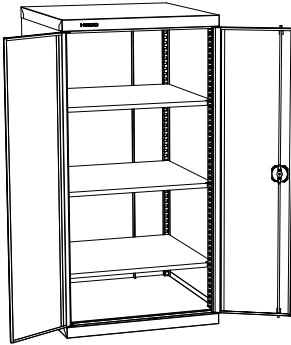

		L x A x H
126 4 1	59.5 Kg	714 x 730 x 1400

componentes / composants / composants		
3x 126 BG	* estanteria / étagère / shelf	
* graduable / réglable / adjustable		

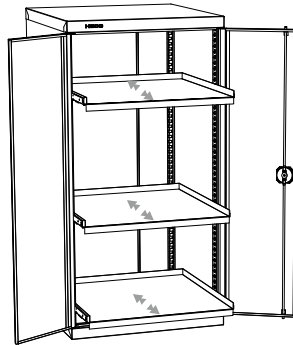

		L x A x H
126 4 2	85 Kg	714 x 730 x 1400

componentes / composants / composants		
3x 127 BE T100	* bandeja / plateau / tray	
* extraíble / amovible / removable		

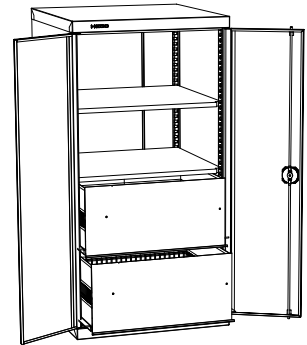

		L x A x H
126 4 3	108 Kg	714 x 730 x 1400

componentes / composants / composants		
2x 126 BG	* estanteria / étagère / shelf	
2x 127 T100 300	cajón / tiroir / drawer	
* graduable / réglable / adjustable		

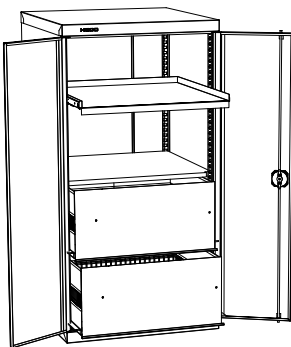

		L x A x H
126 4 4	116.5 Kg	714 x 730 x 1400

componentes / composants / composants		
1x 127 BE T100	* bandeja / plateau / tray	
1x 126 BG	* estanteria / étagère / shelf	
2x 127 T100 300	cajón / tiroir / drawer	
* extraíble / amovible / removable		
* graduable / réglable / adjustable		

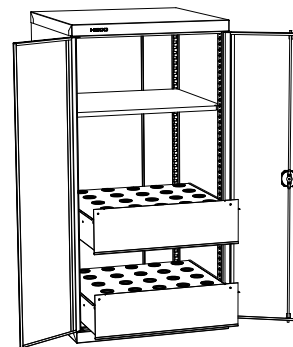

25u. PC ISO 40
25u. PC ISO 50

		L x A x H
126 4 5	99.5 Kg	714 x 730 x 1400

componentes / composants / composants		
1x 126 BG	* estanteria / étagère / shelf	
1x 127 T200 40	cajón / tiroir / drawer	
1x 127 T200 50	cajón / tiroir / drawer	
* graduable / réglable / adjustable		
porta-conos / porte-cônes / tool support ISO 40-50 / ISO 40-50 / ISO 40-50		

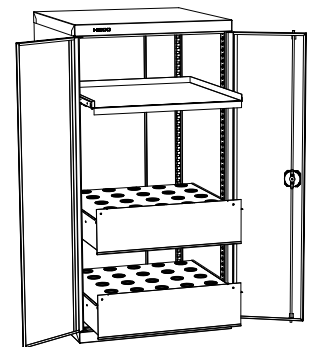

25u. PC ISO 40
25u. PC ISO 50

		L x A x H
126 4 6	108 Kg	714 x 730 x 1400

componentes / composants / composants		
1x 127 BE T100	* bandeja / plateau / tray	
1x 127 T200 40	cajón / tiroir / drawer	
1x 127 T200 50	cajón / tiroir / drawer	
* extraíble / amovible / removable		
porta-conos / porte-cônes / tool support ISO 40-50 / ISO 40-50 / ISO 40-50		

SERIE 136 1 ref. 136 1

Armarios con puertas y estanterías.
Armoires avec portes et étagères.
Cabinets with doors and shelves.



SERIE 136 1



Cierre con llave.
Fermeture à clé.
Key Locking.

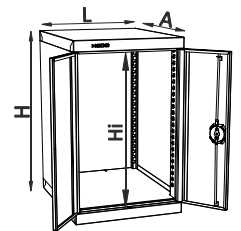

Opcional. Ver: PAG 291.
Optionnel. Voir: PAG 291.
Optional. See: PAGE 291.



Estanterías graduables en altura cada 25mm.
Étagères réglables en hauteur chaque 25mm.
Adjustable shelves in height every 25mm.

136 1	28 Kg		L x A x H	Hi (mm)
		41 Kg	515x600x830	750

*armazón chasis / frame

1 mm

SERIE 136 1 STANDARD

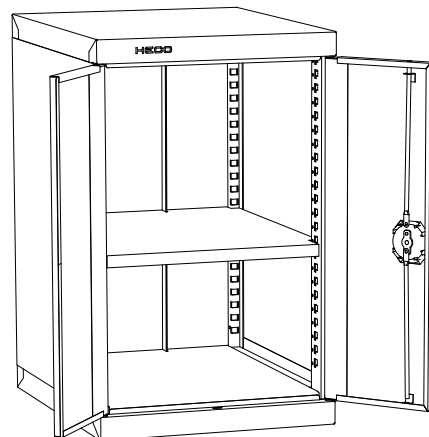

136 1	41 Kg	L x A x H
		515 x 600 x 830

componentes / composants / components	
1x 125 BG	bandeja / plateau / tray



Estanterías graduables cada 25mm.
Étagères réglables chaque 25mm.
Adjustable shelves every 25mm.

SERIE 154 ref. 154 0 / 154 1 / 154 2 / 154 3 / 154 4 / 154 5

Pupitres y armarios bajos.
Pupitre et armoires basses.
Desk and low cabinets.



Goma estriada (0/1/3).
Caoutchouc strié (0/1/3).
Striated rubber (0/1/3).

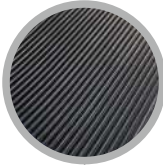

SERIE 154 4
SERIE 154 5

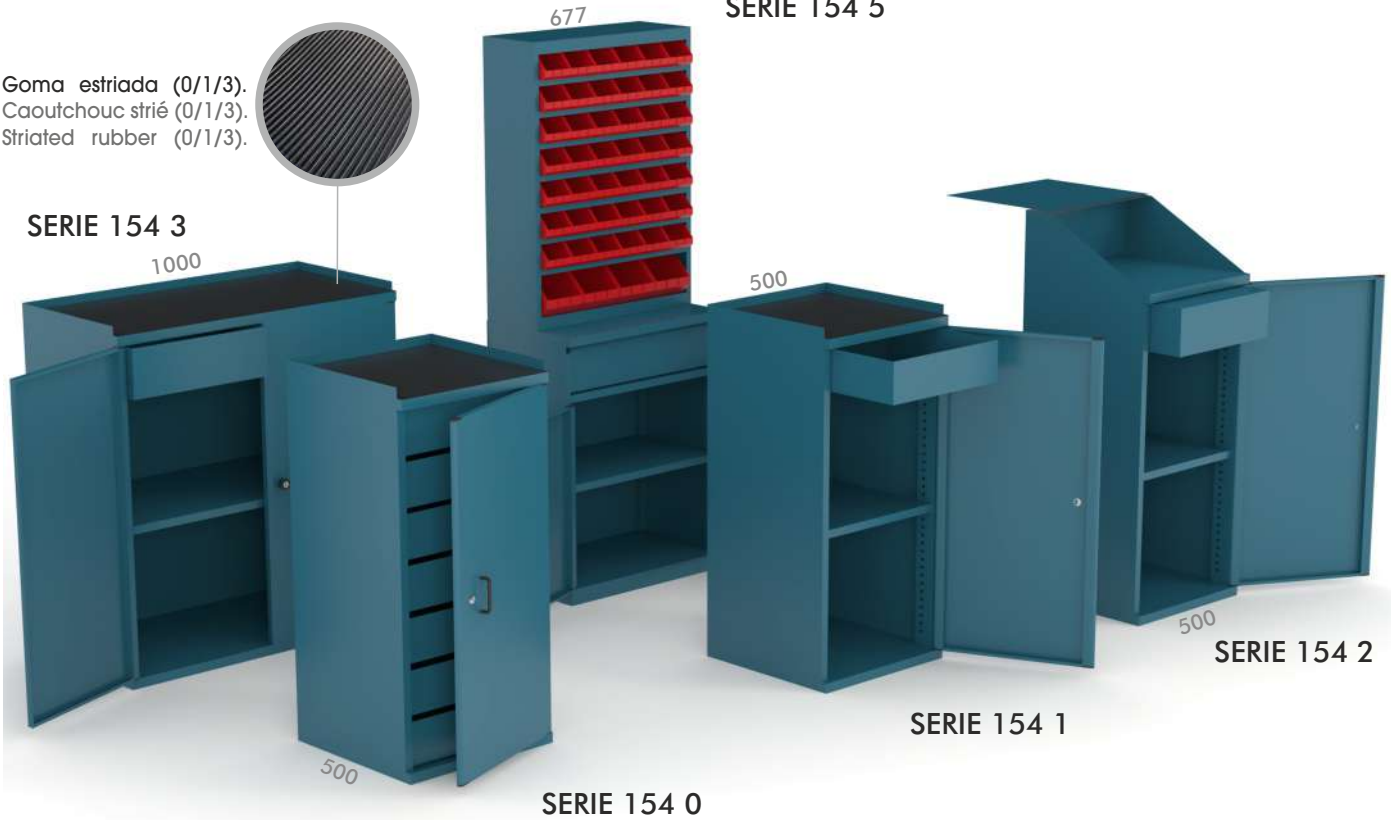

154 1/2 154 3/5

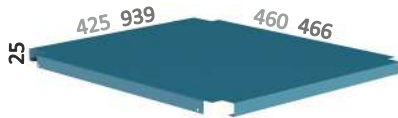

Estanterías graduables cada 25mm.
Étagères réglables chaque 25mm.
Adjustable shelves every 25mm.



Carga máxima repartida 100 Kg.
Charge maximum répartie 100 Kg.
Maximum distributed load 100 Kg.

CAJÓN TIROIR / DRAWER

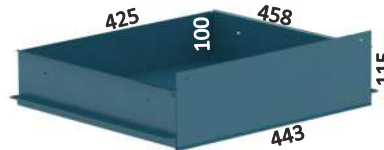

Carga máxima repartida 15 Kg.
Charge maximum répartie 15 Kg.
Maximum distributed load 15 Kg.

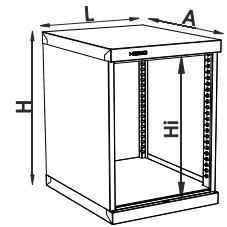

154 R

x2



Ruedas de nylon Ø = 100 mm.
Roues de nylon Ø = 100 mm.
Nylon wheels Ø = 100 mm.

	L x A x H	Hi (mm)	Ref.	L x A x H	Ref.	L x A x H
154 0	500x500x1050	970	154 0 P	500x500x1125	154 0 R	500x500x1185
154 1	500x500x1050	970	154 1 P	500x500x1125	154 1 R	500x500x1185
154 2	500x500x1250	970	154 2 P	500x500x1325	154 2 R	500x500x1385
154 3	1000x500x1050	970	154 3 P	1000x500x1125	154 3 R	1000x500x1185

154 P: Con pies. Avec pieds. With stands.
154 R: Con ruedas. Avec roues. With wheels.

e 1 mm



154 0, 154 1 y 154 3: Con goma sintética.
154 0, 154 1 et 154 3: Avec gomme synthétique.
154 0, 154 1 and 154 3: With synthetic rubber.

	L x A x H	Hi (mm)
154 4	677x246x913	830
154 5	677x400x850	580

SERIE 154 0 STANDARD

7 cajones con guía simple - hasta 15Kg repartidos / 7 tiroirs avec glissière simple - jusqu'à 15K réparties / 7 drawers with simple slide - up to distributed 15Kg

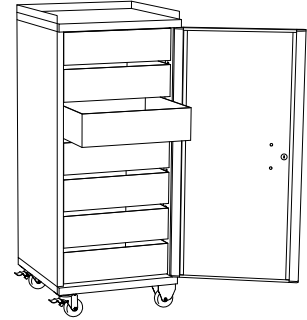
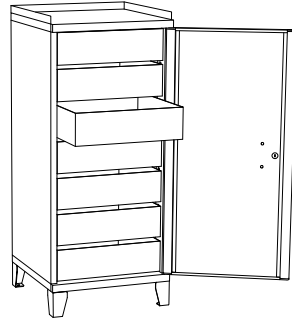
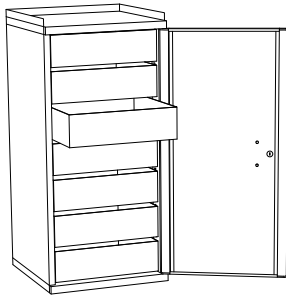

		L x A x H
154 0	64 Kg	500 x 500 x 1050

		L x A x H
154 0 P	65 Kg	500 x 500 x 1125

		L x A x H
154 0 R	75 Kg	500 x 500 x 1185

SERIE 154 1 STANDARD

1 estanteria graduable con 1 cajón / 1 étagère réglable avec 1 tiroir / 1 adjustable shelf with 1 drawer

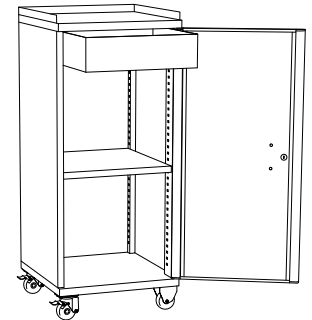
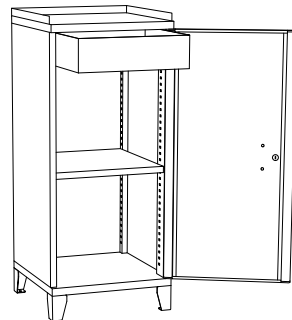
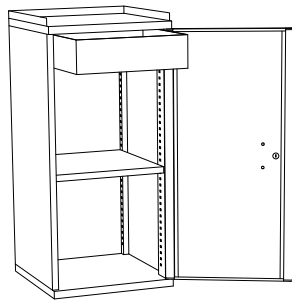

		L x A x H
154 1	35 Kg	500 x 500 x 1050

		L x A x H
154 1 P	36 Kg	500 x 500 x 1125

		L x A x H
154 1 R	46 Kg	500 x 500 x 1185

accesorios / accessoires / accessories	
154 1 01	bandeja / plateau / tray

accesorios / accessoires / accessories	
154 1 01	bandeja / plateau / tray

accesorios / accessoires / accessories	
154 1 01	bandeja / plateau / tray

SERIE 154 2 STANDARD

1 estanteria graduable con 1 cajón y compartimento suplementario.
1 étagère réglable avec 1 tiroir et compartiment supplémentaire.
1 adjustable shelf with 1 drawer and extra compartment.

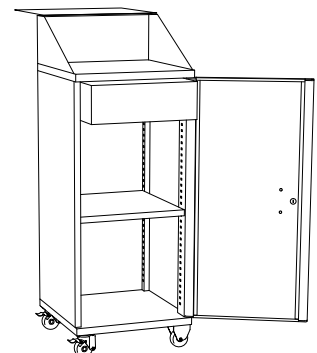
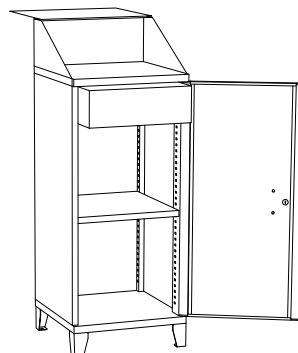
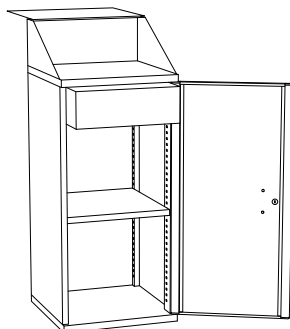

		L x A x H
154 2	37 Kg	500 x 500 x 1250

		L x A x H
154 2 P	38 Kg	500 x 500 x 1325

		L x A x H
154 2 R	48 Kg	500 x 500 x 1385

accesorios / accessoires / accessories	
154 1 01	bandeja / plateau / tray

accesorios / accessoires / accessories	
154 1 01	bandeja / plateau / tray

accesorios / accessoires / accessories	
154 1 01	bandeja / plateau / tray

SERIE 154 3 STANDARD

1 estantería graduable con 2 cajones / 1 étagère réglable avec 2 tiroirs / 1 adjustable shelf with 2 drawers.

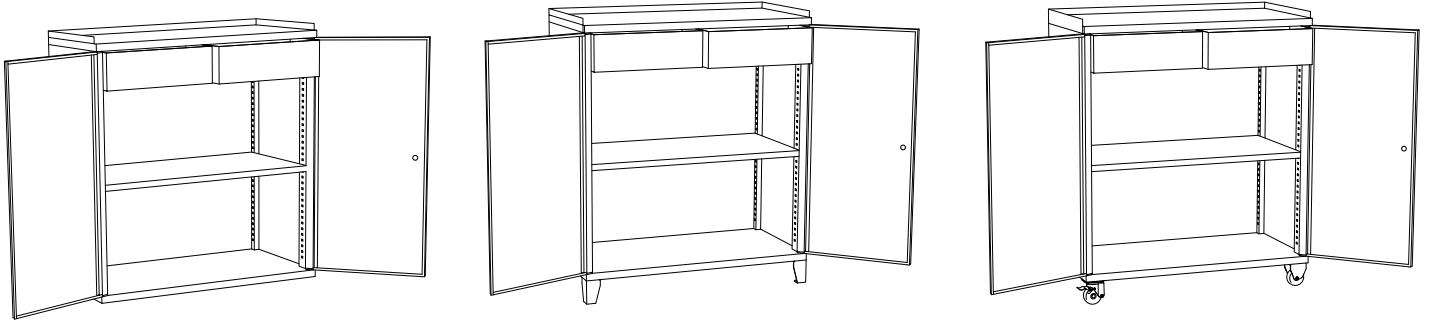

L x A x H		
154 3	50 Kg	1000 x 500 x 1050
accesorios / accessoires / accessories		
154 3 01	bandeja / plateau / tray	

L x A x H		
154 3 P	52 Kg	1000 x 500 x 1125
accesorios / accessoires / accessories		
154 3 01	bandeja / plateau / tray	

L x A x H		
154 3 R	63 Kg	1000 x 500 x 1185
accesorios / accessoires / accessories		
154 3 01	bandeja / plateau / tray	

SERIE 154 4 STANDARD

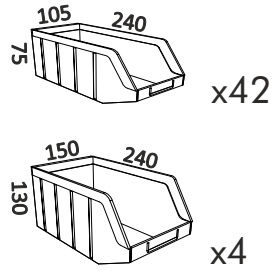
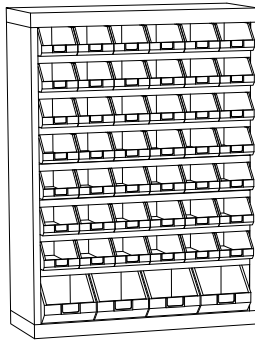

L x A x H		
154 4	35 Kg	679 x 248 x 913

e 0,8 mm



Permite fijación a pared.
Permet la fixation au mur.
It allows wall fixation.

SERIE 154 5 STANDARD

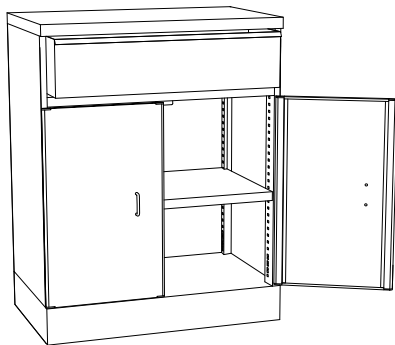

L x A x H		
154 5	32 Kg	679 x 400 x 850



Incluye cajón y estantería graduable. Cierre magnético.
Tiroir et étagère réglable inclus. Fermeture magnétique.
Drawer and adjustable shelf included. Magnetic lock.

SERIE 154 4 5 STANDARD

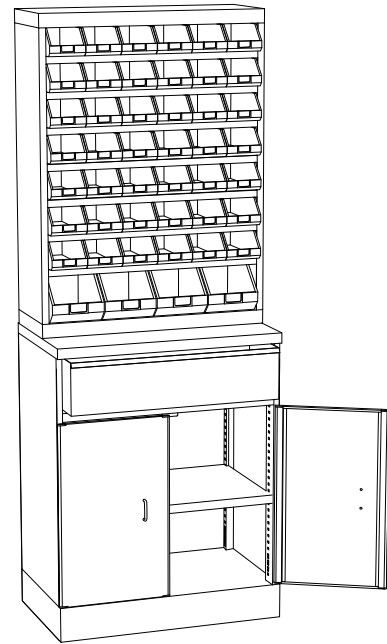

CAJÓN/TIROIR/DRAWER

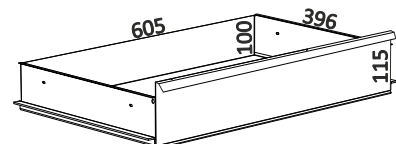

Carga máxima repartida 15 Kg.
Charge maximum répartie 15 Kg.
Maximum distributed load 15 Kg.

L x A x H		
154 4 5	67 Kg	677 x 400 x 1763



Incluye cajón y estantería graduable. Cierre magnético.
Tiroir et étagère réglable inclus. Fermeture magnétique.
Drawer and adjustable shelf included. Magnetic lock.

SERIE 157 ref. 157 1 - 157 12 / 157 2 P / 157 C

Armario 1 puerta
Armoire 1 porte
Cabinet with 1 door

SERIE 157

Cierre con llave.
Fermeture à clé.
Key Locking.

Apertura 180°.
Ouverture 180°.
Opening 180°.

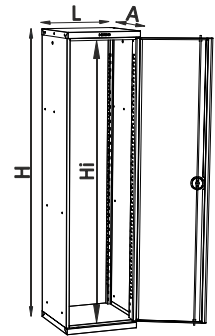
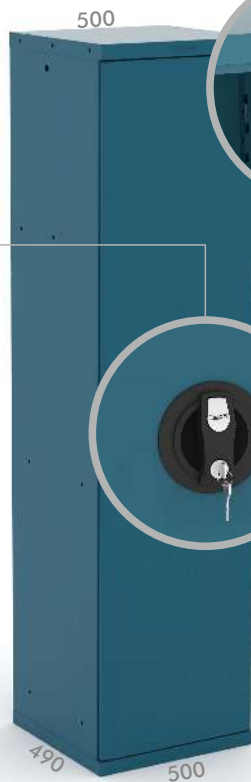

Opcional. Ver: PAG 291.
Optionnel. Voir: PAG 291.
Optional. See: PAGE 291.



Estanterías graduables cada 25mm.
Étagères réglables chaque 25mm.
Adjustable shelves every 25mm.

		L x A x H	Hi (mm)
157	40 Kg	500x490x1980	1865
157 2P	45 Kg	500x490x1980	2x 925
157 C	40 Kg	500x260x1980	1865

*armazón chasis / frame

e 1 mm

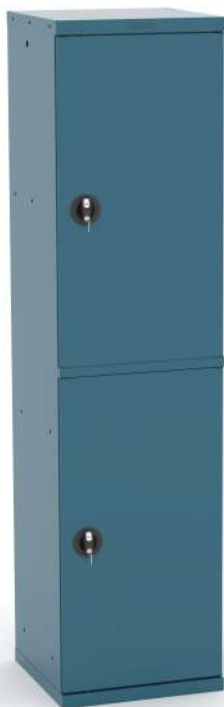

SERIE 157 C

Armario con soportes para cubetas V-BULL 1, 2, 3
Armoire avec supports pour bacs à bec V-BULL 1, 2, 3
Cabinet with V-BULL 1, 2, 3 tray supports.



ancho 260 mm.
profundeur 260 mm.
width 260 mm.

CAJÓN TIROIR / DRAWER

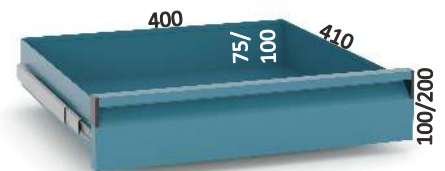

Carga máxima repartida 50 Kg. Apertura total.
Charge maximum répartie 50 Kg. Ouverture totale.
Maximum distributed load 50 Kg. Complete opening.



Opción puertas de metacrilato.
Option portes de méthacrylate.
Methacrylate doors option.



Accesorios (ver página 285).
Accessoires (voir page 285).
Accessories (see page 285).

SERIE 157 2P

Armario 2 puertas
Armoire 2 portes
Cabinet with 2 doors

SERIE 157 STANDARD

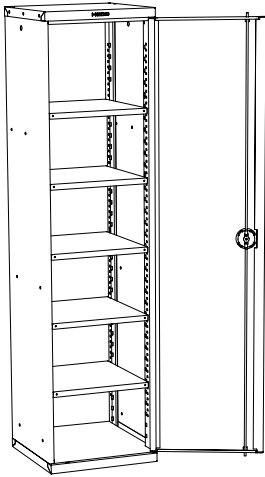

157 1	50 Kg	L x A x H 500 x 490 x 1980
-------	-------	-------------------------------

componentes / composants / components		
5x 157 BG	* estanteria / étagère / shelf	
* graduable / réglable / adjustable		

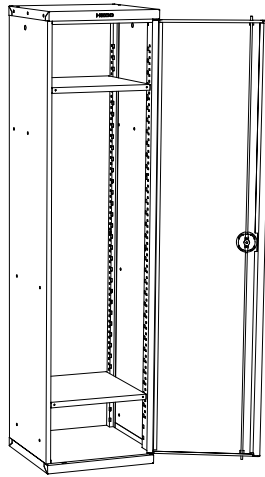

157 2	42 Kg	L x A x H 500 x 490 x 1980
-------	-------	-------------------------------

componentes / composants / components		
157 BG	* estanteria / étagère / shelf	
157 BP	* estanteria / étagère / shelf	
* graduable / réglable / adjustable		
para perchas / pour porte manteau / for coat rack		

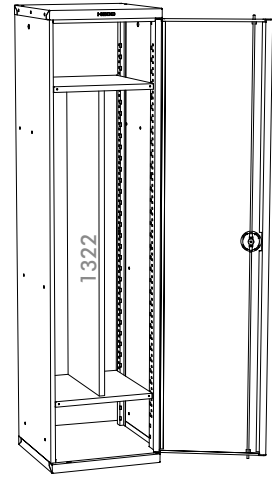

157 3	50 Kg	L x A x H 500 x 490 x 1980
-------	-------	-------------------------------

componentes / composants / components		
157 BG	* estanteria / étagère / shelf	
157 BP	* estanteria / étagère / shelf	
157 SC	separador / séparateur / separating	
* graduable / réglable / adjustable		
para perchas / pour porte manteau / for coat rack		

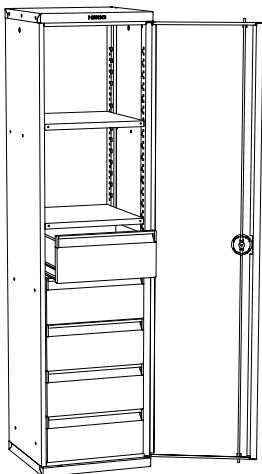

157 4	72.5 Kg	L x A x H 500 x 490 x 1980
-------	---------	-------------------------------

componentes / composants / components		
5x 157 T50 C200	cajón / tiroir / drawer	
2x 157 BG	* estanteria / étagère / shelf	
* graduable / réglable / adjustable		

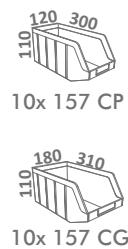
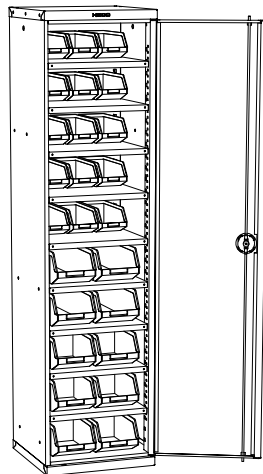

157 5	73 Kg	L x A x H 500 x 490 x 1980
-------	-------	-------------------------------

componentes / composants / components		
15x 157 CP	cubeta / bac à bec / tray	
9x 157 BG	* estanteria / étagère / shelf	
10x 157 TC	fin cubeta / cale bac à bec / block tray	
10x 157 CG	cubeta / bac à bec / tray	
* graduable / réglable / adjustable		

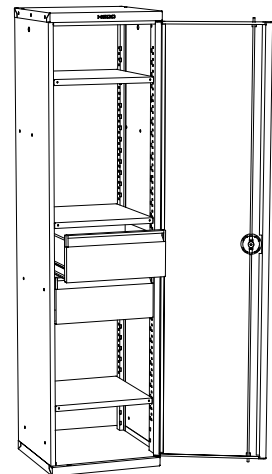

157 6	57 Kg	L x A x H 500 x 490 x 1980
-------	-------	-------------------------------

componentes / composants / components		
3x 157 BG	* estanteria / étagère / shelf	
2x 157 T50 C200	cajón / tiroir / drawer	
* graduable / réglable / adjustable		

SERIE 157 STANDARD

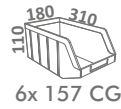
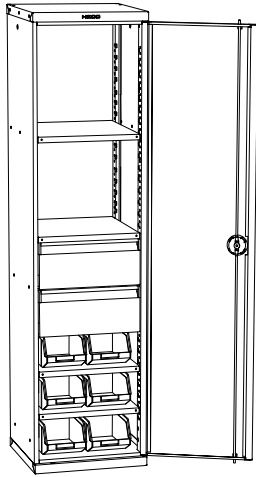

6x 157 CG

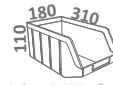
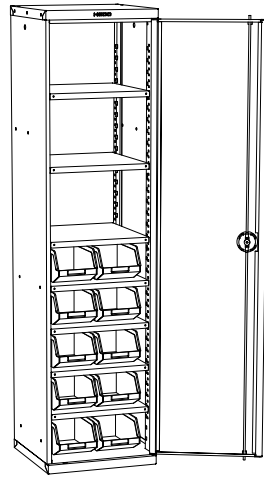

10x 157 CG

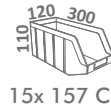

15x 157 CP

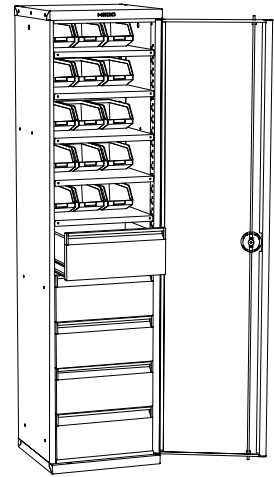

		L x A x H
157 7	47 Kg	500 x 490 x 1980

componentes / composants / composants

4x 157 BG * estanteria / étagère / shelf

6x 157 CG * cubeta / bac à bec / tray

2x 157 T50 C200 cajón / tiroir / drawer

* graduable / réglable / adjustable
* cubeta grande / bac à bec grand / big tray

		L x A x H
157 8	70 Kg	500 x 490 x 1980

componentes / composants / composants

7x 157 BG * estanteria / étagère / shelf

5x 157 TC fin cubeta / cale bac à bec / block tray

10x 157 CG * cubeta / bac à bec / tray

* graduable / réglable / adjustable
* cubeta grande / bac à bec grand / big tray

		L x A x H
157 9	54.5 Kg	500 x 490 x 1980

componentes / composants / composants

5x 157 BG * estanteria / étagère / shelf

15x 157 CP * cubeta / bac à bec / tray

5x 157 T50 C200 cajón / tiroir / drawer

* graduable / réglable / adjustable
* cubeta pequeña / bac à bec petit / small tray

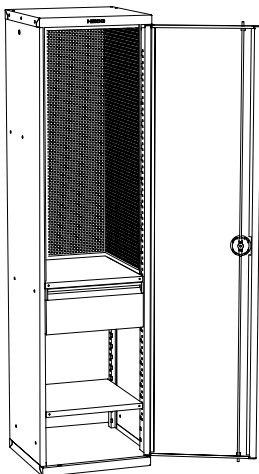

		L x A x H
157 10	65.2 Kg	500 x 490 x 1980

componentes / composants / composants

2x 157 BG * estanteria / étagère / shelf

1x 157 T50 C200 cajón / tiroir / drawer

2x 159 PPL * panel / panneau / panel

1x 157 PPF * panel / panneau / panel

* graduable / réglable / adjustable
* paneles perforados/panneaux perforés/perforated panels

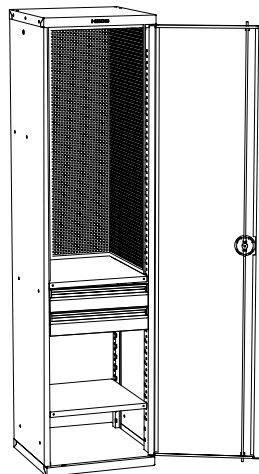

		L x A x H
157 11	67 Kg	500 x 490 x 1980

componentes / composants / composants

2x 157 BG * estanteria / étagère / shelf

2x 157 T50 C100 cajón / tiroir / drawer

2x 159 PPL * panel / panneau / panel

1x 157 PPF * panel / panneau / panel

* graduable / réglable / adjustable
* paneles perforados/panneaux perforés/perforated panels

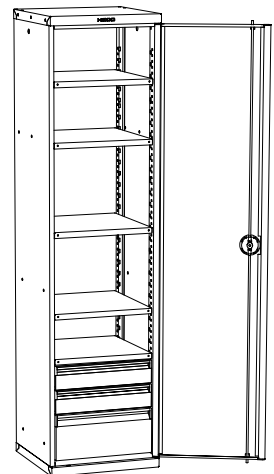

		L x A x H
157 12	62.5 Kg	500 x 490 x 1980

componentes / composants / composants

5x 157 BG * estanteria / étagère / shelf

2x 157 T50 C100 cajón / tiroir / drawer

1x 157 T50 C200 cajón / tiroir / drawer

* graduable / réglable / adjustable

SERIE 157 2P STANDARD

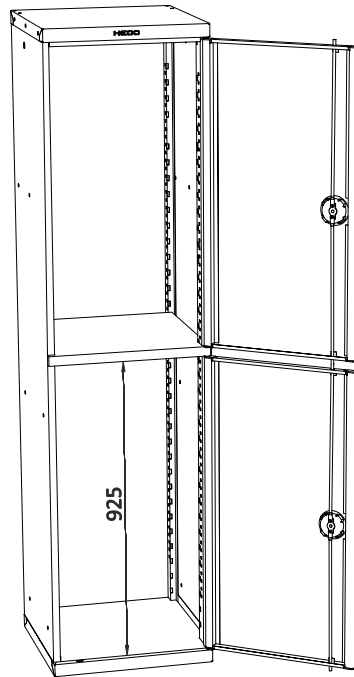

	L x A x H	
157 2 P	45 Kg	500 x 490 x 1980

 2 puertas, dos cierres.
2 portes, 2 fermetures.
2 doors, 2 closings.

 Estanterías graduables cada 25mm.
Étagères réglables chaque 25mm.
Adjustable shelves every 25mm.

 Permite adquirir componentes 157.
Permet d'acquérir des composants 157.
It allows to acquire components 157.

SERIE 157 COMPONENTES COMPOSANTS / COMPONENTS

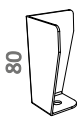

SERIE 156 P
2 unidades
unités
units
2mm

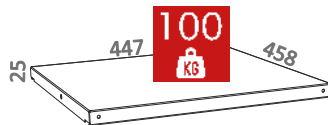

100
KG

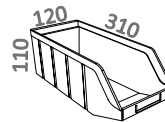

SERIE 157 CP
(4,92 l)
0,5 kg

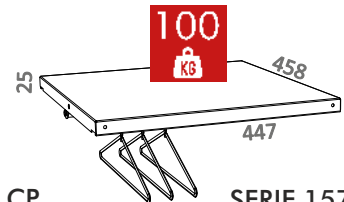

100
KG

SERIE 157 BP
2,5 kg
0,8mm

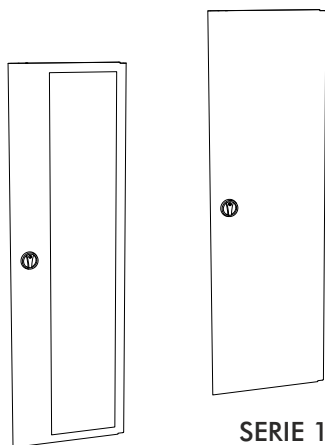

SERIE 157 P
0,6mm



SERIE 157 SC
4 kg
1mm

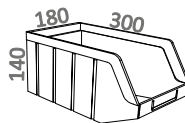

SERIE 157 CG
(7,56 l)
0,75 kg

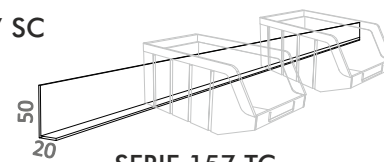

SERIE 157 TC
1,5mm

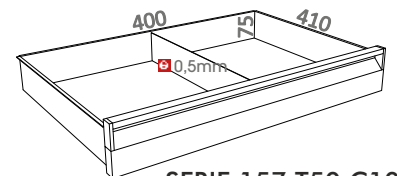

SERIE 157 T50 C100
3,5 kg
0,8mm

SERIE 157 PV
0,6mm

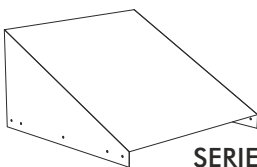

SERIE 157 TI
1mm

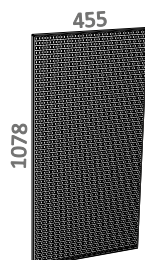

SERIE 157 PPF
12 kg
1,5mm



SERIE 159 PPL
5 kg
1,5mm

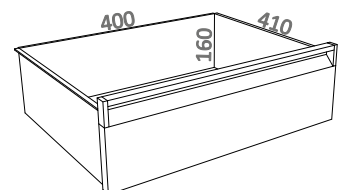

SERIE 157 T50 C200
5,5 kg
0,8mm



ACCESORIOS ver PAG. 285.
ACCESSOIRES, voir PAGE. 285.
ACCESSORIES, see PAGE. 285.

SERIE 157 C STANDARD

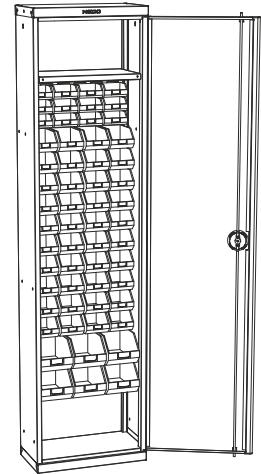
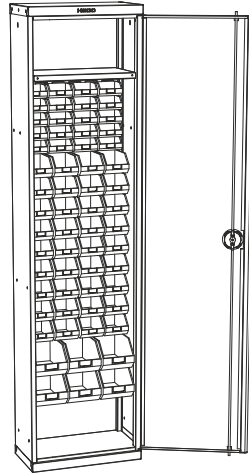
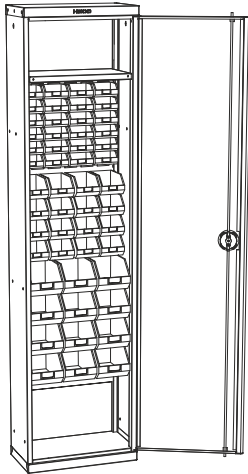

		L x A x H
157 C 1	45.58 Kg	500 x 260 x 1980

componentes / composants / composants	
24x V-BULL 1	cubeta / bac à bec / tray
16x V-BULL 2	cubeta / bac à bec / tray
12x V-BULL 3	cubeta / bac à bec / tray

 Incluye estanteria remachada
Comprend une étagère rivetée
Includes riveted shelf

		L x A x H
157 C 2	46.24 Kg	500 x 260 x 1980

componentes / composants / composants	
20x V-BULL 1	cubeta / bac à bec / tray
36x V-BULL 2	cubeta / bac à bec / tray
6x V-BULL 3	cubeta / bac à bec / tray

 Incluye estanteria remachada
Comprend une étagère rivetée
Includes riveted shelf

		L x A x H
157 C 3	46.31 Kg	500 x 260 x 1980

componentes / composants / composants	
12x V-BULL 1	cubeta / bac à bec / tray
40x V-BULL 2	cubeta / bac à bec / tray
6x V-BULL 3	cubeta / bac à bec / tray

 Incluye estanteria remachada
Comprend une étagère rivetée
Includes riveted shelf

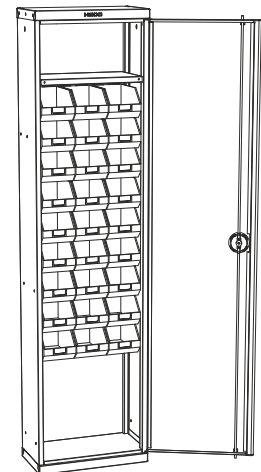
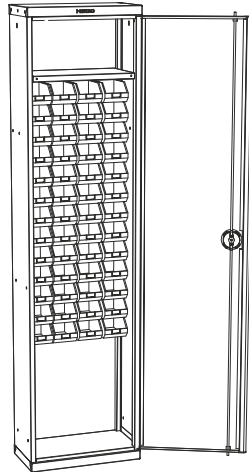
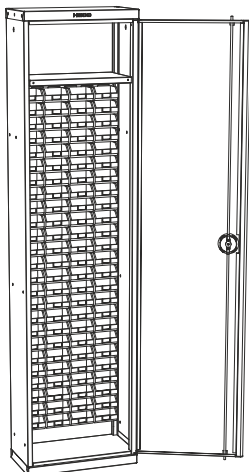

		L x A x H
157 C 4	44.60 Kg	500 x 260 x 1980

componentes / composants / composants	
100x V-BULL 1	cubeta / bac à bec / tray

 Incluye estanteria remachada
Comprend une étagère rivetée
Includes riveted shelf

		L x A x H
157 C 5	45.72 Kg	500 x 260 x 1980

componentes / composants / composants	
52x V-BULL 2	cubeta / bac à bec / tray

 Incluye estanteria remachada
Comprend une étagère rivetée
Includes riveted shelf

		L x A x H
157 C 6	46.10 Kg	500 x 260 x 1980

componentes / composants / composants	
27x V-BULL 3	cubeta / bac à bec / tray

 Incluye estanteria remachada
Comprend une étagère rivetée
Includes riveted shelf

 V-BULL ver PAG. 302.
V-BULL, voir PAGE. 302.
V-BULL, see PAGE. 302.

SERIE 158 ref. 158 1 - 158 9 / 158 C

Armario 2 puertas
Armoire 2 portes
Cabinet with 2 doors

SERIE 158

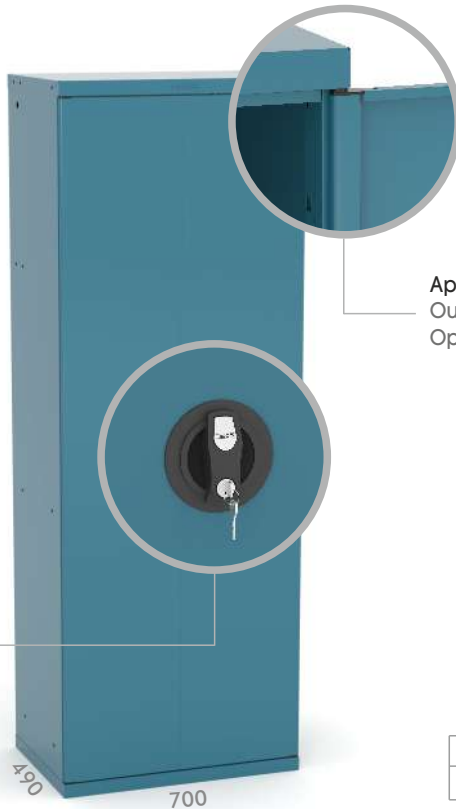

Apertura 180°.
Ouverture 180°.
Opening 180°.

Cierre con llave.
Fermeture à clé.
Key Locking.

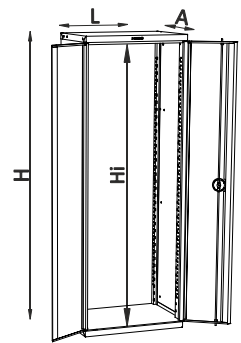

		L x A x H	Hi (mm)
158	52 Kg	700x490x1980	1865
158 C	50 Kg	700x260x1980	1865

*armazón chasis / frame

1 mm



SERIE 158 C

Armario con soportes para cubetas V-BULL 1, 2, 3
Armoire avec supports pour bacs à bec V-BULL 1, 2, 3
Cabinet with V-BULL 1, 2, 3 tray supports.

ancho 260 mm.
profondeur 260 mm.
width 260 mm.



SERIE 159 CA

Armario esquinero.
Armoire d'angle.
Corner cabinet.

Ver: PAG 78.
Voir: PAG 78.
See: PAGE 78.

CAJÓN TIROIR / DRAWER

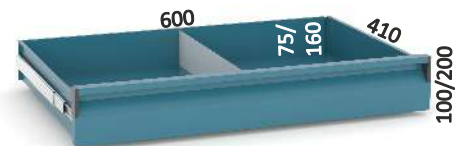

GT

Carga máxima repartida 50 Kg. Apertura total.
Charge maximum répartie 50 Kg. Ouverture totale.
Maximum distributed load 50 Kg. Complete opening.



Opcional. Ver: PAG 291.
Optionnel. Voir: PAG 291.
Optional. See: PAGE 291.



Accesorios (ver página 285).
Accessoires (voir page 285).
Accessories (see page 285).



Opción puertas de metacrilato.
Option portes méthacrylate.
Méthacrylate doors option.



Estanterías graduables cada 25mm.
Étagères réglables chaque 25mm.
Adjustable shelves every 25mm.

SERIE 158 STANDARD

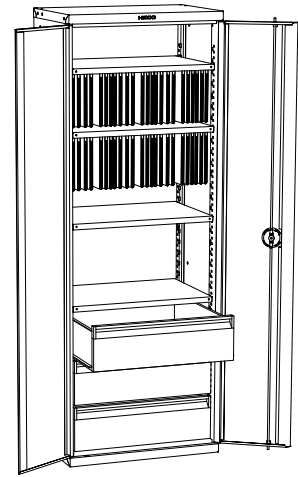
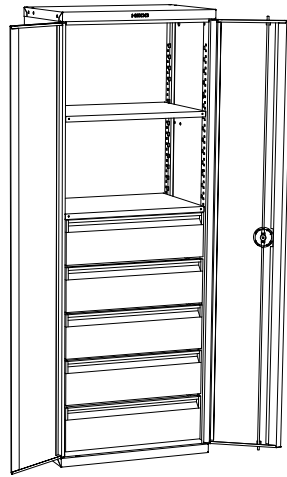
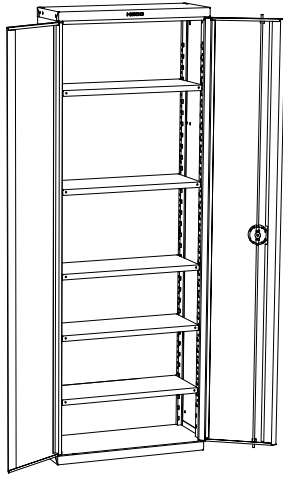

		L x A x H
158 1	64.5 Kg	700 x 490 x 1980
componentes / composants / components		
5x 158 BG	* estanteria / étagère / shelf	
* graduable / réglable / adjustable		

		L x A x H
158 2	87 Kg	700 x 490 x 1980
componentes / composants / components		
5x 158 T50 C200	cajón / tiroir / drawer	
2x 158 BG	* estanteria / étagère / shelf	
* graduable / réglable / adjustable		

		L x A x H
158 3	83.5 Kg	700 x 490 x 1980
componentes / composants / components		
2x 158 BG	* estanteria / étagère / shelf	
2x 158 BGP	* estanteria / étagère / shelf	
3x 158 T50 C200	cajón / tiroir / drawer	
* graduable / réglable / adjustable		
* para carpetas / pour des dossiers / for folders		

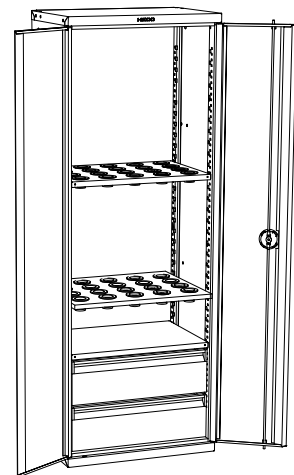
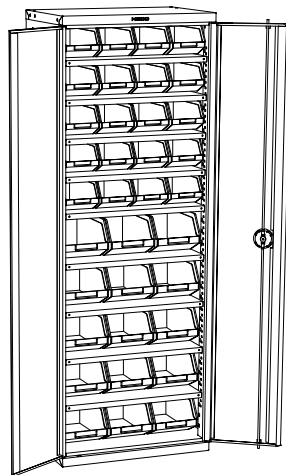
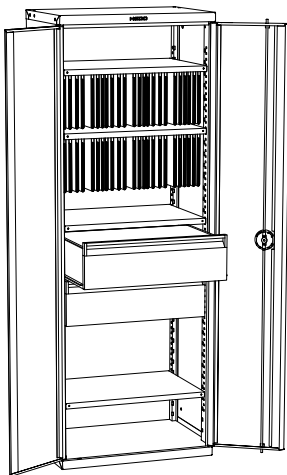

		L x A x H
158 4	75 Kg	700 x 490 x 1980
componentes / composants / components		
2x 158 BG	* estanteria / étagère / shelf	
2x 158 BGP	* estanteria / étagère / shelf	
2x 158 T50 C200	cajón / tiroir / drawer	
* graduable / réglable / adjustable		
* para carpetas / pour des dossiers / for folders		

		L x A x H
158 5	105 Kg	700 x 490 x 1980
componentes / composants / components		
20x 157 CP	* cubeta / bac à bec / tray	
9x 158 BG	* estanteria / étagère / shelf	
10x 158 TC	fin cubeta / cale bac à bec / block tray	
15x 157 CG	* cubeta / bac à bec / tray	
* graduable / réglable / adjustable		
* para carpetas / pour des dossiers / for folders		

		L x A x H
		20u. PC ISO 40
		L x A x H
158 6 1	81.5 Kg	700 x 490 x 1980
componentes / composants / components		
1x 158 BG	* estanteria / étagère / shelf	
2x 158 PC 40	* estanteria / étagère / shelf	
2x 158 T50 C200	cajón / tiroir / drawer	
* graduable / réglable / adjustable		
* porta conos / porte cônes / tool support		

SERIE 158 STANDARD

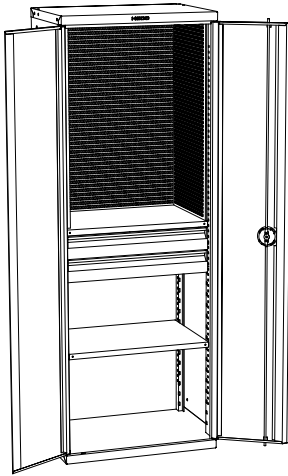

		L x A x H
158 7	83.2 Kg	700 x 490 x 1980
componentes / composants / composants		
2x 158 BG	* estanteria / étagère / shelf	
2x 157 T50 C100	cajón / tiroir / drawer	
2x 159 PPL	* panel / panneau / panel	
1x 158 PPF	* panel / panneau / panel	

* graduable / réglable / adjustable

* paneles perforados/panneaux perforés/perforated panels

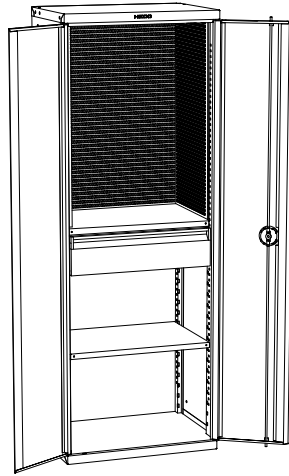

		L x A x H
158 8	81.2 Kg	700 x 490 x 1980
componentes / composants / composants		
2x 158 BG	* estanteria / étagère / shelf	
1x 158 T50 C200	cajón / tiroir / drawer	
2x 159 PPL	* panel / panneau / panel	
1x 158 PPF	* panel / panneau / panel	

* graduable / réglable / adjustable

* paneles perforados/panneaux perforés/perforated panels

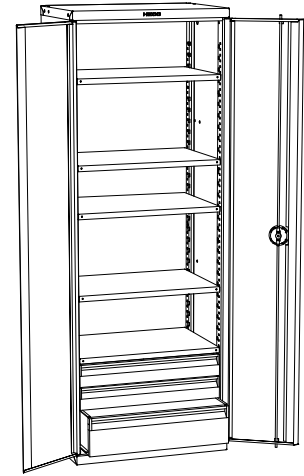

		L x A x H
158 9	78.5 Kg	700 x 490 x 1980
componentes / composants / composants		
5x 158 BG	* estanteria / étagère / shelf	
2x 158 T50 C100	* estanteria / étagère / shelf	
1x 158 T50 C200	* estanteria / étagère / shelf	

* graduable / réglable / adjustable

SERIE 158 C STANDARD



V-BULL ver PAG. 302.
V-BULL, voir PAGE. 302.
V-BULL, see PAGE. 302.

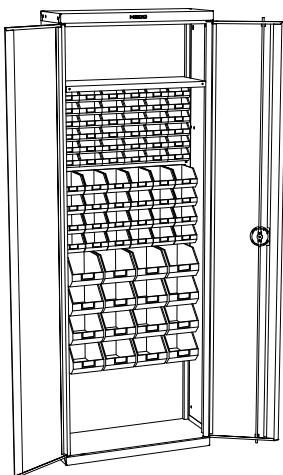

		L x A x H
158 C 1	57.91 Kg	700 x 260 x 1980
componentes / composants / composants		
36x V-BULL 1	cubeta / bac à bec / tray	
24x V-BULL 2	cubeta / bac à bec / tray	
16x V-BULL 3	cubeta / bac à bec / tray	

Incluye estanteria remachada
Comprend une étagère rivetée
Includes riveted shelf

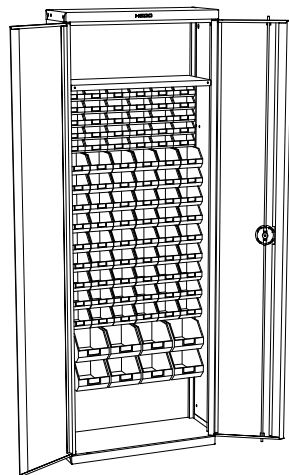

		L x A x H
158 C 2	59.13 Kg	700 x 260 x 1980
componentes / composants / composants		
30x V-BULL 1	cubeta / bac à bec / tray	
54x V-BULL 2	cubeta / bac à bec / tray	
8x V-BULL 3	cubeta / bac à bec / tray	

Incluye estanteria remachada
Comprend une étagère rivetée
Includes riveted shelf

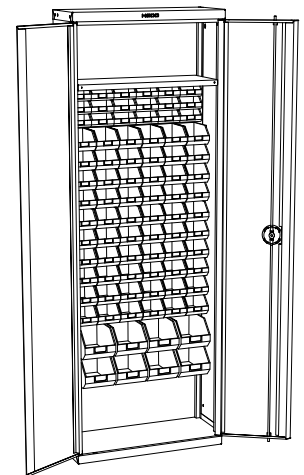

		L x A x H
158 C 3	59.24 Kg	700 x 260 x 1980
componentes / composants / composants		
18x V-BULL 1	cubeta / bac à bec / tray	
60x V-BULL 2	cubeta / bac à bec / tray	
8x V-BULL 3	cubeta / bac à bec / tray	

Incluye estanteria remachada
Comprend une étagère rivetée
Includes riveted shelf

SERIE 158 C STANDARD



V-BULL ver PAG. 302.
V-BULL, voir PAGE. 302.
V-BULL, see PAGE. 302.

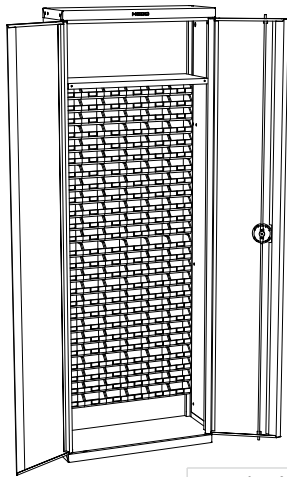

LxAxH		
158 C 4	56.90 Kg	700 x 260 x 1980

componentes / composants / composants		
150x V-BULL 1	cubeta / bac à bec / tray	

Incluye estantería remachada
Comprend une étagère rivetée
Includes riveted shelf

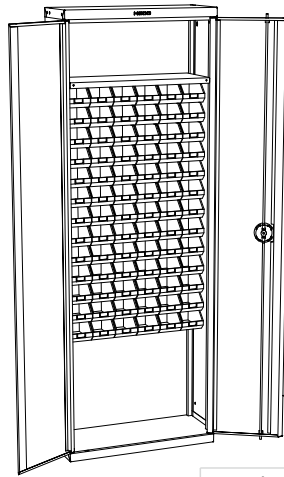

LxAxH		
158 C 5	58.58 Kg	700 x 260 x 1980

componentes / composants / composants		
78x V-BULL 2	cubeta / bac à bec / tray	

Incluye estantería remachada
Comprend une étagère rivetée
Includes riveted shelf

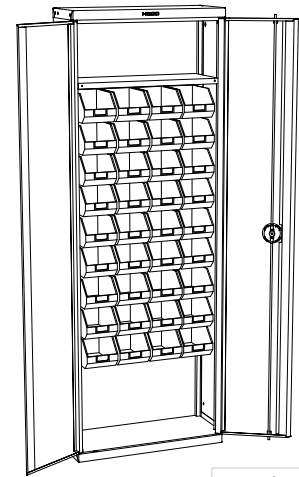

LxAxH		
158 C 6	58.14 Kg	700 x 260 x 1980

componentes / composants / composants		
36x V-BULL 3	cubeta / bac à bec / tray	

Incluye estantería remachada
Comprend une étagère rivetée
Includes riveted shelf

SERIE 158 COMPONENTES / COMPOSANTS / COMPONENTS

SERIE 156 P
2 unidades / unités / units
2mm

SERIE 157 CP
(4,92 l)
0,5 kg

SERIE 157 CG
(7,56 l)
0,75 kg

SERIE 158 TC
0,53 kg
1,5mm

SERIE 158 BG
2,5 kg
1mm

SERIE 158 BGP
3 kg
1mm

SERIE 158 TI
1mm

SERIE 158 T50 C100
4 kg
0,8mm

SERIE 158 T50 C200
6 kg
0,8mm

SERIE 158 P
0,6mm

SERIE 158 PV
0,6mm

SERIE 158 PPF
8,2 kg
1,5mm

SERIE 159 PPL
5 kg
1,5mm

SERIE 158 PC 40
16x ISO40
7,5 kg
2mm

SERIE 158 PC 50
16x ISO50
7 kg
2mm



ACCESORIOS ver PAG. 285.
ACCESSOIRES, voir PAGE. 285.
ACCESSORIES, see PAGE. 285.

SERIE 159 ref. 159 / 159 CA / 159 C / 159 B / 159 P / 159 F6 / 159 P B

Armario 2 puertas
Armoire 2 portes
Cabinet with 2 doors

Apertura 180°. /
Ouverture 180° /
Opening 180°.

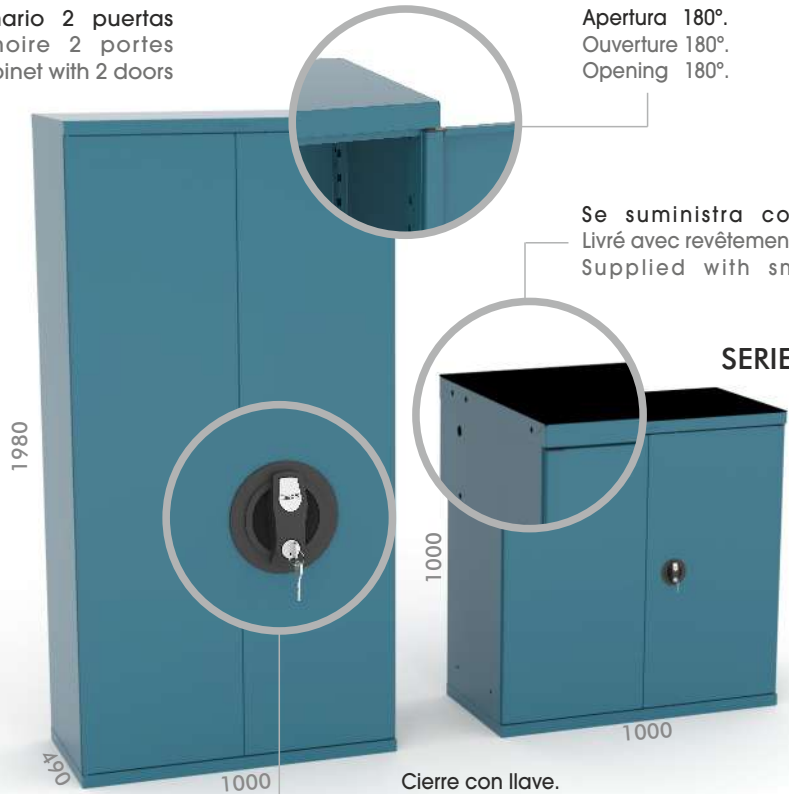

Se suministra con goma lisa.
Livré avec revêtement caoutchouc lisse.
Supplied with smooth rubber.

SERIE 159 B

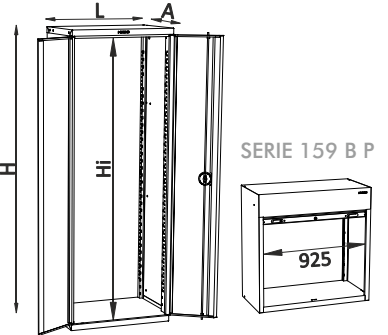

		L x A x H	Hi (mm)
159	65 Kg	1000x490x1980	1865
159 B	35.5 Kg	1000x490x1000	865
159 C	70 Kg	1000x260x1980	1865
159 F6	35.5 Kg	1000x600x1980	1865
159 P	76 Kg	1005x500x1980	1700
159 P B	47 Kg	1005x500x1000	720
159 CA	102 Kg	496x(490)x1980	1865
159 CA F6	120 Kg	496x(600)x1000	1865

*armazón chasis / frame

1 mm

SERIE 159

Cierre con llave.
Fermeture à clé.
Key Locking.



Accesorios (ver página 285).
Accessoires (voir page 285).
Accessories (see page 285).



Opcional. Ver: PAG 291.
Optionnel. Voir: PAG 291.
Optional. See: PAGE 291.



Opción puertas de metacrilato.
Options portes methacrylate.
Methacrylate doors option.



Estanterías graduables cada 25mm.
Étagères réglables chaque 25mm.
Adjustable shelves every 25mm.

CAJÓN TIROIR / DRAWER

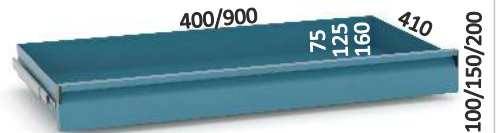

Carga máxima repartida 50 Kg. Apertura total.
Charge maximum répartie 50 Kg. Ouverture totale.
Maximum distributed load 50 Kg. Complete opening.



SERIE 159 C

ancho 260 mm.
profondeur 260 mm.
width 260 mm.



SERIE 159 F6

ancho 600 mm.
profondeur 600 mm.
width 600 mm.



SERIE 159 P - 159 P B

con persiana.
avec rideau.
with shutter closure.



SERIE 159 STANDARD

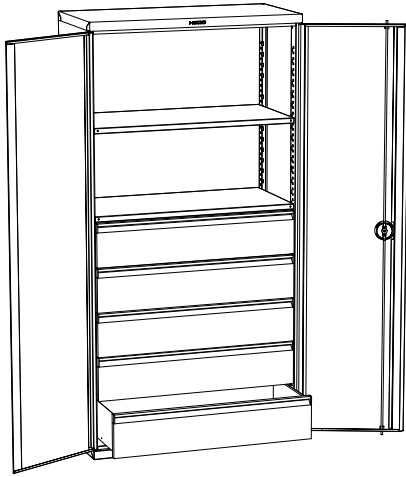

159 1	113.5 Kg	L x A x H 1000 x 490 x 1980
-------	----------	--------------------------------

componentes / composants / components		
5x 159 T50 C200	cajón / tiroir / drawer	
2x 159 BG	* estanteria / étagère / shelf	
* graduable / réglable / adjustable		

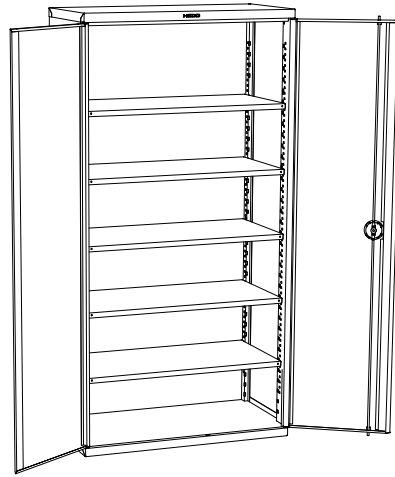

159 2	87.5 Kg	L x A x H 1000 x 490 x 1980
-------	---------	--------------------------------

componentes / composants / components		
5x 159 BG	* bandeja / plateau / tray	
* graduable / réglable / adjustable		

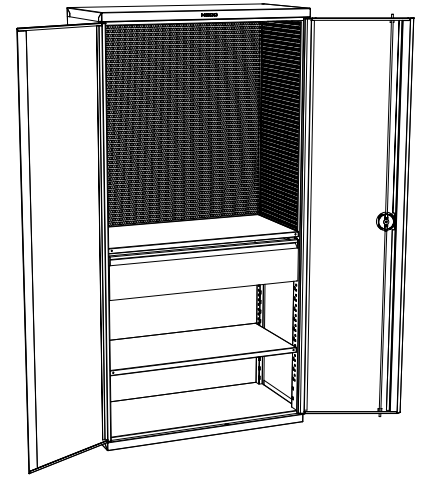

159 3	98.5 Kg	L x A x H 1000 x 490 x 1980
-------	---------	--------------------------------

componentes / composants / components		
2x 159 BG	* estanteria / étagère / shelf	
1x 159 T50 C200	cajón / tiroir / drawer	
2x 159 PPL	* panel / panneau / panel	
1x 159 PPF	* panel / panneau / panel	
* graduable / réglable / adjustable		
* paneles perforados/panneaux perforés/perforated panels		

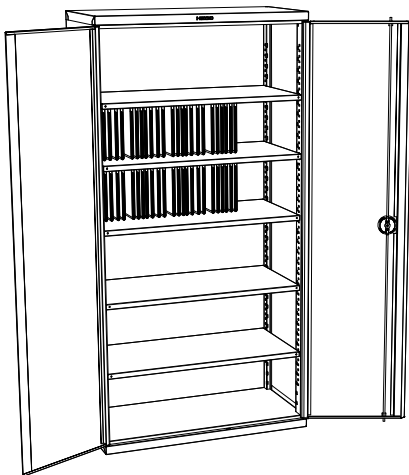

159 4	83 Kg	L x A x H 1000 x 490 x 1980
-------	-------	--------------------------------

componentes / composants / components		
3x 159 BG	* bandeja / plateau / tray	
2x 159 BGP	* bandeja / plateau / tray	
* graduable / réglable / adjustable		
* para carpetas / pour des dossiers / for folders		

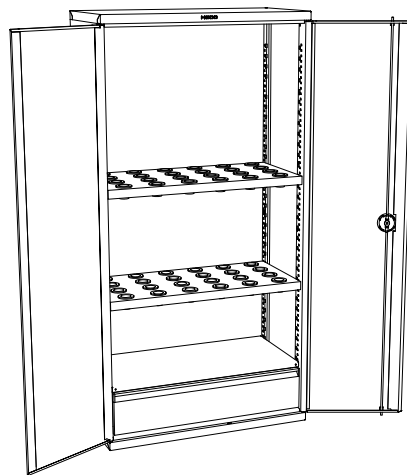

159 5 1	94.5 Kg	L x A x H 1000 x 490 x 1980
---------	---------	--------------------------------

componentes / composants / components		
1x 159 T50 C200	cajón / tiroir / drawer	
1x 159 BG	* estanteria / étagère / shelf	
2x 159 PC40	* estanteria / étagère / shelf	
* graduable / réglable / adjustable		
ISO40 * porta conos / porte cônes / tool support		

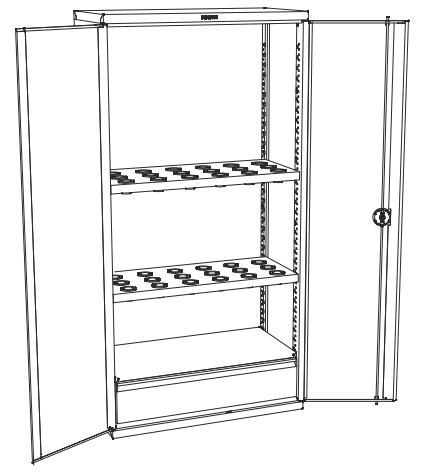

159 5 1 5	94.5 Kg	L x A x H 1000 x 490 x 1980
-----------	---------	--------------------------------

componentes / composants / components		
1x 159 T50 C200	cajón / tiroir / drawer	
1x 159 BG	* estanteria / étagère / shelf	
2x 159 PC50	* estanteria / étagère / shelf	
* graduable / réglable / adjustable		
ISO50 * porta conos / porte cônes / tool support		

SERIE 159 STANDARD

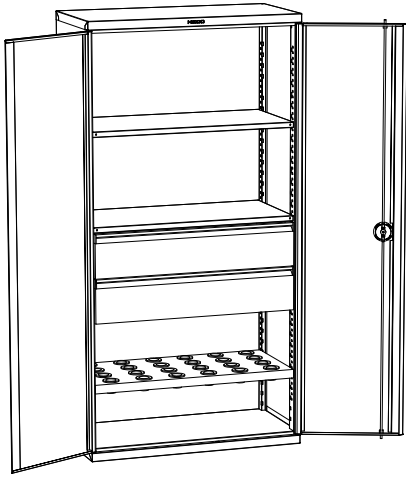

2x 24u. PC ISO 40

L x A x H		
159 6 1	96.5 Kg	1000 x 490 x 1980

componentes / composants / composants		
2x 159 T50 C200	cajón / tiroir / drawer	
2x 159 BG	* estanteria / étagère / shelf	
1x 159 PC40	estanteria / étagère / shelf	

* graduable / réglable / adjustable
ISO40 * porta conos / porte cônes / tool support

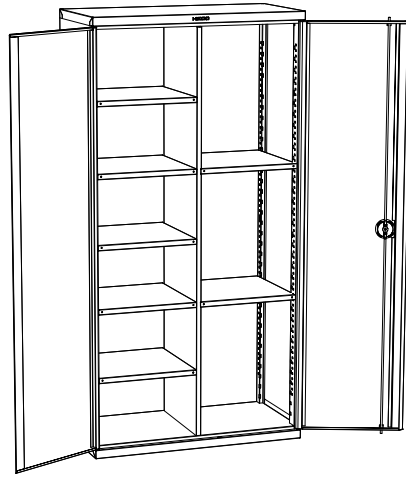

L x A x H		
159 7	92.5 Kg	1000 x 490 x 1980

componentes / composants / composants		
7x 157 BG	* estanteria / étagère / shelf	
159 SC	separador / séparateur / separating	

* graduable / réglable / adjustable

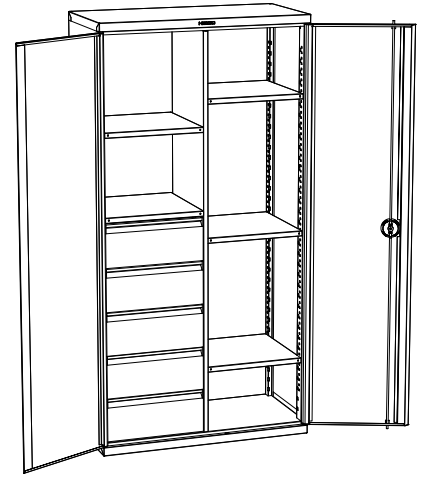

L x A x H		
159 8	120.5 Kg	1000 x 490 x 1980

componentes / composants / composants		
5x 157 T50 C200	cajón / tiroir / drawer	
5x 157 BG	* estanteria / étagère / shelf	
157 SC	separador / séparateur / separating	

* graduable / réglable / adjustable

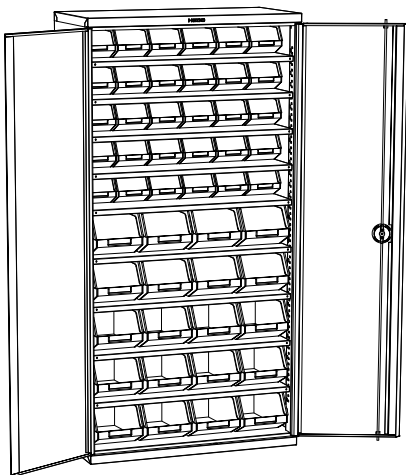

L x A x H		
159 9	122 Kg	1000 x 490 x 1980

componentes / composants / composants		
9x 159 BG	* estanteria / étagère / shelf	
30x 157 CP	cubeta / bac à bec / tray	
20x 157 CG	cubeta / bac à bec / tray	
10x 159 TC	fin cubeta / cale bac à bec / block tray	

* graduable / réglable / adjustable

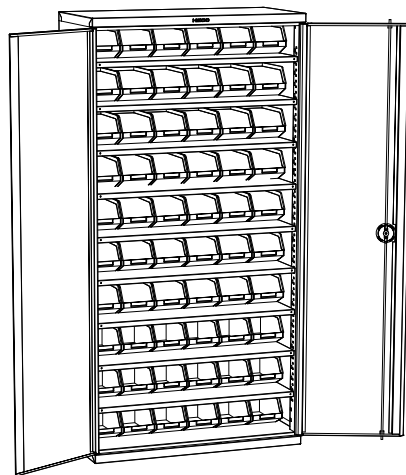

L x A x H		
159 9 CP	129.60 Kg	1000 x 490 x 1980

componentes / composants / composants		
9x 159 BG	* estanteria / étagère / shelf	
60x 157 CP	cubeta / bac à bec / tray	
10x 159 TC	fin cubeta / cale bac à bec / block tray	

* graduable / réglable / adjustable

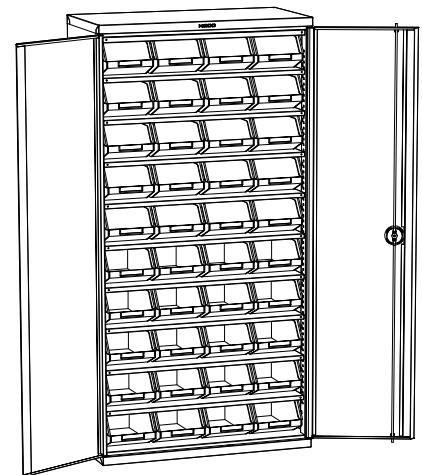

L x A x H		
159 9 CG	129.6 Kg	1000 x 490 x 1980



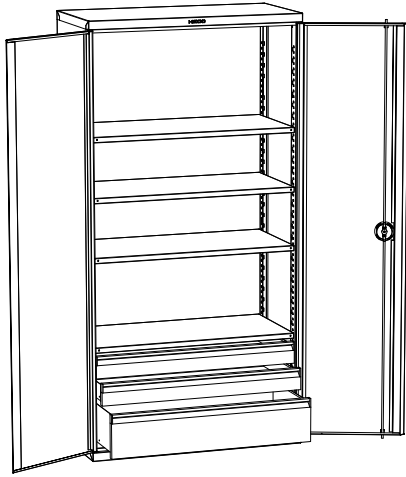

componentes / composants / composants		
9x 159 BG	* estanteria / étagère / shelf	
40x 157 CG	cubeta / bac à bec / tray	
10x 159 TC	fin cubeta / cale bac à bec / block tray	

* graduable / réglable / adjustable

SERIE 159 STANDARD





		L x A x H
159 10	95.5 Kg	1000 x 490 x 1980

componentes / composants / components	
4x 159 BG	* estanteria / étagère / shelf
2x 159 T50 C100	cajón / tiroir / drawer  
1x 159 T50 C200	cajón / tiroir / drawer  

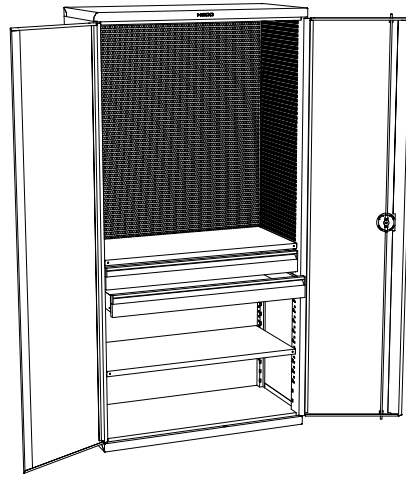
* graduable / réglable / adjustable





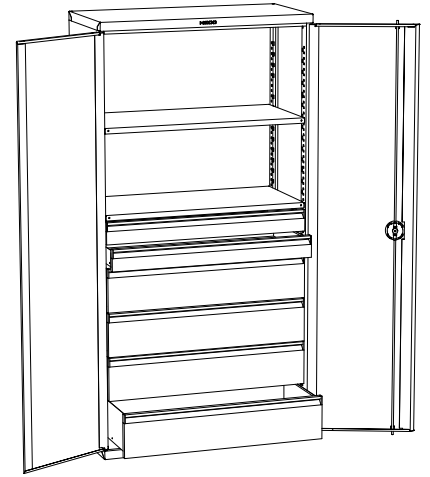

		L x A x H
159 11	106 Kg	1000 x 490 x 1980

componentes / composants / components	
2x 159 BG	* estanteria / étagère / shelf
2x 159 T50 C100	cajón / tiroir / drawer  
2x 159 PPL	panel / panneau / panel
1x 159 PPF	panel / panneau / panel

* graduable / réglable / adjustable
* paneles perforados/panneaux perforés/perforated panels





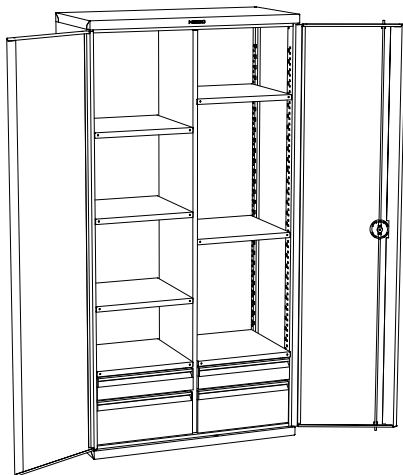

		L x A x H
159 12	118 Kg	1000 x 490 x 1980

componentes / composants / components	
2x 159 BG	* estanteria / étagère / shelf
2x 159 T50 C100	cajón / tiroir / drawer  
4x 159 T50 C200	cajón / tiroir / drawer  

* graduable / réglable / adjustable





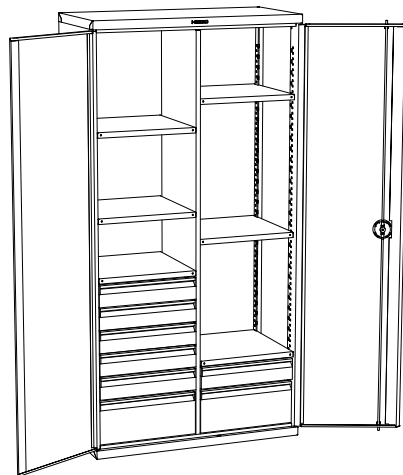

		L x A x H
159 13	110.5 Kg	1000 x 490 x 1980

componentes / composants / components	
7x 157 BG	* estanteria / étagère / shelf
2x 157 T50 C100	cajón / tiroir / drawer  
2x 157 T50 C200	cajón / tiroir / drawer  
159 SC	separador / séparateur / separator

* graduable / réglable / adjustable





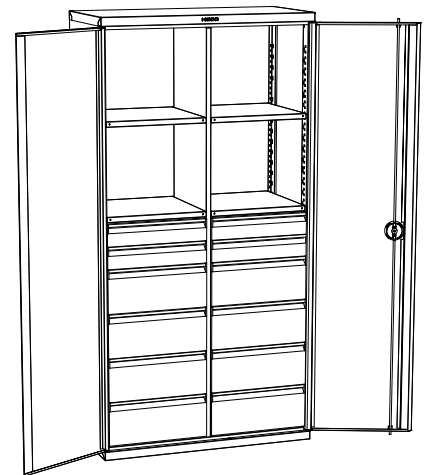

		L x A x H
159 14	122.5 Kg	1000 x 490 x 1980

componentes / composants / components	
6x 157 BG	* estanteria / étagère / shelf
6x 157 T50 C100	cajón / tiroir / drawer  
2x 157 T50 C200	cajón / tiroir / drawer  
159 SC	separador / séparateur / separator

* graduable / réglable / adjustable



		L x A x H
159 15	144.5 Kg	1000 x 490 x 1980

componentes / composants / components	
4x 157 BG	* estanteria / étagère / shelf
4x 157 T50 C100	cajón / tiroir / drawer  
8x 157 T50 C200	cajón / tiroir / drawer  
159 SC	separador / séparateur / separator

* graduable / réglable / adjustable

SERIE 159 STANDARD

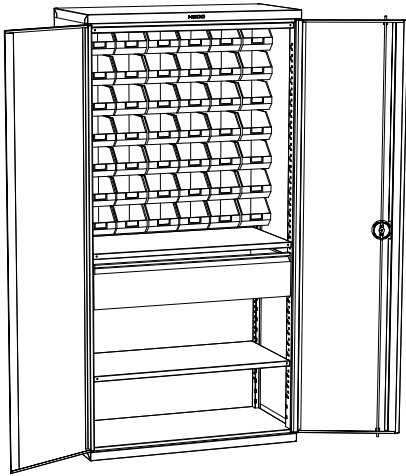

		L x A x H
159 16	110 Kg	1000 x 490 x 1980
componentes / composants / composants		
42x V-BULL 3	cubetas / bacs à bec / tray	
1x 159 T50 C200	cajón / tiroir / drawer	
2x 159 BG	* estanteria / étagère / shelf	

* graduable / réglable / adjustable

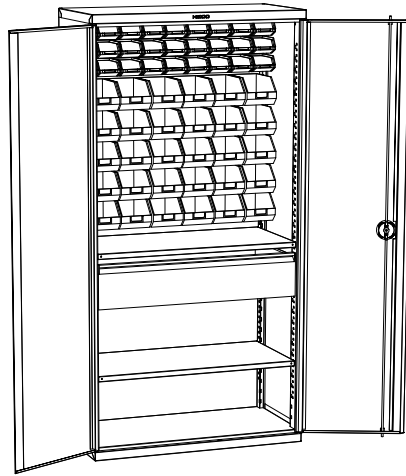

		L x A x H
159 17	110 Kg	1000 x 490 x 1980
componentes / composants / composants		
27x V-BULL 2	cubetas / bacs à bec / tray	
30x V-BULL 3	cubetas / bacs à bec / tray	
1x 159 T50 C200	cajón / tiroir / drawer	
2x 159 BG	* estanteria / étagère / shelf	

* graduable / réglable / adjustable

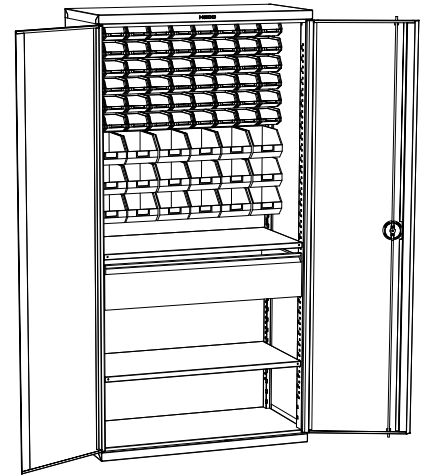

		L x A x H
159 18	110 Kg	1000 x 490 x 1980
componentes / composants / composants		
54x V-BULL 2	cubetas / bacs à bec / tray	
18x V-BULL 3	cubetas / bacs à bec / tray	
1x 159 T50 C200	cajón / tiroir / drawer	
2x 159 BG	* estanteria / étagère / shelf	

* graduable / réglable / adjustable

SERIE 159 CA STANDARD

Armario esquinero 1 puerta
Armoire cantonnière 1 porte
Corner cabinet with 1 door

new

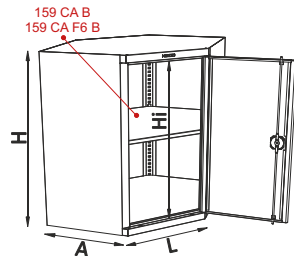

A 490 mm

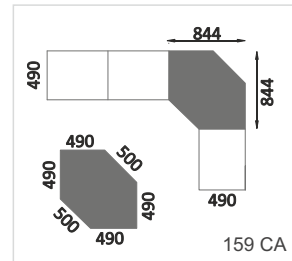

159 CA

A 600 mm

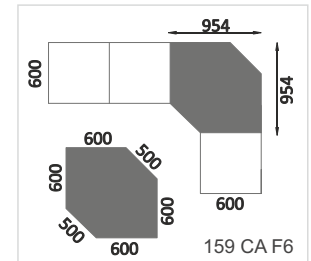

159 CA F6

		L x A x H	Hi	
159 CA	70 Kg	100 Kg	500 x (490) x 1980	1897
159 CA F6	83 Kg	113 Kg	503 x (600) x 1980	1897
159 B CA	44 Kg	71 Kg	500 x (490) x 1000	917
159 B CA F6	52 Kg	79 Kg	503 x (600) x 1000	917

accesorios / accessoires / accessories

159 CA B	7 Kg	estanteria / étagère / shelf
159 CA F6 B	9,5 Kg	estanteria / étagère / shelf

1 mm

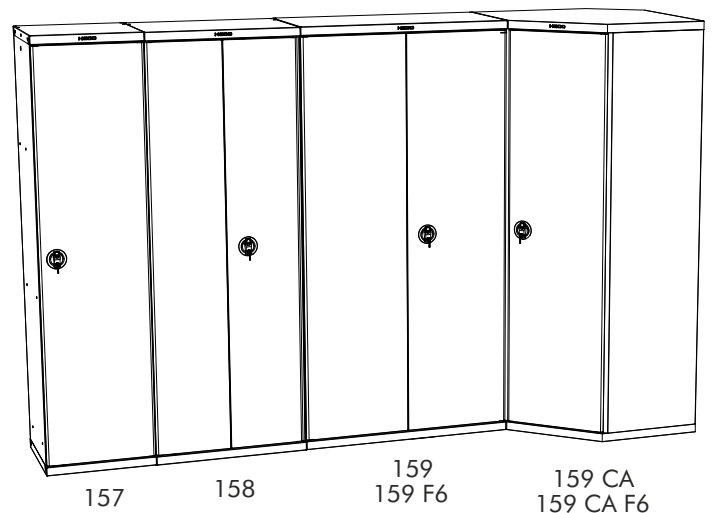

Opciones para oficinas personalizadas WORKOFFICE (pag.227).
Options pour poste de travail sur mesure WORKOFFICE (pag.227).
Personalized workstation options WORKOFFICE (pag.227).

SERIE 159 C STANDARD

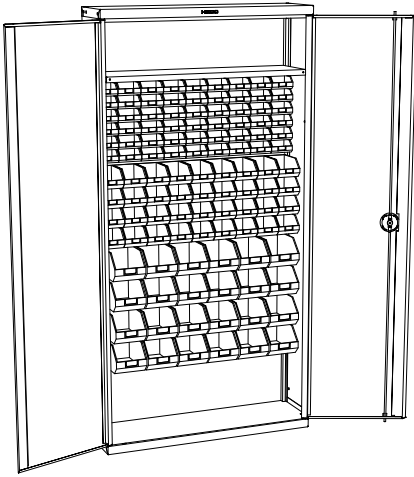

		LxAxH
159 C 1	81.37 Kg	1000 x 260 x 1980
componentes / composants / composants		
54x V-BULL 1	cubeta / bacs à bec / tray	
36x V-BULL 2	cubeta / bacs à bec / tray	
24x V-BULL 3	cubeta / bacs à bec / tray	

 Incluye estantería remachada
Comprend une étagère rivetée
Includes riveted shelf

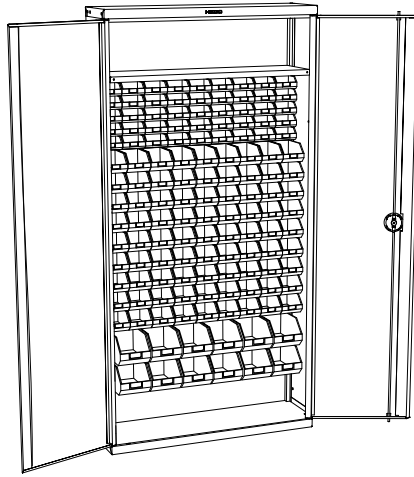

		LxAxH
159 C 2	83.69 Kg	1000 x 260 x 1980
componentes / composants / composants		
45x V-BULL 1	cubeta / bacs à bec / tray	
81x V-BULL 2	cubeta / bacs à bec / tray	
12x V-BULL 3	cubeta / bacs à bec / tray	

 Incluye estantería remachada
Comprend une étagère rivetée
Includes riveted shelf

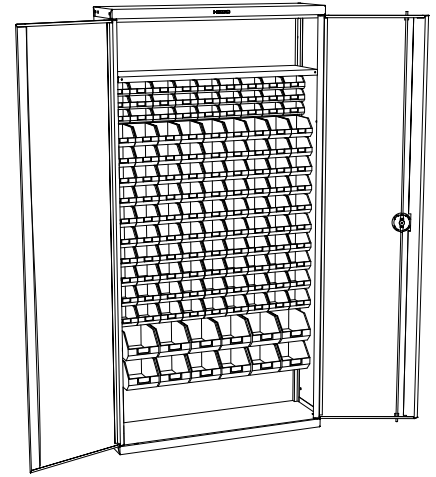

		LxAxH
159 C 3	83.85 Kg	1000 x 260 x 1980
componentes / composants / composants		
27x V-BULL 1	cubeta / bacs à bec / tray	
90x V-BULL 2	cubeta / bacs à bec / tray	
12x V-BULL 3	cubeta / bacs à bec / tray	

 Incluye estantería remachada
Comprend une étagère rivetée
Includes riveted shelf

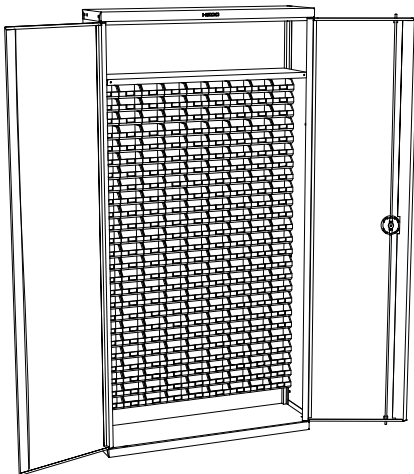

		LxAxH
159 C 4	80.35 Kg	1000 x 260 x 1980
componentes / composants / composants		
225x V-BULL 1	cubeta / bacs à bec / tray	

 Incluye estantería remachada
Comprend une étagère rivetée
Includes riveted shelf

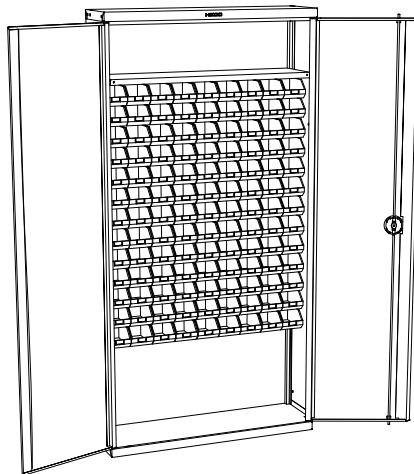

		LxAxH
159 C 5	82.87 Kg	1000 x 260 x 1980
componentes / composants / composants		
117x V-BULL 2	cubeta / bacs à bec / tray	

 Incluye estantería remachada
Comprend une étagère rivetée
Includes riveted shelf

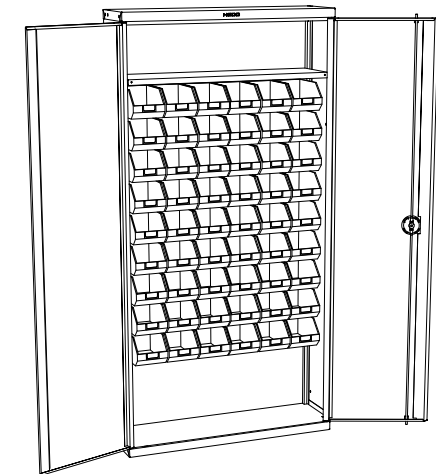

		LxAxH
159 C 6	82.20 Kg	1000 x 260 x 1980
componentes / composants / composants		
54x V-BULL 3	cubeta / bacs à bec / tray	

 Incluye estantería remachada
Comprend une étagère rivetée
Includes riveted shelf

 V-BULL ver PAG. 302.
V-BULL, voir PAGE. 302.
V-BULL, see PAGE. 302.

SERIE 159 B STANDARD



		L x A x H
159 B 1	41.5 Kg	1000 x 490 x 1000
componentes / composants / composants		
2x 159 BG	* estanteria / étagère / shelf	

* graduable / réglable / adjustable

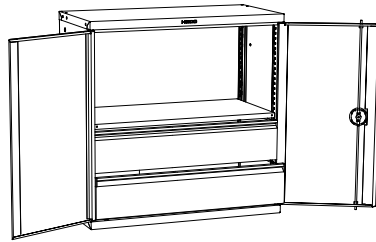

		L x A x H
159 B 2	55.5 Kg	1000 x 490 x 1000
componentes / composants / composants		
1x 159 BG	* estanteria / étagère / shelf	
2x 159 T50 C200	cajón / tiroir / drawer	

* graduable / réglable / adjustable

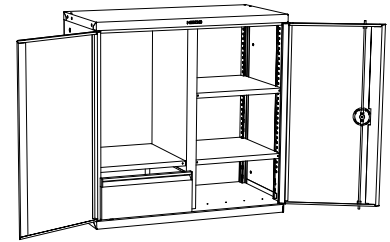

		L x A x H
159 B 3	51.5 Kg	1000 x 490 x 1000
componentes / composants / composants		
3x 157 BG	* estanteria / étagère / shelf	
1x 159 B SC	separador / séparateur / separator	
1x 157 T50 C200	cajón / tiroir / drawer	

* graduable / réglable / adjustable

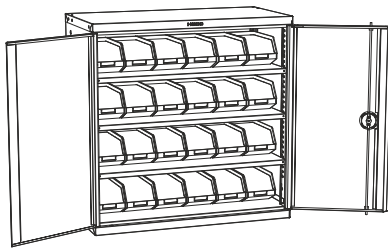

		L x A x H
159 B 4	53.5 Kg	1000 x 490 x 1000
componentes / composants / composants		
3x 159 BG	* estanteria / étagère / shelf	
24x 157 CP	cubeta / bac à bec / tray	

* graduable / réglable / adjustable

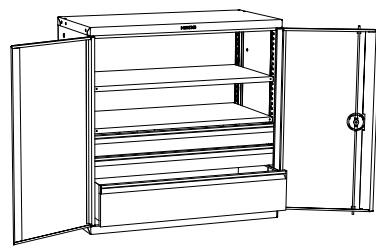

		L x A x H
159 B 5	63 Kg	1000 x 490 x 1000
componentes / composants / composants		
2x 159 BG	* estanteria / étagère / shelf	
2x 159 T50 C100	cajón / tiroir / drawer	
1x 159 T50 C200	cajón / tiroir / drawer	

* graduable / réglable / adjustable

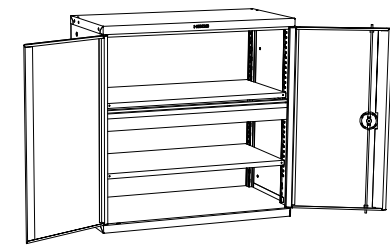

		L x A x H
159 B 6	48 Kg	1000 x 490 x 1000
componentes / composants / composants		
2x 159 BG	* estanteria / étagère / shelf	
1x 159 T50 C100	cajón / tiroir / drawer	

* graduable / réglable / adjustable

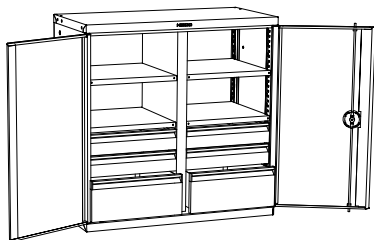

		L x A x H
159 B 7	73 Kg	1000 x 490 x 1000
componentes / composants / composants		
4x 157 BG	* estanteria / étagère / shelf	
1x 159 B SC	separador / séparateur / separator	
4x 157 T50 C100	cajón / tiroir / drawer	
2x 157 T50 C200	cajón / tiroir / drawer	

* graduable / réglable / adjustable

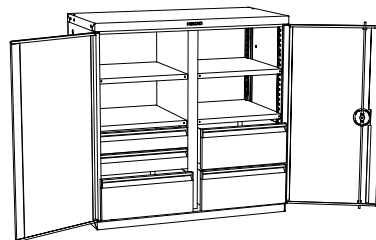

		L x A x H
159 B 8	71.5 Kg	1000 x 490 x 1000
componentes / composants / composants		
4x 157 BG	* estanteria / étagère / shelf	
1x 159 B SC	separador / séparateur / separator	
2x 157 T50 C100	cajón / tiroir / drawer	
3x 157 T50 C200	cajón / tiroir / drawer	

* graduable / réglable / adjustable

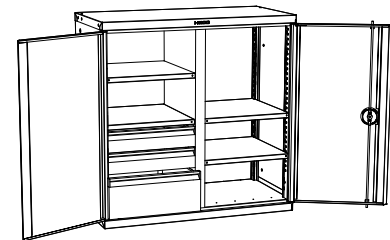

		L x A x H
159 B 9	60.5 Kg	1000 x 490 x 1000
componentes / composants / composants		
4x 157 BG	* estanteria / étagère / shelf	
1x 159 B SC	separador / séparateur / separator	
2x 157 T50 C100	cajón / tiroir / drawer	
1x 157 T50 C200	cajón / tiroir / drawer	

* graduable / réglable / adjustable

SERIE 159 COMPONENTES / COMPOSANTS / COMPONENTS

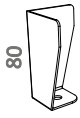

SERIE 156 P
2 unidades
unités
units
2mm

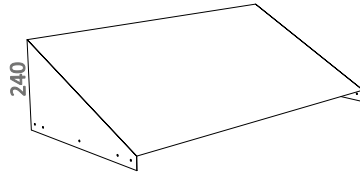

SERIE 159 TI
1mm

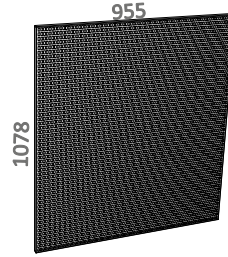

SERIE 159 PPF
12 kg
1,5mm

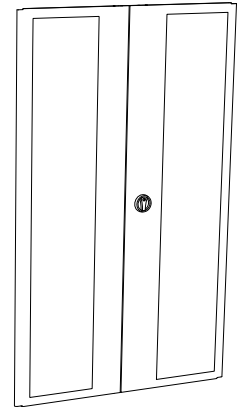

SERIE 159 PV
SERIE 159 B PV
0,6mm

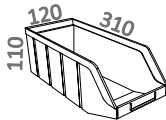

SERIE 157 CP
(4,92 l)
0,5 kg



SERIE 159 B SC
4,5 kg
1mm



SERIE 159 SC
13,5 kg
1mm



SERIE 159 PPL
5 kg
1,5mm

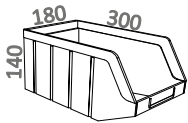

SERIE 157 CG
(7,56 l)
0,75 kg

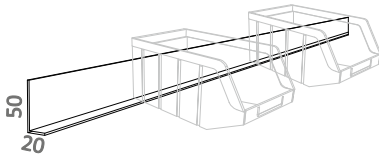

SERIE 159 TC
0,76 kg
1,5mm

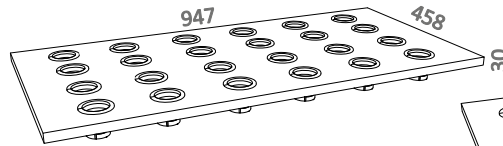

SERIE 159 PC 40
24x ISO40
9 kg
2,5mm

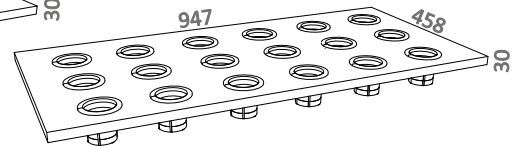

SERIE 159 PC 50
18x ISO50
8,5 kg
2,5mm

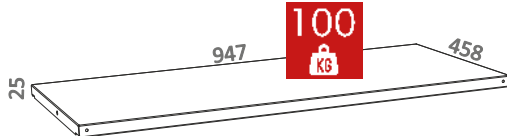

SERIE 159 BG
3 kg
1mm

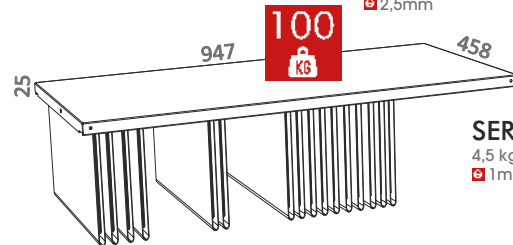

SERIE 159 BGP
4,5 kg
1mm

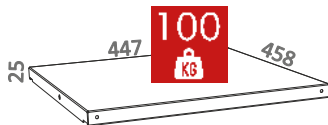

SERIE 157 BG
2 kg
0,8mm

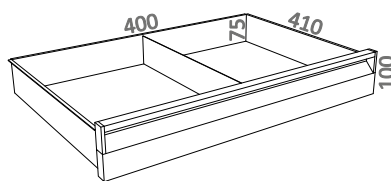

SERIE 157 T50 C100
3,5 kg
0,7mm

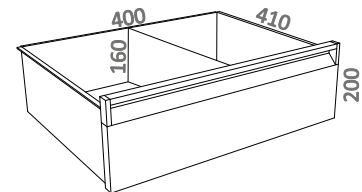

SERIE 157 T50 C200
5,5 kg
0,7mm

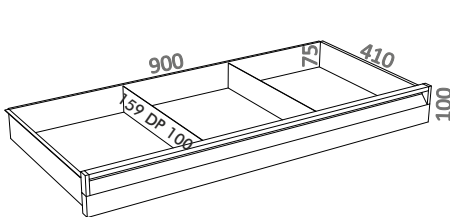

SERIE 159 T50 C100
6,5 kg
0,8mm

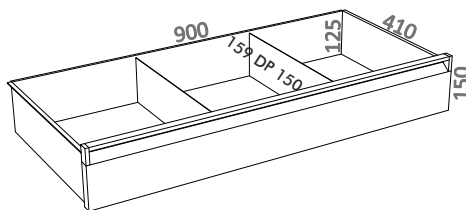

SERIE 159 T50 C150
7,5 kg
0,8mm

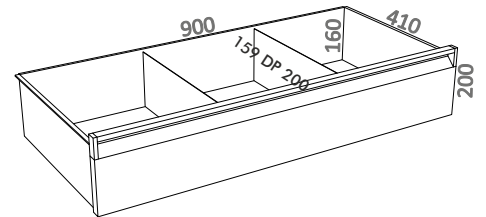

SERIE 159 T50 C200
8,5 kg
0,8mm

SERIE 159 DP 100
Separador para cajón 100mm.
Séparateur pour tiroir 100mm.
Drawer 100mm divider.

SERIE 159 DP 150
Separador para cajón 150mm.
Séparateur pour tiroir 150mm.
Drawer 150mm divider.

SERIE 159 DP 200
Separador para cajón 200mm.
Séparateur pour tiroir 200mm.
Drawer 200mm divider.



ACCESORIOS ver PAG. 285.
ACCESSOIRES, voir PAGE. 285.
ACCESSORIES, see PAGE. 285.

SERIE 159 P STANDARD

Armario con persiana.
Armoire avec rideau.
Cabinet with shutter closing.

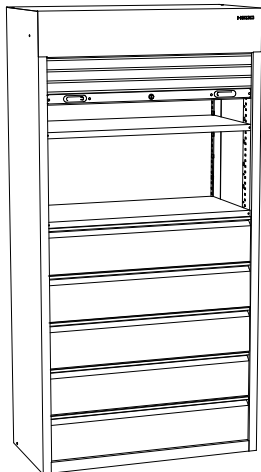

		L x A x H
159 P 1	116 Kg	1005 x 500 x 1980
componentes / composants / composants		
2x 159 P BG	* estanteria / étagère / shelf	
5x 159 P T50 C200	cajón / tiroir / drawer	

* graduable / réglable / adjustable

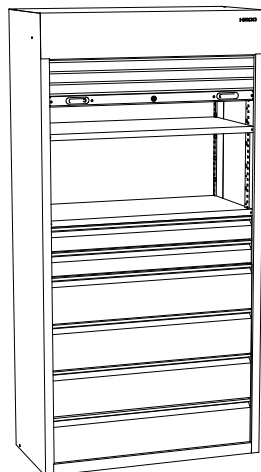

		L x A x H
159 P 2	119 Kg	1005 x 500 x 1980
componentes / composants / composants		
2x 159 P BG	* estanteria / étagère / shelf	
2x 159 P T50 C100	cajón / tiroir / drawer	
4x 159 P T50 C200	cajón / tiroir / drawer	

* graduable / réglable / adjustable

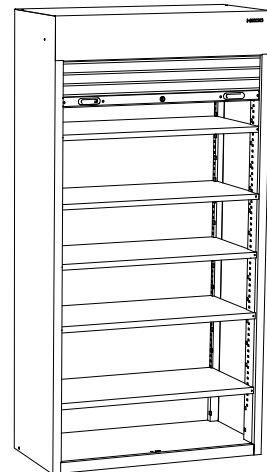

		L x A x H
159 P 3	101 Kg	1005 x 500 x 1980
componentes / composants / composants		
5x 159 P BG	* estanteria / étagère / shelf	

* graduable / réglable / adjustable

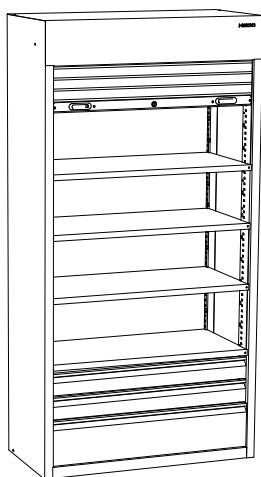

		L x A x H
159 P 4	111 Kg	1005 x 500 x 1980
componentes / composants / composants		
4x 159 P BG	* estanteria / étagère / shelf	
2x 159 P T50 C100	cajón / tiroir / drawer	
1x 159 P T50 C200	cajón / tiroir / drawer	

* graduable / réglable / adjustable

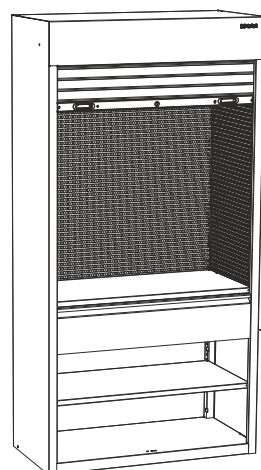

		L x A x H
159 P 5	114 Kg	1005 x 500 x 1980
componentes / composants / composants		
2x 159 P BG	* estanteria / étagère / shelf	
159 P PPF	panel / panneau / panel	
2x 159 P PPL	panel / panneau / panel	
159 P T50 C200	cajón / tiroir / drawer	

* graduable / réglable / adjustable
* paneles perforados/panneaux perforés/perforated panels

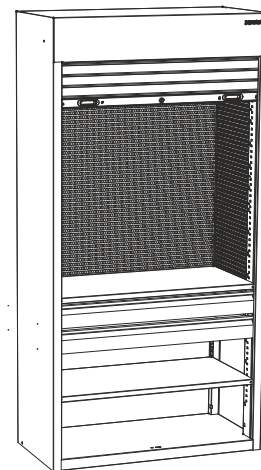



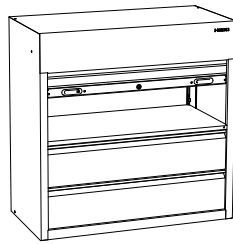

		L x A x H
159 P 6	112 Kg	1005 x 500 x 1980
componentes / composants / composants		
2x 159 P BG	* estanteria / étagère / shelf	
159 P PPF	panel / panneau / panel	
2x 159 P PPL	panel / panneau / panel	
2x 159 P T50 C100	cajón / tiroir / drawer	

* graduable / réglable / adjustable
* paneles perforados/panneaux perforés/perforated panels

SERIE 159 P B STANDARD





		L x A x H
159 P B 1	67 Kg	1005 x 500 x 1000

componentes / composants / components	
1x 159 P BG	* estanteria / étagère / shelf
2x 159 P T50 C100	cajón / tiroir / drawer  
1x 159 P T50 C200	cajón / tiroir / drawer  

* graduable / réglable / adjustable

		L x A x H
159 P B 2	64 Kg	1005 x 500 x 1000

componentes / composants / components	
1x 159 P BG	* estanteria / étagère / shelf
2x 159 P T50 C200	cajón / tiroir / drawer  

* graduable / réglable / adjustable

		L x A x H
159 P B 3	52 Kg	1005 x 500 x 1000

componentes / composants / components	
1x 159 P BG	* estanteria / étagère / shelf

* graduable / réglable / adjustable

SERIE 159 P COMPONENTES / COMPOSANTS / COMPONENTS

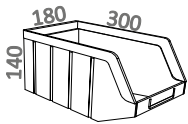

SERIE 157 CG
(7,56 l)
0,75 kg

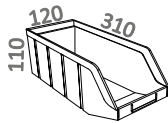

SERIE 157 CP
(4,92 l)
0,5 kg

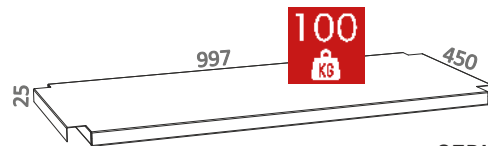

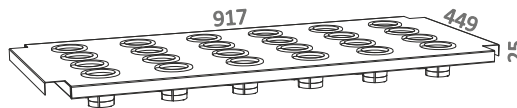

SERIE 159 P BG
4,7 kg
 1mm

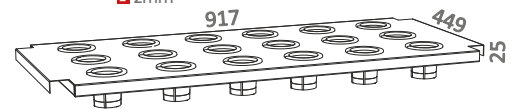
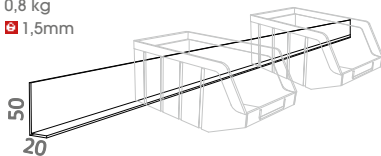

SERIE 159 P PC40
24x ISO40
9 kg
 2mm

SERIE 159 TC
0,8 kg
 1,5mm



SERIE 159 P PC50
18x ISO50
8,5 kg
 2mm

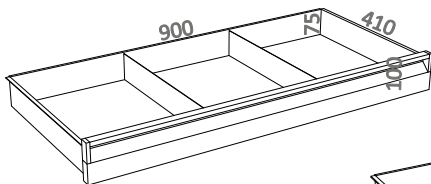

SERIE 159 P T50 C100
6,5 kg
 0,7mm
+2uni. SERIE 159 DP 100
Separador para cajón 100mm.
Séparateur pour tiroir 100mm.
Drawer 100mm divider.

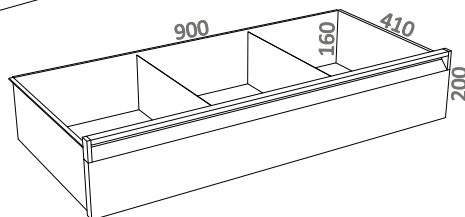

SERIE 159 P T50 C200
8,5 kg
 0,7mm
+2uni. SERIE 159 DP 200
Separador para cajón 200mm.
Séparateur pour tiroir 200mm.
Drawer 200mm divider.

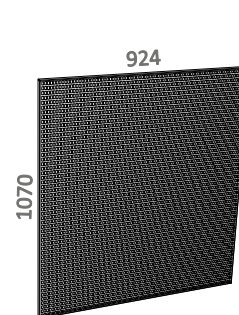

SERIE 159 P PPF
12 kg
 1,5mm



SERIE 159 P PPL
5 kg
 1,5mm



ACCESORIOS ver PAG. 285.
ACCESSOIRES, voir PAGE. 285.
ACCESSORIES, see PAGE. 285.

SERIE 159 F6

Armario 2 puertas
Armoire 2 portes
Cabinet with 2 doors

new



SERIE 159 F6

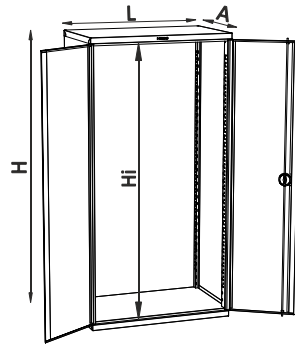

		L x A x H	Hi (mm)
159 F6	75 Kg	1000x600x1980	1865
159 F6 PV	76,8 Kg	1000x600x1980	1865

*armazón chasis / frame

1 mm

OPCIONAL OPTIONNEL / OPTIONAL

BANDEJA ETAGERE / SHELF

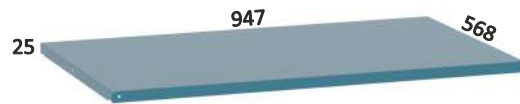

4 Kg

CAJÓN TIROIR / DRAWER

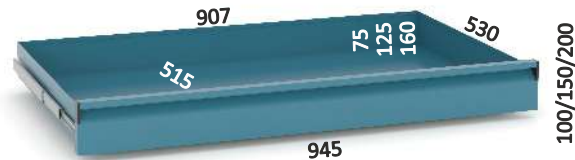

GT

50

Carga máxima repartida 50 Kg. Apertura total.
Charge maximum répartie 50 Kg. Ouverture totale.
Maximum distributed load 50 Kg. Complete opening.



Fondo (A) 600 mm.
Profondeur (A) 600 mm.
Depth (A) 600 mm.



Opcional. Ver: PAG 291.
Optionnel. Voir: PAG 291.
Optional. See: PAGE 291.

SERIE 159 2 F6 STANDARD

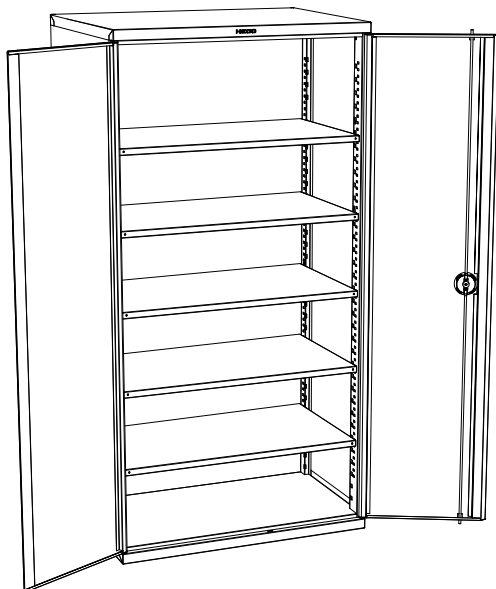

100

Carga por estanteria repartida.
Charge pour étagère répartie.
Distributed load for shelf.

		L x A x H
159 2 F6	102 Kg	1000 x 600 x 1980

componentes / composants / components

159 F6 BG 5 5x estanterias / étagères / shelves

159 F6 BG 6,3 Kg estanteria / étagère / shelf



Estanterias graduables cada 25mm.
Étagères réglables chaque 25mm.
Adjustable shelves every 25mm.

SERIE 162

Armario 2 puertas
Armoire 2 portes
Cabinet with 2 doors

new



SERIE 162

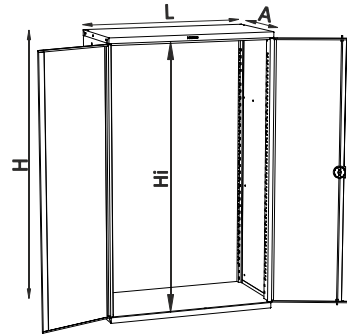

		L x A x H	Hi (mm)
162	90 Kg	1200x600x1980	1865
162 PV	90,8 Kg	1200x600x1980	1865

*armazón chasis / frame

e 1 mm

OPCIONAL OPTIONNEL / OPTIONAL

BANDEJA ETAGERE / SHELF

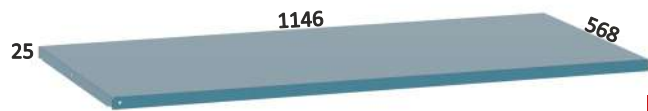

KG 6 Kg

CAJÓN TIROIR / DRAWER

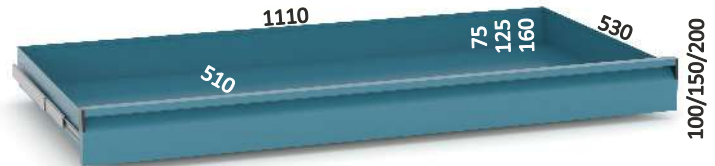

GT

50
KG

Carga máxima repartida 50 Kg. Apertura total.
Charge maximum répartie 50 Kg. Ouverture totale.
Maximum distributed load 50 Kg. Complete opening.

! Fondo (A) 600 mm.
Profondeur (A) 600 mm.
Depth (A) 600 mm.

≡ Opcional. Ver: PAG 291.
Optionnel. Voir: PAG 291.
Optional. See: PAGE 291.

SERIE 162 2 STANDARD

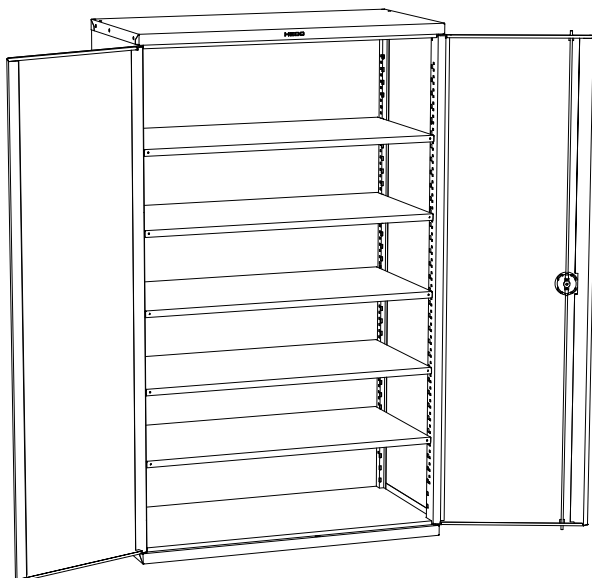

100
KG

Carga por estantería repartida.
Charge pour étagère répartie.
Distributed load for shelf.

		L x A x H
162 2	120 Kg	1200 x 600 x 1980

componentes / composants / components

162 BG 5	5x estanterías / étagères / shelves	
162 BG	7,6 Kg	estanterías / étagère / shelf



Estanterías graduables cada 25mm.
Étagères réglables chaque 25mm.
Adjustable shelves every 25mm.

SERIE V-420

Armario para cubetas V-FOX
Armoire pour bacs à bec V-FOX
Cabinet for V-FOX trays

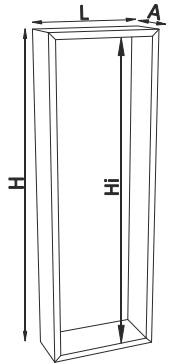

		L x A x H	Hi (mm)
V-420 H	42 Kg	670x250x2000	1920

e 1,5 mm



V-420 P

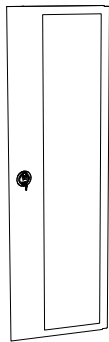

V-420 PV



accesorios / accessoires / accessories

V-420 P puerta / porte / door

V-420 PV puerta / porte / door



Opción con puerta de metacrilato.
Option avec porte de methacrylate.
Methacrylate door option.



Opcional. Ver: PAG 291.
Optionnel. Voir: PAG 291.
Optional. See: PAGE 291.

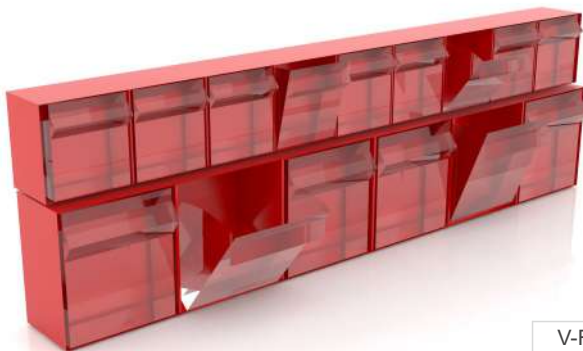

CUBETAS BACS A BEC / TRAYS

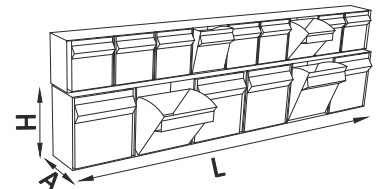

		cubetas casiers / trays		L x A x H	color couleur / colour	
V-FOX 101	0,65 Kg	9 u	0,12 l	600 x 68 x 76		
V-FOX 102	1,08 Kg	6 u	0,42 l	600 x 94 x 112		
V-FOX 103	1,90 Kg	5 u	1,2 l	600x 135 x 164		
V-FOX 104	2,80 Kg	4 u	2,4 l	600 x 177 x 206		
V-FOX 105	3,60 Kg	3 u	4,5 l	600 x 214 x 240		
V-FOX B	varilla de seguridad / tringle de sécurité / safety bar					



V-FOX ver PAG. 303.
V-FOX, voir PAGE. 303.
V-FOX, see PAGE. 303.

SERIE V-420 STANDARD



Carga por estantería repartida.
Charge pour étagère répartie.
Distributed load for shelf.

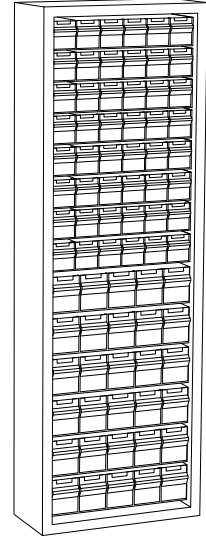
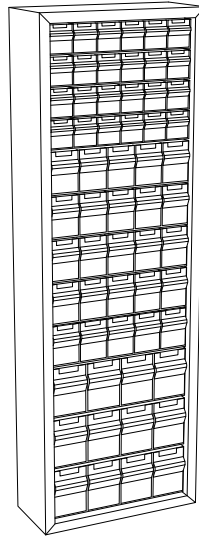
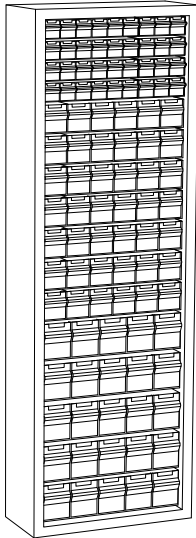

		L x A x H
V-420 H 1	61,66 Kg	670 x 250 x 2000
componentes / composants / components		
4x V-FOX 101	cubetas / casiers / trays	
7x V-FOX 102	cubetas / casiers / trays	
5x V-FOX 103	cubetas / casiers / trays	

		L x A x H
V-420 H 2	64,22 Kg	670 x 250 x 2000
componentes / composants / components		
4x V-FOX 102	cubetas / casiers / trays	
5x V-FOX 103	cubetas / casiers / trays	
3x V-FOX 104	cubetas / casiers / trays	

		L x A x H
V-420 H 3	60,04 Kg	670 x 250 x 2000
componentes / composants / components		
8x V-FOX 102	cubetas / casiers / trays	
6x V-FOX 103	cubetas / casiers / trays	

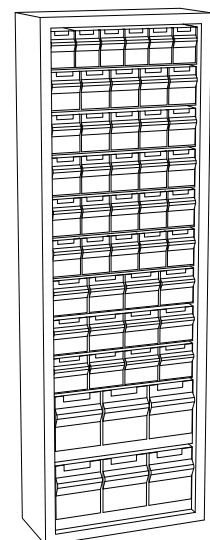
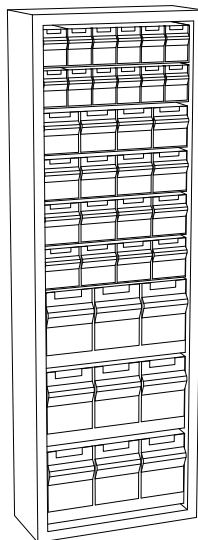
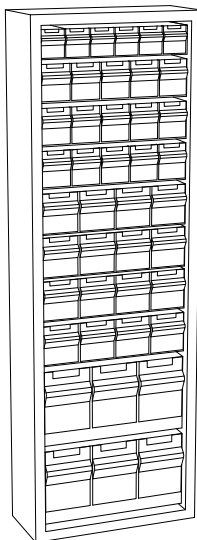

		L x A x H
V-420 H 4	67,18 Kg	670 x 250 x 2000
componentes / composants / components		
1x V-FOX 102	cubetas / casiers / trays	
3x V-FOX 103	cubetas / casiers / trays	
4x V-FOX 104	cubetas / casiers / trays	
2x V-FOX 105	cubetas / casiers / trays	

		L x A x H
V-420 H 5	67,8 Kg	670 x 250 x 2000
componentes / composants / components		
2x V-FOX 103	cubetas / casiers / trays	
4x V-FOX 104	cubetas / casiers / trays	
3x V-FOX 105	cubetas / casiers / trays	

		L x A x H
V-420 H 6	68,18 Kg	670 x 250 x 2000
componentes / composants / components		
1x V-FOX 102	cubetas / casiers / trays	
5x V-FOX 103	cubetas / casiers / trays	
3x V-FOX 104	cubetas / casiers / trays	
2x V-FOX 105	cubetas / casiers / trays	



V-FOX ver PAG. 303.
V-FOX, voir PAGE. 303.
V-FOX, see PAGE. 303.

SERIE V-ABULL

Armario para cubetas V-ABULL
Armoire pour bacs à bec V-ABULL
Cabinet for V-ABULL trays



V-ABULL 2 3

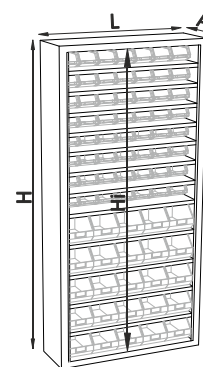

V-ABULL 4

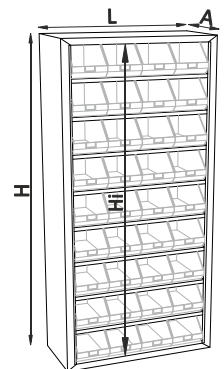

		L x A x H	Hi (mm)
V-ABULL 2 3	70 Kg	805x250x1780	1700
V-ABULL 4	85 Kg	805x350x1830	1750

1,5 mm

CUBETAS BACS A BEC / TRAYS

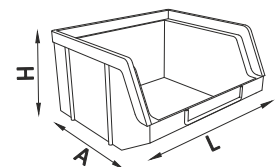

			L x A x H	color couleur / colour	
V-BULL 1	0,046 Kg	0,4 l	105 x 88 x 54		
V-BULL 2	0,110 Kg	1,2 l	105 x 167 x 82		
V-BULL 3	0,226 Kg	3,5 l	144 x 237 x 123		
V-BULL 4	0,638 Kg	9,1 l	205 x 345 x 164		



V-ABULL ver PAG. 302.
V-ABULL, voir PAGE. 302.
V-ABULL, see PAGE. 302.



BAJO PEDIDO: colores OPCIONALES
SOUS ORDRE: couleurs EN OPTION
OPTIONAL colors. UNDER ORDER

SERIE V-ABULL STANDARD



Carga por estantería repartida.
Charge pour étagère répartie.
Distributed load for shelf.

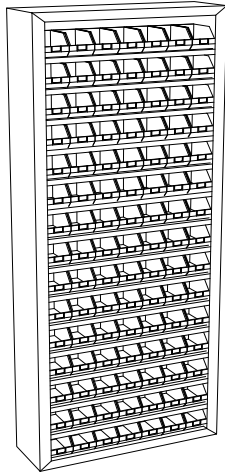

V-ABULL 2
7u. estante
étagère
shelf
x15 filas
lignes
rows
105 cubetas
casiers
trays

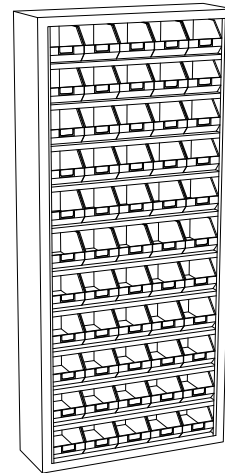

V-ABULL 3
5u. estante
étagère
shelf
x11 filas
lignes
rows
55 cubetas
casiers
trays

L x A x H		
V-ABULL 2	76 Kg	805 x 250 x 1780

componentes / composants / composants	
14x V-ABULL B	bandeja / étagère / shelf
105x V-BULL 2	cubetas / casiers / trays

*14 estantes étagères / shelves

L x A x H		
V-ABULL 3	64 Kg	805 x 250 x 1780

componentes / composants / composants	
10x V-ABULL B	bandeja / étagère / shelf
55x V-BULL 3	cubetas / casiers / trays

*10 estantes étagères / shelves

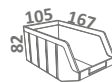
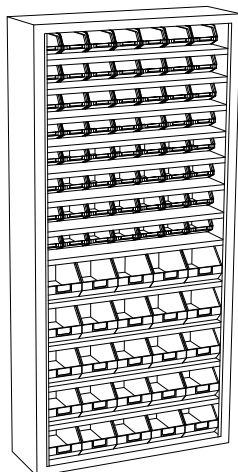

V-ABULL 2
7u. estante
étagère
shelf
x 8 filas
lignes
rows
56 cubetas
casiers
trays

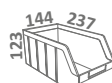

V-ABULL 3
5u. estante
étagère
shelf
x 5 filas
lignes
rows
25 cubetas
casiers
trays

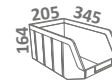
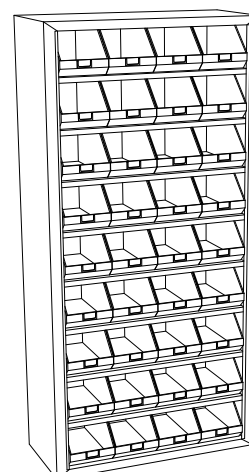

V-ABULL 4
4u. estante
étagère
shelf
x 9 filas
lignes
rows
36 cubetas
casiers
trays

L x A x H		
V-ABULL 2 3	70 Kg	805 x 250 x 1780

componentes / composants / composants	
12x V-ABULL B	bandejas / étagères / shelves
56x V-BULL 2	cubetas / bacs à bec / trays
25x V-BULL 3	cubetas / bacs à bec / trays

*12 estantes étagères / shelves

L x A x H		
V-ABULL 4	85 Kg	895 x 350 x 1830

componentes / composants / composants	
8x V-ABULL 4 B	bandejas / étagères / shelves
36x V-BULL 4	cubetas / bacs à bec / trays

*8 estantes étagères / shelves



Distribué par :



V-BULL ver PAG. 302.
V-BULL, voir PAGE. 302.
V-BULL, see PAGE. 302.