

ARMOIRES INFORMATIQUES

PC WORKSTATIONS



FR

- Armoire modulaire pour PC.
- Pour écrans plats jusqu'à 26".
- Configurez votre armoire en fonction de vos besoins.
- Disponible avec ou sans roues.
- Données électrique et Internet disponible.
- Couleur standard bleu martelé (SÉRIE 105) et RAL 7016 - RAL 5010 (SÉRIE 103 - 104).
- Matériel informatique non fournis.

EN

- Modular cabinet for PC.
- For flat screens up to 26".
- Configure your cabinet according to your needs.
- Available with or without wheels.
- Available with electrical and data connections.
- Standard colour hammered blue (SERIE 105) and RAL 7016 - RAL 5010 (SERIE 103 - 104).
- Informatic material not supplied.

ARMARIOS PC



ES

- Armario modular para PC.
- Para pantallas planas de hasta 26".
- Configure su armario según sus necesidades.
- Disponible con o sin ruedas.
- Disponible conexiones eléctricas y de datos.
- Color estándar azul martelé (SERIE 105) y RAL 7016- RAL 5010 (SERIE 103-104).
- Material informático no se suministra.



www

SERIE 103 ref. 103 1 - 103 2 - 103 3 - 103 4 / 103 1 P-103 2 P

Armario PC opción con puerta o persiana.
Armoire PC option avec porte ou rideau.
PC cabinet with door or shutter closure.



SERIE 103 1

SERIE 103 1 P



103 1/2/3/4

Puerta de metacrilato y configuración estándar.
Porte en méthacrylate et configuration standard.
Methacrylate door and standard configuration.

103 1 P/103 2 P

Persiana y configuración estándar.
Rideau et configuration standard.
Shutter closure and standard configuration.

PIES PIEDS STANDS

Base redonda regulable en altura.
Base ronde réglable en hauteur.
Height-adjustable round base.



Asa en cada lado.
Poignée de chaque côté.
Handle on each side.

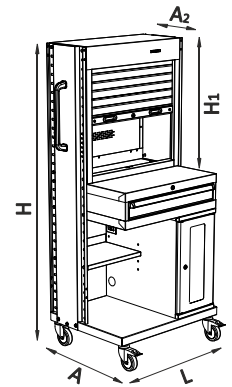
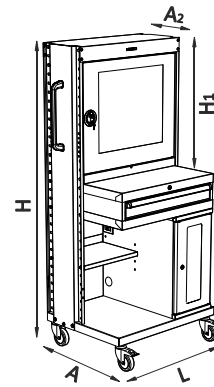

RUEDAS ROUES WHEELS

Ø 100 mm
H 135 mm



COLORES COULEURS COLOURS

Colores estándar (según serie).
Couleurs standard (selon série).
Standard colours (as shown above).

RAL 5010
RAL 7016



Para otros colores hay un coste adicional.
Pour d'autres couleurs il y a un coût additionnel.
For other colors, there is an additional cost.

	L x A x H	A ₂	H ₁
103 1	760x600x1740	300	745
103 2	760x600x1740	300	745
103 3	760x600x1740	300	745
103 4	760x600x1740	300	745
103 1 P	760x600x1740	300	745
103 2 P	760x600x1740	300	745



Kit electricidad (4 tomas 220V + ventilador + datos + magnetotérmico). Según opción.
Kit électricité (4 prises 220V + ventilateur + données + magnéto thermique). Selon option.
Power kit (4 220V plugs + fan + data point + thermal magneto). According to option.



Equipo informático no incluido.
Équipement informatique non inclus.
Computer equipment not included.



Armario para pantalla hasta 26".
Armoire pour écran jusqu'à 26".
Computer monitor cabinet up to 26".



1,5 mm laterales latéraux / laterals



1 mm estructura chasis / frame



0,6 mm puertas portes / doors

SERIE 103 STANDARD

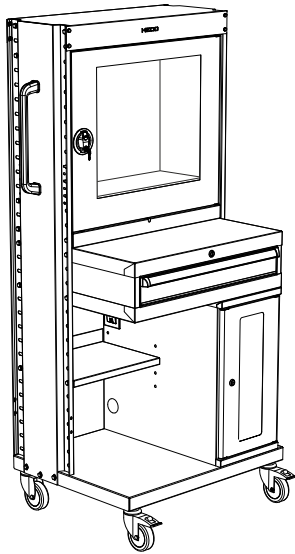

L x A x H		
103 1	75 Kg	760 x 600x 1740

componentes / composants / components	
103	estructura / châssis / frame
103 001	armario pantalla/ armoire écran / screen cabinet
103 002	cajón / tiroir / drawer
103 003 PV	armario CPU/ armoire CPU / CPU cabinet
103 006	bandeja regulable / plateau réglable / adjustable shelf
103 008	4 ruedas / 4 roues / 4 wheels
149 004	2 asas / 2 poignées / 2 handles



Kit electricidad incluido.
Kit électricité inclus.
Included power kit.

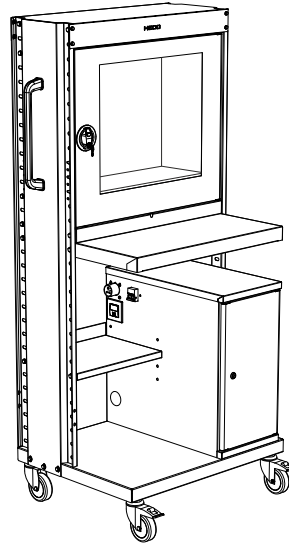

L x A x H		
103 2	55 Kg	760 x 600x 1740

componentes / composants / components	
103	estructura / châssis / frame
103 001	armario pantalla/ armoire écran / screen cabinet
103 003	armario CPU/ armoire CPU / CPU cabinet
103 004	plano de trabajo/ plan de travail / worktop
103 006	bandeja regulable / plateau réglable / adjustable shelf
103 008	4 ruedas / 4 roues / 4 wheels
149 004	2 asas / 2 poignées / 2 handles



Kit electricidad incluido.
Kit électricité inclus.
Included power kit.

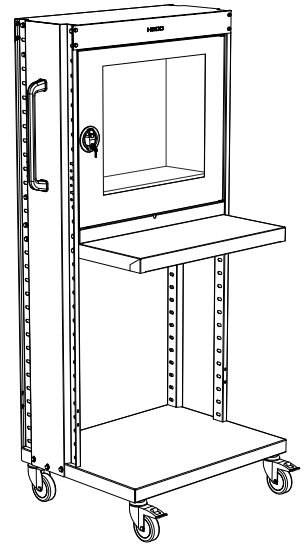

L x A x H		
103 3	45 Kg	760 x 600x 1740

componentes / composants / components	
103	estructura / châssis / frame
103 001	armario pantalla/ armoire écran / screen cabinet
103 004	plano de trabajo/ plan de travail / worktop
103 007	refuerzo / renfort / reinforcement
103 008	4 ruedas / 4 roues / 4 wheels
149 004	2 asas / 2 poignées / 2 handles

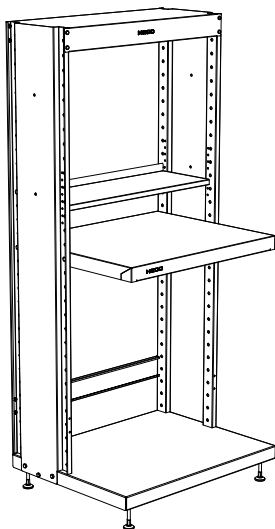

L x A x H		
103 4	33 Kg	760 x 600x 1740

componentes / composants / components	
103	estructura / châssis / frame
103 004	plano de trabajo/ plan de travail / worktop
103 005	bandeja regulable/ plateau réglable / adjustable shelf
103 007	refuerzo / renfort / reinforcement
103 009	4 patas regulables / 4 pieds réglables / 4 adjustable legs

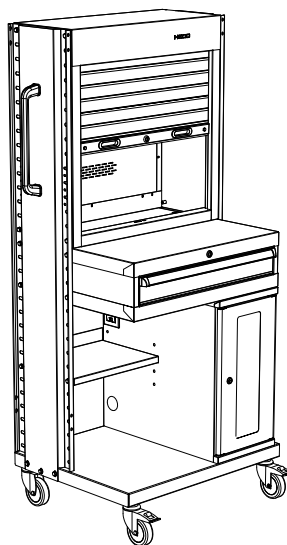

L x A x H		
103 1 P	60 Kg	760 x 600x 1740



Kit electricidad incluido.
Kit électricité inclus.
Included power kit.

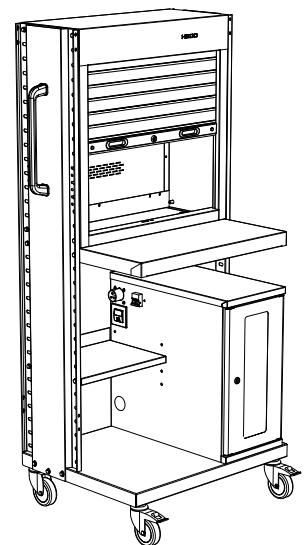

L x A x H		
103 2 P	60 Kg	760 x 600x 1740



Kit electricidad incluido.
Kit électricité inclus.
Included power kit.

SERIE 104 ref. 104 0 / 104 1

Armario PC opción con puerta o persiana.
Armoire PC option avec porte ou rideau.
PC cabinet with option door or shutter closure.



SERIE 104 0



SERIE 104 1



104 0

Puerta de metacrilato.
Porte de méthacrylate.
Methacrylate door.

P₁ 700mm

PIES PIEDS STANDS

Base redonda regulable en altura.
Base ronde réglable en hauteur.
Height-adjustable round base.



GUIAS GLISSIERES SLIDES



Bandeja extensible y cajón
Plateau amovible et tiroir
Removable tray and drawer

Carga máxima repartida 50 Kg. Apertura total.
Charge maximum répartie 50 Kg. Ouverture totale.
Maximum distributed load 50 Kg. Complete opening.

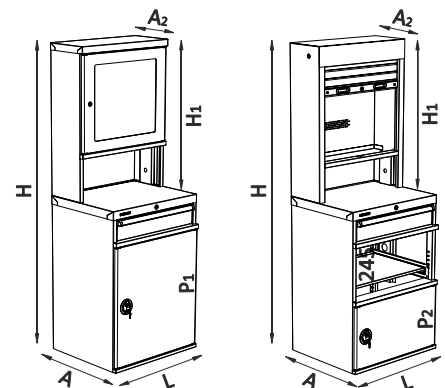

104 1

Persiana y bandeja extraíble.
Rideau et plateau amovible.
Shutter closure and removable tray.

P₂ 370mm

RUEDAS ROUES WHEELS

Ø 100 mm
H 135 mm



COLORES COULEURS COLOURS

Colores estándar (según serie).
Couleurs standard (selon série).
Standard colours (according to series).

RAL 5010
RAL 7016



Para otros colores hay un coste adicional.
Pour d'autres couleurs il y a un coût additionnel.
For others colours there is an additional cost.

	L x A x H	A ₂	H ₁
104 0	650x545x1800	270	870
104 0 P	650x545x1880	270	870
104 0 R	650x545x1935	270	870
104 1	650x545x1800	250	870
104 1 P	650x545x1880	250	870
104 1 R	650x545x1935	250	870



Kit electricidad (4 tomas 220V + ventilador + datos + magnetotérmico). Incluido.
Kit électricité (4 prises 220V + ventilateur + données + magnéto thermique). Inclus.
Power kit (4 220V plugs + fan + data point + thermal magneto). Included.



1 mm estructura chassis / frame



0,6 mm puertas portes / doors



Equipo informático no incluido.
Équipement informatique non inclus.
Computer equipment not included.

SERIE 104 STANDARD

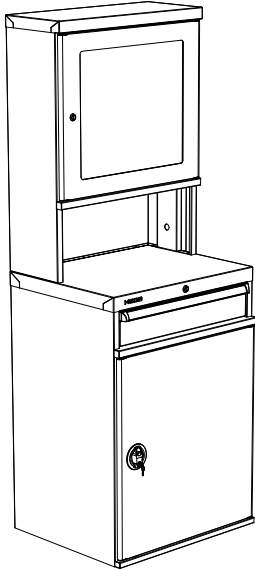

		LxAxH
104 0	67,75 Kg	650 x 545 x 1800

* Base Base / Base board



Kit electricidad incluido.
Kit électricité inclus.
Included power kit.

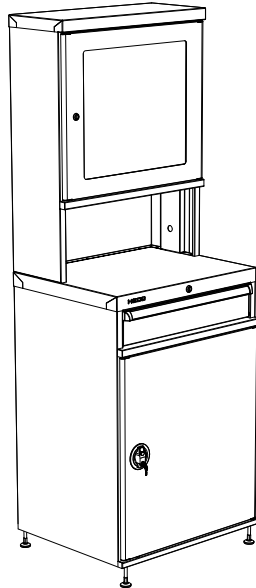

		LxAxH
104 0 P	68,25 Kg	650 x 545 x 1880

*Patas Pieds / Stands



Kit electricidad incluido.
Kit électricité inclus.
Included power kit.

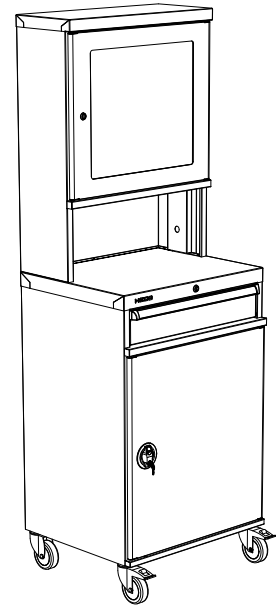

		LxAxH
104 0 R	69,75 Kg	650 x 545 x 1935

*Ruedas Roues / Wheels



Kit electricidad incluido.
Kit électricité inclus.
Included power kit.

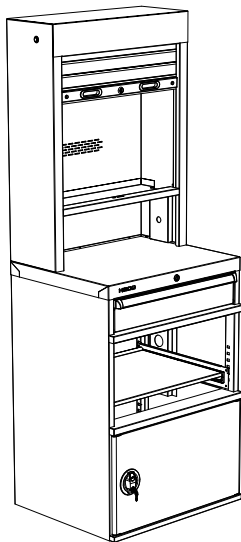

		LxAxH
104 1	72 Kg	650 x 545 x 1800

* Base Base / Base board



Kit electricidad incluido.
Kit électricité inclus.
Included power kit.

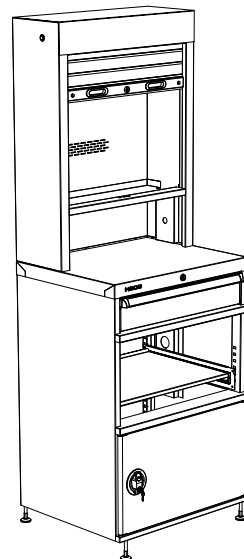

		LxAxH
104 1 P	72,5 Kg	650 x 545 x 1880

*Patas Pieds / Stands



Kit electricidad incluido.
Kit électricité inclus.
Included power kit.

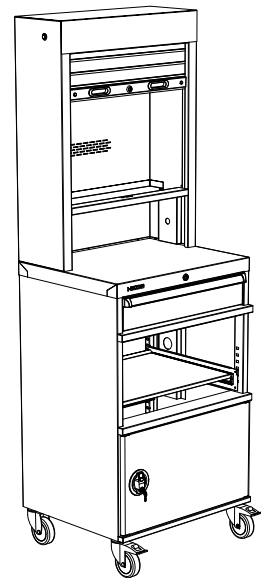

		LxAxH
104 1 R	74 Kg	650 x 545 x 1935

*Ruedas Roues / Wheels



Kit electricidad incluido.
Kit électricité inclus.
Included power kit.

SERIE 104 0 1

Armario PC opción con persiana.
Armoire PC option avec rideau.
PC cabinet with shutter closure.



SERIE 104 0 1

RUEDAS ROUES WHEELS

Ø 100 mm
H 135 mm



PIES PIEDS STANDS

Base redonda regulable en altura.
Base ronde réglable en hauteur.
Height-adjustable round base.

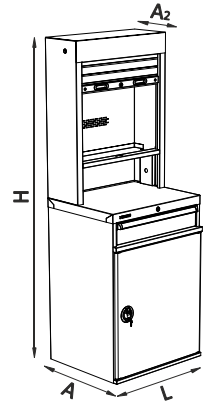

	L x A x H	A ₂
104 0 1	650x545x1800	250
104 0 1 P	650x545x1880	250
104 0 1 R	650x545x1935	250

e 1 mm estructura chasis / frame

e 0,6 mm puertas portes / doors

COLORES COULEURS COLOURS

Colores estándar (según serie).
Couleurs standard (selon série).
Standard colours (according to series).

RAL 5010
RAL 7016



Equipo informático no incluido.
Équipement informatique non inclus.
Computer equipment not included.



Kit electricidad (4 tomas 220V + ventilador + datos + magnetotérmico). Incluido.
Kit électricité (4 prises 220V + ventilateur + données + magnéto thermique). Inclus.
Power kit (4 220V plugs + fan + data point + thermal magneto). Included.

SERIE 104 STANDARD

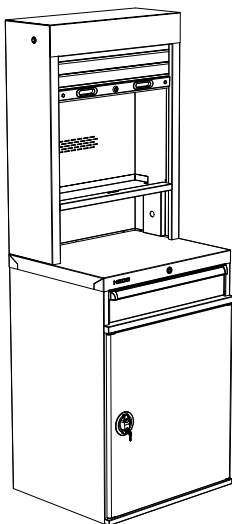

	L x A x H
104 0 1	76,1 Kg 650 x 545 x 1800

* Base Base / Base board



Kit electricidad incluido.
Kit électricité inclus.
Included power kit.

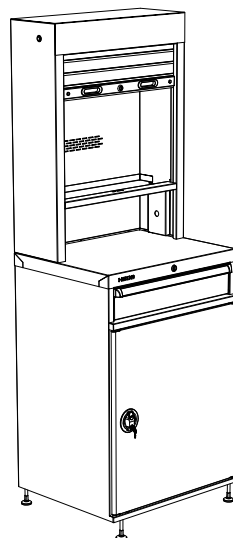

	L x A x H
104 0 1 P	76,6 Kg 650 x 545 x 1880

* Patas Pieds / Stands



Kit electricidad incluido.
Kit électricité inclus.
Included power kit.

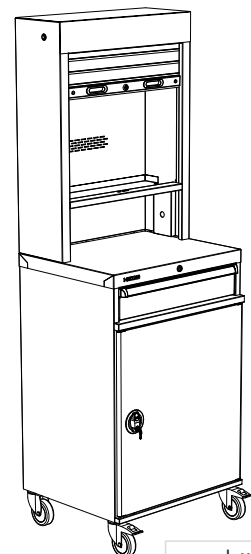

	L x A x H
104 0 1 R	78,1 Kg 650 x 545 x 1935

* Ruedas Roues / Wheels



Kit electricidad incluido.
Kit électricité inclus.
Included power kit.

SERIE 104 1 0

Armario PC opción con puerta de metacrilato y bandeja extraíble.
Armoire PC option avec porte de méthacrylate et plateau amovible.
PC cabinet with methacrylate door and removable tray.



SERIE 104 1 0

RUEDAS ROUES WHEELS

Ø 100 mm
H 135 mm



PIES PIEDS STANDS

Base redonda regulable en altura.
Base ronde réglable en hauteur.
Height-adjustable round base.

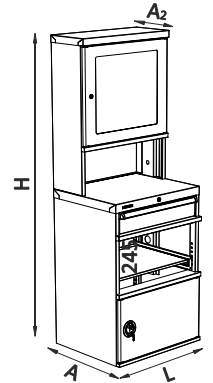

	L x A x H	A ₂
104 1 0	650x545x1800	270
104 1 0 P	650x545x1880	270
104 1 0 R	650x545x1935	270

e 1 mm estructura chasis / frame

e 0,6 mm puertas portes / doors

COLORES COULEURS COLOURS

Colores estándar (según serie).
Couleurs standard (selon série).
Standard colours (according to series).

RAL 5010
RAL 7016



Equipo informático no incluido.
Équipement informatique non inclus.
Computer equipment not included.



Kit electricidad (toma 220V + ventilador + datos + magnetotérmico). Incluido.
Kit électricité (prise 220V + ventilateur + données + magnéto thermique). Inclus.
Power kit (220V plug + fan + data point + thermal magneto). Included.

SERIE 104 STANDARD

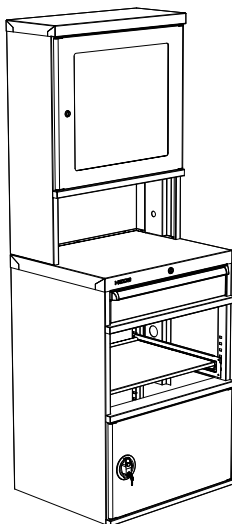

	L x A x H
104 1 0	70 Kg 650 x 545 x 1800

* Base Base / Base board



Kit electricidad incluido.
Kit électricité inclus.
Included power kit.

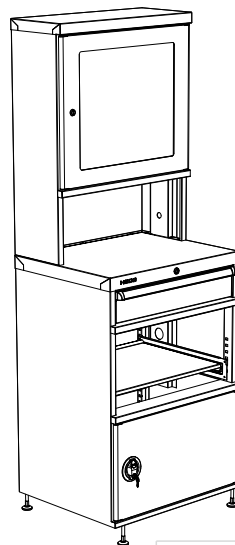

	L x A x H
104 1 0 P	70,5 Kg 650 x 545 x 1880

* Patas Píeds / Stands



Kit electricidad incluido.
Kit électricité inclus.
Included power kit.

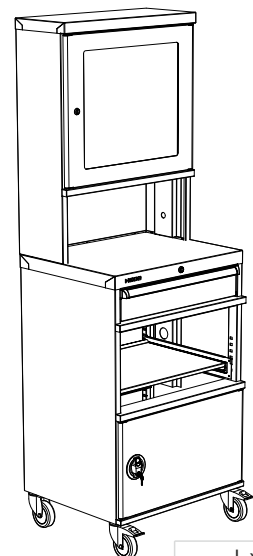

	L x A x H
104 1 0 R	72 Kg 650 x 545 x 1935

* Ruedas Roues / Wheels



Kit electricidad incluido.
Kit électricité inclus.
Included power kit.

Armario PC con puertas.
Armoire PC avec portes.
PC cabinet with doors.

SERIE 105 1

SERIE 105 2

105 1

Bandejas graduables cada 25 mm.
Étagères réglables chaque 25 mm.
Adjustable shelves every 25 mm.

105 2

Bandejas extraíbles.
Plateaux amovibles.
Removable tray.

GUIAS GLISSIERES SLIDES

Bandeja extensible y cajón
Plateau amovible et tiroir
Removable tray and drawer



Carga máxima repartida 50 Kg.
Charge maximum répartie 50 Kg.
Maximum distributed load 50 Kg.
Apertura total 100%.
Ouverture totale 100%.
Total opening 100%.

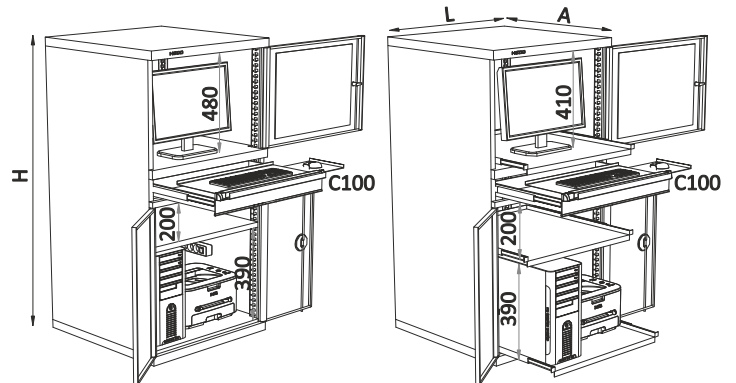

105 1

105 2

RUEDAS ROUES WHEELS

Ø 100 mm
H 135 mm

COLORES COULEURS COLOURS

Color estándar (según serie).
Couleur standard (selon série).
Standard colour (according to series).

**AZUL
MARTELÉ**



Para otros colores hay un coste adicional.
Pour d'autres couleurs il y a un coût additionnel.
For others colours there is an additional cost.

	L x A x H
105 1	714x730x1400
105 1 Z	714x730x1450
105 1 R	714x730x1500
105 2	714x730x1400
105 2 Z	714x730x1450
105 2 R	714x730x1500



Kit electricidad (toma 220V + ventilador + datos + magnetotérmico). Incluido.
Kit électricité (prise 220V + ventilateur + données + magnéto thermique). Inclus.
Power kit (220V plug + fan + data point + thermal magneto). Included.



Equipo informático no incluido.
Équipement informatique non inclus.
Computer equipment not included.

e 1 mm estructura chassis / frame

e 0,6 mm puertas portes / doors

SERIE 105 STANDARD



		LxAxH
105 1	72 Kg	714 x 730 x 1400



Kit electricidad incluido.
Kit électricité inclus.
Included power kit.



		LxAxH
105 1 Z	80 Kg	714 x 730 x 1450



Kit electricidad incluido.
Kit électricité inclus.
Included power kit.

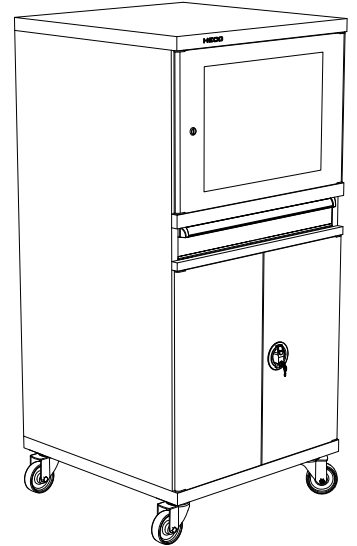

		LxAxH
105 1 R	95Kg	714 x 730 x 1535



Kit electricidad incluido.
Kit électricité inclus.
Included power kit.



		LxAxH
105 2	102 Kg	714 x 730 x 1400



Kit electricidad incluido.
Kit électricité inclus.
Included power kit.



		LxAxH
105 2 Z	110 Kg	714 x 730 x 1450



Kit electricidad incluido.
Kit électricité inclus.
Included power kit.



		LxAxH
105 2 R	125Kg	714 x 730 x 1535



Kit electricidad incluido.
Kit électricité inclus.
Included power kit.